



**HAL**  
open science

## The proving process within a dynamic geometry environment

Federica Olivero

► **To cite this version:**

| Federica Olivero. The proving process within a dynamic geometry environment. 2003. hal-00190412

**HAL Id: hal-00190412**

**<https://telearn.hal.science/hal-00190412>**

Submitted on 23 Nov 2007

**HAL** is a multi-disciplinary open access archive for the deposit and dissemination of scientific research documents, whether they are published or not. The documents may come from teaching and research institutions in France or abroad, or from public or private research centers.

L'archive ouverte pluridisciplinaire **HAL**, est destinée au dépôt et à la diffusion de documents scientifiques de niveau recherche, publiés ou non, émanant des établissements d'enseignement et de recherche français ou étrangers, des laboratoires publics ou privés.

University of Bristol, Graduate School of Education

# THE PROVING PROCESS WITHIN A DYNAMIC GEOMETRY ENVIRONMENT

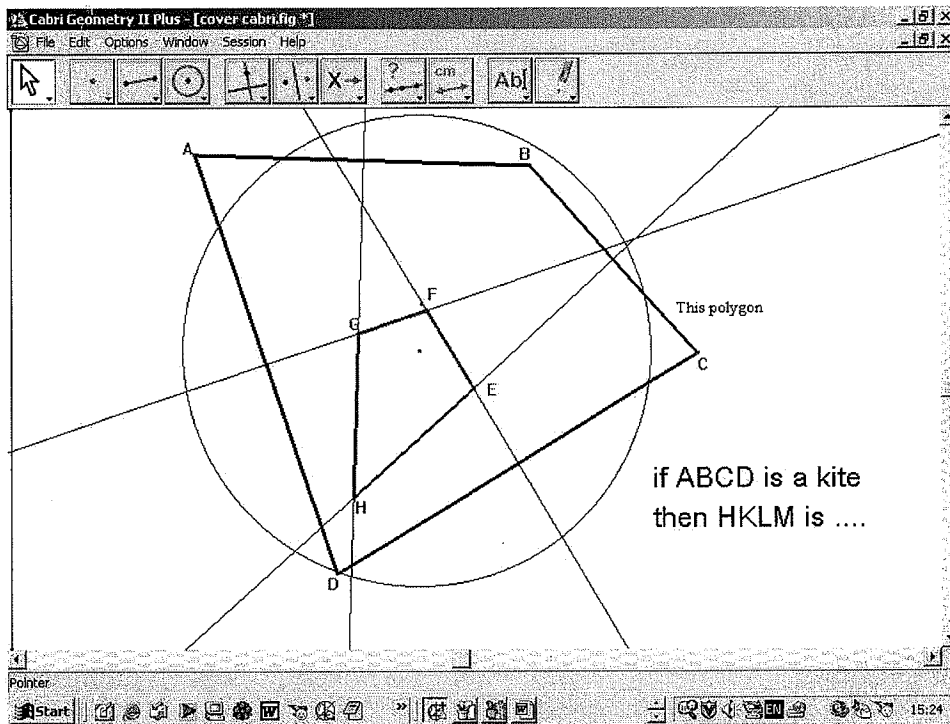

**Federica Olivero**

**PhD thesis**

A dissertation submitted to the University of Bristol in accordance  
with the requirements of the degree of Doctor of Philosophy in the  
Graduate School of Education – October 2002

**Advisor: Rosamund Sutherland**

**Examiners: Celia Hoyles and Jan Winter**

**ISBN No. 0-86292-535-5**

**“To travel hopefully is a better thing  
than to arrive”**

**Robert Louis Stevenson**

## ABSTRACT

Proof and proving have been objects of investigation from the point of view of mathematics and mathematics education for the past few years. Historical and epistemological studies show that proof is a crucial activity within mathematical practice. Didactical studies show that students encounter many difficulties when approaching proving in the classroom. Research at a cognitive level has developed frameworks interpreting students' difficulties. Studies concerned with the use of new technologies have been investigating the use of tools to support students with proving. In particular, a strand of research has studied specifically the impact of dynamic geometry software with respect to the teaching and learning of proving in geometry.

The main difficulty with respect to proof and proving that emerges from current research is the gap between empirical and theoretical elements involved with these activities. This study addressed the problem of how a dynamic geometry software (Cabri) may support students in managing the relationship between the spatio-graphical (empirical) field and the theoretical field.

Through a detailed analysis of students' processes when working with open geometry problems involving conjecturing and proving in Cabri, an analytical and explanatory framework has been developed. This framework also takes into account interactions between the students and the tools used and between the students themselves.

The research findings suggest that proving within a dynamic geometry environment develops as a *focusing process*, in which the shifts between ascending and descending processes between the spatio-graphical and the theoretical field appear to be key elements for the construction of conjectures and proofs. The analysis also shows that Cabri works as a *shared workspace*, i.e. as a space which supports the interaction between students' internal contexts and the construction of shared knowledge.

---

## ACKNOWLEDGEMENTS

A big *thank you!* to all the people who shared with me the long 'PhD journey', from beginning to end. It has been a very absorbing experience through which I certainly learnt a lot!

Ros, thank you very much for making the journey a very interesting learning experience and in particular for giving me the opportunity to develop "my own voice".

Thanks to my examiners, Celia and Jan, for making my "viva" an inspiring, stimulating and intense experience. I enjoyed it a lot!

Susie and Sally, thanks for sharing your academic (and non academic) experience and for saying that "everything is part of the process". Mary, thanks for being there all the time, until the very last end!

Ferdinando, Ornella and Domingo, thank you for your support and enthusiasm in 'initiating' me into the world of mathematics education, research, proof, Cabri: that's where it all began!

Thanks to Ernesto, Gerardo, Catia, Bibi, Chirp, Ed, Alex, Shannon and all my other 'Bristolian' friends with whom I shared the 'ups and downs' of this journey, inside and outside the department, face-to-face and at a distance.

A big thanks to Lolis and Costanza, for making it not a solitary journey and for travelling with me, always.

Thanks to all my Italian friends for their wonderful support 'at a distance' and for always being there to 'listen' to me. A particular thank you to Fra', Franci, Laura, Manuela, Maria, Miki, Simona...

Thanks to mum and dad, for making sure I could always do what I liked and for being happy with me.

Thanks to all teachers and students who worked with me.

Thanks to the Economic and Social Research Council and to the Department of Mathematics (University of Turin, Italy) for their economic support.

## **AUTHOR'S DECLARATION**

I declare that the work in this dissertation was carried out in accordance with the Regulations of the University of Bristol. The work is original except where indicated by special reference in the text and no part of the dissertation has been submitted for any other degree.

Any views expressed in the dissertation are those of the author and in no way represent those of the University of Bristol.

The dissertation has not been presented to any other University for examination either in the United Kingdom or overseas.

SIGNED: *Federico Ghivens*

DATE: *18/10/2002*

---

# CONTENTS

<b>ABSTRACT .....</b>	<b>i</b>
<b>ACKNOWLEDGEMENTS .....</b>	<b>ii</b>
<b>AUTHOR'S DECLARATION .....</b>	<b>iii</b>
<b>CONTENTS .....</b>	<b>iv</b>
<b>CHAPTER 1. INTRODUCTION.....</b>	<b>1</b>
1.1    SETTING THE PROBLEM .....	1
1.2    BACKGROUND OF THE AUTHOR.....	3
1.2.1    School experience.....	3
1.2.2    Experience with mathematics education.....	4
1.3    AIMS AND RESEARCH QUESTIONS.....	6
1.4    OVERVIEW OF THE STUDY .....	8
<b>CHAPTER 2. PROOF AND PROVING: A DEBATE.....</b>	<b>10</b>
2.1    INTRODUCTION.....	10
2.2    DEFINING THE ROLE AND FUNCTION OF PROOF.....	11
2.2.1    The three revolutions.....	12
2.2.2    Different meanings and functions for proving.....	15
2.2.3    Experimenting, exploring, conjecturing and proving .....	19
2.3    PROOF IN THE CURRICULUM .....	22
2.4    TEACHING AND LEARNING PROOF IN THE CLASSROOM .....	26
2.4.1    The learning perspective.....	26
2.4.2    The teaching perspective .....	29
2.5    COGNITIVE THEORETICAL FRAMEWORKS AND TEACHING EXPERIMENTS.....	32
2.5.1    A transition from empirical to deductive proof.....	32
2.5.2    Argumentation and proof: two different cognitive functionings .....	35
2.5.3    Alternative views: an interplay among different types of reasoning .....	38
2.6    THE PROVING PROCESS.....	41
2.7    SUMMARY.....	42
<b>CHAPTER 3. NEW TECHNOLOGIES IN MATHEMATICS EDUCATION .....</b>	<b>45</b>
3.1    INTRODUCTION.....	45
3.2    WORKING AND INTERACTING <i>WITH</i> NEW TECHNOLOGIES .....	46
3.2.1    Microworlds .....	47

3.2.2	Amplifiers or reorganisers?.....	48
3.2.3	The instrumental approach.....	49
3.2.4	Semiotic mediation .....	50
3.3	INTERACTING AT NEW TECHNOLOGIES .....	51
3.3.1	Entering another's universe of thought.....	52
3.3.2	The role of the computer in constructing shared knowledge in students' interactions .....	53
3.4	THE CASE OF DYNAMIC GEOMETRY SOFTWARE .....	57
3.4.1	Dragging in Cabri .....	58
3.4.2	Spatio-graphical field and theoretical field in Cabri .....	61
3.4.3	Cabri and proving .....	63
3.4.4	Dragging and proving: a possible theoretical model?.....	66
3.5	SUMMARY .....	69
<b>CHAPTER 4. THE TEACHING AND LEARNING CONTEXT .....</b>		<b>71</b>
4.1	INTRODUCTION.....	71
4.2	THE ENGLISH SETTING.....	72
4.2.1	The subjects involved .....	72
4.2.2	Aims of the intervention .....	72
4.3	THE ITALIAN SETTING.....	74
4.3.1	The subjects involved .....	74
4.3.2	Aims of the intervention .....	75
4.4	THE KEY ELEMENTS OF THE TEACHING AND LEARNING CONTEXT.....	76
4.4.1	Open problems in Cabri.....	76
4.4.2	The classroom sessions .....	77
4.4.3	Working in pairs at the computer.....	78
4.5	SUMMARY .....	78
<b>CHAPTER 5. THE RESEARCH PROCESS .....</b>		<b>79</b>
5.1	INTRODUCTION.....	79
5.2	IMPLICATIONS OF AN EXPLORATORY STUDY.....	80
5.3	CHOOSING A METHODOLOGY.....	81
5.4	THE STUDENTS INVOLVED .....	82
5.5	THE RESEARCH INSTRUMENTS .....	85
5.6	COLLECTING DATA .....	86
5.6.1	Video-recording.....	86
5.6.2	Fieldnotes.....	87
5.6.3	Collection of material .....	87
5.6.4	Data collected .....	87
5.6.5	The role of the researcher .....	88
5.7	ANALYSING THE DATA .....	90
5.7.1	Data reduction.....	91
5.7.2	The continual process of analysis .....	93



5.8	A PRELIMINARY ANALYTICAL FRAMEWORK.....	97
5.8.1	The starting point: a categorisation of dragging modalities.....	97
5.8.2	A priori categories of analysis .....	98
5.8.3	New categories emerged from the data.....	100
5.9	RELIABILITY, VALIDITY AND GENERALISABILITY.....	101
5.10	ETHICAL ISSUES .....	102
5.11	THE OVERALL RESEARCH PROCESS.....	102
<b>CHAPTER 6. THE STORY OF BARTOLOMEO AND TIZIANA.....</b>		<b>104</b>
6.1	INTRODUCTION.....	104
6.2	THE CONTEXT.....	105
6.3	THE PROVING PROCESS OF BARTOLOMEO AND TIZIANA.....	106
6.3.1	Episode 1. Constructing the figure .....	106
6.3.2	Episode 2. Starting to explore. Formulating a conjecture about the parallelogram (C1).....	106
6.3.3	Episode 3. Exploring the case of the point (C2) and the case of the trapezium (C3) .....	107
6.3.4	Episode 4. Proving the case of the parallelogram (P1).....	108
6.3.5	Episode 5. The case of the rhombus (C4).....	109
6.3.6	Episode 6. Proving the case of the point inside (C2).....	109
6.3.7	Episode 7. Exploring and proving the case of the right-angled trapezium (C5 & P5) and the case of similar quadrilaterals (C8).....	110
6.3.8	Episode 8. Exploring and proving the case of the isosceles trapezium (C6) and the case of the rhombus (C4).....	110
6.3.9	Episode 9. Formulating of a general conjecture about cyclic quadrilaterals (C7) .....	111
6.3.10	Episode 10. Concluding with a general conjecture (C9) .....	112
6.3.11	Summary of conjectures and proofs .....	114
6.4	TELLING THE STORY OF BARTOLOMEO AND TIZIANA AND THEIR PROVING PROCESS.....	117
6.4.1	The use of dragging .....	117
6.4.2	The use of construction elements.....	121
6.4.3	The use of paper sketches .....	123
6.4.4	Types of statements .....	125
6.4.5	Interactions between students and Cabri .....	126
6.4.6	Interactions between students .....	126
6.4.7	Interplay between the spatio-graphical field (SG) and the theoretical field (T) .....	129
6.5	KEY ELEMENTS IN THE PROVING PROCESS OF BARTOLOMEO AND TIZIANA.....	131
6.6	SUMMARY .....	133
<b>CHAPTER 7. DEVELOPING AN ANALYTICAL FRAMEWORK.....</b>		<b>135</b>
7.1	INTRODUCTION.....	135
7.2	DEVELOPING AN ANALYTICAL FRAMEWORK .....	135
7.3	TYPE A CATEGORIES - TRANSFORMATIONS ON OBJECTS .....	137
7.3.1	(DM) Dragging modalities .....	138
7.3.2	(C) Hiding and showing construction elements.....	141

7.3.3	(SK) Thinking sketches and proof sketches.....	142
7.4	TYPE B CATEGORIES - TRANSFORMATIONS ON STATEMENTS.....	143
7.4.1	(ST) Types of statements .....	144
7.5	TYPE C CATEGORIES - MANAGING THE TRANSFORMATIONS ON OBJECTS AND STATEMENTS .....	145
7.5.1	(SC) Emergent and planned interaction with Cabri .....	146
7.5.2	(SS) Synchronous and asynchronous interaction between the students .....	147
7.5.3	(AD) Ascending and descending processes between the spatio-graphical field and the theoretical field .....	148
7.6	SUMMARY .....	150
<b>CHAPTER 8. TELLING STORIES .....</b>		<b>152</b>
8.1	INTRODUCTION .....	152
8.2	THE STORY OF DEBORA AND GIULIA (D&G - CASE 2).....	155
8.2.1	Students' interactions and types of statements: using the mouse.....	157
8.2.2	Showing construction lines: a proof linked to the spatio-graphical field.....	161
8.2.3	Ascending/descending processes and emergent/planned interaction with Cabri: a change in focus.....	163
8.3	THE STORY OF ALESSANDRA AND TIZIANA (A&T - CASE 3) .....	167
8.3.1	Ascending/descending processes and emergent/planned interaction: a change in focus .....	168
8.4	THE STORY OF VALENTINA, MICHELA AND ELISA (V&M&E - CASE 4).....	173
8.4.1	Synchronous and asynchronous interactions together with ascending and descending processes: a rich proving process .....	174
8.4.2	<i>Lieu muet dragging</i> leading to a general conjecture .....	178
8.5	THE STORY OF ALICE AND WILL (A&W - CASE 5) .....	183
8.5.1	Showing and hiding construction lines: interactive feedback .....	184
8.5.2	<i>Lieu muet dragging</i> leading to a general conjecture .....	185
8.5.3	Types of statements in conjecturing and proving .....	190
8.6	THE STORY OF BARTOLOMEO AND TIZIANA (B&T - CASE 1) .....	195
8.6.1	Interacting <i>at</i> Cabri: synchronous and asynchronous interactions .....	195
8.6.2	Interacting <i>at</i> and <i>with</i> Cabri: asynchronous interaction and shifts between emergent and planned interaction.....	196
8.7	SUMMARY .....	199
<b>CHAPTER 9. PROVING AS A FOCUSING PROCESS .....</b>		<b>200</b>
9.1	INTRODUCTION .....	200
9.2	DEVELOPING AN EXPLANATORY FRAMEWORK. INTERSECTING STORIES: WHAT IS THE SAME AND WHAT IS DIFFERENT?.....	202
9.2.1	Dragging modalities: which, when and why? .....	202
9.2.2	Hiding or showing construction elements: a change in focus .....	207
9.2.3	Thinking sketches and proof sketches: searching for an alternative space to Cabri .....	211
9.2.4	Static and dynamic statements: focusing on relationships .....	213
9.2.5	Emergent and planned interaction with Cabri: what is taken on board? .....	216

9.2.6	Synchronous and asynchronous interactions between students: what kind of communication and understanding? .....	219
9.3	DEVELOPING AN EXPLANATORY FRAMEWORK. LINKING STORIES .....	222
9.3.1	Ascending and descending processes: constructing a bridge between the spatio-graphical field and the theoretical field .....	222
9.3.2	Cabri as a shared workspace .....	227
9.4	DEVELOPING AN EXPLANATORY FRAMEWORK. A NEW STORY: PROVING AS A <i>FOCUSING PROCESS</i> .....	231
9.4.1	Tools for focusing .....	234
9.5	SUMMARY .....	236
<b>CHAPTER 10. CONCLUSIONS AND IMPLICATIONS .....</b>		<b>238</b>
10.1	INTRODUCTION .....	238
10.2	THE PROVING PROCESS WITHIN A DYNAMIC GEOMETRY ENVIRONMENT .....	239
10.2.1	The <i>focusing process</i> as a process of instrumentalisation .....	241
10.3	IMPLICATIONS FOR TEACHERS .....	244
10.4	IMPLICATIONS FOR FURTHER RESEARCH .....	246
<b>REFERENCES .....</b>		<b>249</b>
<b>APPENDIX A. THE PROBLEMS FOR THE INTERVENTION STUDY IN THE ENGLISH</b>		
<b>SETTING .....</b>		<b>261</b>
A.1	SESSION 1. CONSTRUCTING AND DISCOVERING PARALLELOGRAMS .....	262
A.2	SESSION 2. ANGLE BISECTORS OF A QUADRILATERAL .....	262
A.3	SESSION 3. LOCUS PROBLEM .....	263
A.4	SESSION 4 AND 5. THE TREASURE HUNTING .....	264
A.5	SESSION 6. THE GAME OF PROVING .....	265
<b>APPENDIX B. THE PROBLEMS FOR THE INTERVENTION STUDY IN THE ITALIAN SETTING</b>		
<b>266</b>		
B.1	VARIGNON'S PROBLEM .....	266
B.2	PERPENDICULAR BISECTORS OF A QUADRILATERAL .....	267
<b>APPENDIX C. THE TRANSCRIPT OF BARTOLOMEO AND TIZIANA (B&amp;T -CASE 1) .....</b>		
<b>268</b>		
C.1	THE CONTEXT .....	268
C.2	THE TRANSCRIPT .....	269
C.2.1	Episode 1. Constructing the figure .....	269
C.2.2	Episode 2. Starting to explore. Formulating a conjecture about the parallelogram (C1) .....	271
C.2.3	Episode 3. Exploring the case of the point (C2) and the case of the trapezium (C3). .....	272
C.2.4	Episode 4. Proving the case of the parallelogram (C1-P1) .....	275
C.2.5	Episode 5. The case of the rhombus (C4) .....	280
C.2.6	Episode 6. Proving the case of the point inside (C2 & P2) .....	281
C.2.7	Episode 7. Exploring and proving the case of the right-angled trapezium (C5-P5) and the case of similar quadrilaterals (C8) .....	282

C.2.8	Episode 8. The case of the isosceles trapezium (C6) and the case of the rhombus (C4) .....	288
C.2.9	Episode 9. Formulating a general conjecture about cyclic quadrilaterals (C7).....	295
C.2.10	Episode 10. Concluding with a general conjecture (C9).....	297
<b>APPENDIX D. TABLE OF ANALYSIS FOR TWO EPISODES OF THE TRANSCRIPT OF BARTOLOMEO AND TIZIANA (CASE 1) .....</b>		<b>303</b>
<b>APPENDIX E. THE STORY OF DEBORA AND GIULIA (CASE 2) .....</b>		<b>312</b>
E.1	THE CONTEXT .....	312
E.2	THE PROVING PROCESS OF DEBORA AND GIULIA .....	313
E.2.1	Episode 1. Constructing the figure.....	313
E.2.2	Episode 2. Starting to explore. The case of the rhombus (C1) and the case of the point inside (C2).....	313
E.2.3	Episode 3. Towards a general conjecture (C4) .....	314
E.2.4	Episode 4. Exploring particular cases. The case of the rhombus (C1), the case of the square (C2), the case of the rectangle (C3), the case of the trapezium (C5) and the case of the parallelogram (C6).....	315
E.2.5	Episode 5. Starting to prove. The case of the square (C2) .....	316
E.2.6	Episode 6. Proving the case of the rhombus (C1).....	316
E.2.7	Episode 7. Trying to prove the case of the parallelogram (C6) .....	316
E.2.8	Episode 8. Trying to prove the case of the parallelogram (C6) again.....	317
E.3	SUMMARY OF CONJECTURES AND PROOFS .....	317
<b>APPENDIX F. THE STORY OF ALESSANDRA AND TIZIANA (CASE 3).....</b>		<b>319</b>
F.1	THE CONTEXT .....	319
F.2	THE PROVING PROCESS OF ALESSANDRA AND TIZIANA .....	320
F.2.1	Episode 1. Constructing the figure.....	320
F.2.2	Episode 2. Starting to explore. LMNP is a parallelogram (C1). LMNP rhombus (C2) and rectangle (C3). The case of the square (C4).....	320
F.2.3	Episode 3. Formulating conjectures. The case of the rectangle (C5), the case of the square (C4), the case of the parallelogram (C7), the case of the trapezium (C8).....	321
F.2.4	Episode 4. Starting to prove conjecture C8.....	322
F.2.5	Episode 5. Proving conjecture C4.....	322
F.2.6	Episode 6. Exploring again and verifying the proof P4: it's not a rhombus!.....	323
F.2.7	Episode 7. Trying to make sense of the proof P4 and the Cabri figure together.....	324
F.2.8	Episode 8. Constructing a square in Cabri .....	324
F.2.9	Episode 9. Going back to conjecture C4 and proof P4 .....	325
F.2.10	Episode 10. The case of the isosceles trapezium (C8) .....	325
F.3	SUMMARY OF CONJECTURES AND PROOFS .....	328
<b>APPENDIX G. THE STORY OF VALENTINA, MICHELA AND ELISA (CASE 4).....</b>		<b>330</b>
G.1	THE CONTEXT .....	330
G.2	THE PROVING PROCESS OF VALENTINA, MICHELA AND ELISA .....	330

G.2.1	Episode 1. Constructing the figure .....	330
G.2.2	Episode 2. Starting to explore the case of the square (C1) and the case of the parallelogram (C2).....	331
G.2.3	Episode 3. A'B'C'D' degenerating into a point: conjecturing (C4), checking and proving ....	332
G.2.4	Episode 4. Concave and convex quadrilaterals (C5) .....	333
G.2.5	Episode 5. The case of the rhombus (C6) and the isosceles trapezium (C7) .....	333
G.2.6	Episode 6. Proving C6 .....	334
G.2.7	Episode 7. Summary and new exploration - the case of the triangle outside (C8) and inside (C9).....	335
G.2.8	Episode 8. Summarising. The case of the right-angled trapezium (C10) and the case of the general trapezium (C11) .....	336
G.2.9	Episode 9. Proving the case of the rhombus (C6).....	337
G.3	SUMMARY OF CONJECTURES AND PROOFS .....	338
<b>APPENDIX H. THE STORY OF ALICE AND WILL (CASE 5).....</b>		<b>340</b>
H.1	THE CONTEXT.....	340
H.2	THE PROVING PROCESS OF ALICE AND WILL .....	341
H.2.1	Episode 1. Constructing the figure .....	341
H.2.2	Episode 2. Starting the exploration. The case of the point (C1) and the case of the parallelogram (C2).....	341
H.2.3	Episode 3. Guided exploration. The case of the rectangle (C3).....	342
H.2.4	Episode 4. New exploration and explaining conjecture C2 to the teacher.....	343
H.2.5	Episode 5. Writing down conjectures .....	343
H.2.6	Episode 6. Generation of the conjecture C5 .....	343
H.2.7	Episode 7. Starting to prove C5 .....	344
H.2.8	Episode 8. Explaining the proof P5 for C5 to the teacher.....	345
H.2.9	Episode 9. Writing down conjectures and proofs .....	345
H.2.10	Episode 10. A new proof: the case of the parallelogram (C2) .....	347
H.2.11	Episode 11. Presentations .....	348
H.3	SUMMARY OF CONJECTURES AND PROOFS .....	348
<b>LIST OF FIGURES.....</b>		<b>xi</b>
<b>LIST OF TABLES.....</b>		<b>xv</b>
<b>LIST OF EXTRACTS.....</b>		<b>xvi</b>

## LIST OF FIGURES

Figure 1.1. Overview of the research.....	8	Figure 6.13. B&T, Ep.9, #498 .....	112
Figure 2.1. Proof in mathematics and in school mathematics .....	19	Figure 6.14. B&T, Ep.10, #534 .....	112
Figure 2.2. Students' proof schemes (Harel & Sowder, 1996).....	35	Figure 6.15. B&T. Written work (1).....	113
Figure 2.3. Inference step in a deduction (Duval, 1996).....	36	Figure 6.16. B&T. Written work (2).....	114
Figure 3.1. Mediated act (Vygotsky, 1978) .....	47	Figure 6.17. B&T. Dragging modalities used throughout the proving process.....	118
Figure 3.2. The instrumental genesis (Verillion & Rabardel, 1995) .....	50	Figure 6.18. B&T. Dragging modalities used by each student throughout the process .....	119
Figure 3.3. What do students make out of this? (Goldenberg & Cuoco, 1998) .....	61	Figure 6.19. B&T, Ep.3, #99 .....	119
Figure 3.4. Moves between SG and T (Laborde, 1997).....	62	Figure 6.20. B&T, Ep.3, #69 .....	121
Figure 3.5. AP=PC=PB .....	67	Figure 6.21. B&T, Ep.3, #75 .....	121
Figure 3.6. AP=PC=CB .....	67	Figure 6.22. B&T, Ep.3, #78 .....	121
Figure 3.7. Wandering dragging .....	68	Figure 6.23. B&T. Hiding and showing construction lines. ....	123
Figure 3.8. Lieu muet dragging .....	68	Figure 6.24. B&T, Ep.3, #91 .....	123
Figure 3.9. Line dragging .....	68	Figure 6.25. B&T, Ep.8, #436 .....	124
Figure 3.10. Lieu muet becomes explicit.....	68	Figure 6.26. B&T, Ep.8, #441 .....	124
Figure 3.11. Linked dragging .....	68	Figure 6.27. B&T, Ep.2, #56 .....	127
Figure 3.12. Dragging test .....	68	Figure 6.28. B&T, Ep.2, #64 .....	128
Figure 5.1. A&W, Ep.3, #119.....	93	Figure 6.29. B&T, Ep.4, #135 .....	130
Figure 5.2. The analytical process .....	96	Figure 6.30. B&T. Key elements of the proving process .....	134
Figure 5.3. A preliminary analytical framework .....	101	Figure 7.1. The analytical framework.....	137
Figure 5.4. The research process .....	103	Figure 7.2. Type A categories .....	138
Figure 6.1. B&T. Perpendicular bisectors of a quadrilateral.....	105	Figure 7.3. B&T, Ep.8, #364 .....	139
Figure 6.2. B&T, Ep.1, #46 .....	106	Figure 7.4. B&T, Ep.3, #99 .....	139
Figure 6.3. B&T, Ep.2, #64 .....	107	Figure 7.5. A&W, Ep.5, #148.....	139
Figure 6.4. B&T, Ep.3, #69 .....	107	Figure 7.6. A&W, Ep.6, #173.....	139
Figure 6.5. B&T, Ep.3, #93 .....	107	Figure 7.7. Group 12, Session 8.....	140
Figure 6.6. B&T, Ep.3, #76 .....	108	Figure 7.8. B&T, Ep.3, #69 .....	141
Figure 6.7. B&T, Ep.3, #97 .....	108	Figure 7.9. B&T, Ep.3, #75 .....	141
Figure 6.8. B&T, Ep.4, #137 .....	108	Figure 7.10. B&T, Ep.3, #78 .....	141
Figure 6.9. B&T, Ep.6, #214 .....	110	Figure 7.11. B&T, Ep.4, #130 .....	142
Figure 6.10. B&T, Ep.7, #230 .....	110	Figure 7.12. B&T, Ep.2, #56 .....	142
Figure 6.11. B&T, Ep.8, #356 .....	111	Figure 7.13. B&T, Ep.3, #91 .....	143
Figure 6.12. B&T, Ep.8, #441 .....	111	Figure 7.14. B&T, Ep.8, #434 .....	143
		Figure 7.15. B&T, Ep.8, #441 .....	143
		Figure 7.16. Type B categories .....	144

Figure 7.17. Type C categories.....	146	Figure 8.38. A&W. Proof for C2 on OHP .....	194
Figure 7.18.....	149	Figure 8.39. B&T, Ep.8, #364 .....	197
Figure 7.19. The analytical categories .....	150	Figure 8.40. B&T, Ep.8, #376 .....	197
Figure 8.1. D&G. Perpendicular bisectors of a quadrilateral.....	156	Figure 9.1. Developing an explanatory framework .....	201
Figure 8.2. D&G, Ep.2, #111 .....	157	Figure 9.2. The analytical categories .....	202
Figure 8.3. D&G, Ep.2, #130 .....	160	Figure 9.3. Cross case analysis: use of dragging modalities .....	203
Figure 8.4. D&G, Ep.2, #133 .....	160	Figure 9.4. Cross case analysis: the use of guided dragging.....	205
Figure 8.5. D&G, Ep.2, #148 .....	160	Figure 9.5.....	209
Figure 8.6. D&G, Ep.2, #152 .....	160	Figure 9.6. Image of a square .....	210
Figure 8.7. D&G, Ep.3, #189 .....	161	Figure 9.7. B&T. Types of statements.....	214
Figure 8.8. D&G, Ep.3, #234 .....	161	Figure 9.8. A&W. Types of statements .....	215
Figure 8.9. D&G, Ep.3, #236 .....	162	Figure 9.9. Cross case analysis: types of statements .....	216
Figure 8.10. D&G, Ep.3, #442 .....	162	Figure 9.10. Ascending and descending processes .....	223
Figure 8.11. D&G, Ep.7, #542 .....	163	Figure 9.11. Development of dragging modalities .....	224
Figure 8.12. D&G, Ep.7, #545 .....	163	Figure 9.12. The proving process as a sequence of ascending and descending processes .....	227
Figure 8.13. A&T. Varignon's problem.....	167	Figure 9.13. Movements between internal and external contexts .....	228
Figure 8.14. A&T, Ep.2, #15.....	168	Figure 9.14. Two different internal contexts are projected onto the external context.....	230
Figure 8.15. A&T, Ep.2, #20.....	168	Figure 9.15. The internal contexts communicate through the external context. ....	230
Figure 8.16. A&T, Ep.5, #178.....	169	Figure 9.16. The focusing process as a combination of ascending-descending processes between the spatio-graphical field and the theoretical field and interactions between the internal and external context.....	233
Figure 8.17. A&T, Ep.6, #211 .....	170	Figure A.1. Angle bisectors of a quadrilateral. ....	263
Figure 8.18. V&M&E, Ep.2, #66 .....	174	Figure A.2. The treasure hunting .....	264
Figure 8.19. V&M&E, Ep.2, #68 .....	174	Figure A.3. The game of proving .....	265
Figure 8.20. V&M&E, Ep.2, #69 .....	175	Figure B.1. Varignon's problem.....	267
Figure 8.21. V&M&E, Ep.2, #71 .....	175	Figure B.2. Perpendicular bisectors of a quadrilateral.....	267
Figure 8.22. V&M&E, Ep.2, #82 .....	177	Figure C.1. B&T. Perpendicular bisectors of a quadrilateral.....	268
Figure 8.23. V&M&E, Ep.2, #87 .....	177	Figure C.2.....	269
Figure 8.24. V&M&E, Ep.3, #113 .....	179	FigureC.3.....	269
Figure 8.25. V&M&E, Ep.3, #140 .....	180	FigureC.4.....	270
Figure 8.26. A&W. Angle bisectors of a quadrilateral.....	183	FigureC.5.....	270
Figure 8.27. A&W, Ep.1, #5.....	184	FigureC.6.....	271
Figure 8.28. A&W, Ep.4, #99.....	184		
Figure 8.29. A&W, Ep.5, #148.....	186		
Figure 8.30. A&W, Ep.6, #173.....	186		
Figure 8.31. A&W, Ep.6, #185.....	186		
Figure 8.32. A&W, Ep.6, #199.....	186		
Figure 8.33. A&W. Paper sketches. ....	189		
Figure 8.34. A&W, Ep.2, #36.....	190		
Figure 8.35. A&W, Ep.2, #38.....	190		
Figure 8.36. A&W, Ep.4, #127.....	191		
Figure 8.37. A&W, Ep.11, #404.....	193		

FigureC.7 .....	272	FigureC.48 .....	296
FigureC.8 .....	272	FigureC.49 .....	297
FigureC.9 .....	272	FigureC.50 .....	298
FigureC.10 .....	273	FigureC.51 .....	298
FigureC.11 .....	273	FigureC.52 .....	298
FigureC.12 .....	273	FigureC.53 .....	299
FigureC.13 .....	274	FigureC.54 .....	300
FigureC.14 .....	274	Figure E.1. D&G. Perpendicular bisectors of a quadrilateral .....	312
FigureC.15 .....	274	Figure E.2. D&G, Ep.1, #83 .....	313
FigureC.16 .....	275	Figure E.3. D&G, Ep.2, #112 .....	314
FigureC.17 .....	275	Figure E.4. D&G, Ep.2, #130 .....	314
FigureC.18 .....	276	Figure E.5. D&G, Ep.2, #152 .....	314
FigureC.19 .....	276	Figure E.6. D&G, Ep.3, #157 .....	315
FigureC.20 .....	276	Figure E.7. D&G, Ep.3, #206 .....	315
FigureC.21 .....	277	Figure E.8. D&G, Ep.4, #236 .....	315
FigureC.22 .....	277	Figure E.9. D&G, Ep.4, #286 .....	316
FigureC.23 .....	279	Figure E.10. D&G, Ep.6, #438 .....	316
FigureC.24 .....	281	Figure F.1. A&T. Varignon's problem .....	319
FigureC.25 .....	281	Figure F.2. A&T, Ep.1, #11 .....	320
FigureC.26 .....	283	Figure F.3. A&T, Ep.2, #39 .....	321
FigureC.27 .....	283	Figure F.4. A&T, EP.3, #77 .....	321
FigureC.28 .....	283	Figure F.5. A&T, Ep.3, 109 .....	322
FigureC.29 .....	284	Figure F.6. A&T, Ep.4, #123 .....	322
FigureC.30 .....	285	Figure F.7. A&T, Ep.5, #178 .....	323
FigureC.31 .....	287	Figure F.8. A&T, Ep.6, #208 .....	323
FigureC.32 .....	288	Figure F.9. A&T, Ep.6, 231 .....	323
FigureC.33 .....	289	Figure F.10. A&T, Ep.8, #298 .....	325
FigureC.34 .....	289	Figure F.11. A&T, Ep.8, #313 .....	325
FigureC.35 .....	289	Figure F.12. A&T, Ep.10, #342 .....	325
FigureC.36 .....	290	Figure F.13. A&T. Written work (1) .....	326
FigureC.37 .....	290	Figure F.14. A&T. Written work (2) .....	327
FigureC.38 .....	291	Figure G.1. V&M&E, Ep.1, #37 .....	331
FigureC.39 .....	291	Figure G.2. V&M&E, Ep.2, #82 .....	332
FigureC.40 .....	292	Figure G.3. V&M&E, Ep.3, #113 .....	332
FigureC.41 .....	292	Figure G.4. V&M&E, Ep.4, #200 .....	333
FigureC.42 .....	292	Figure G.5. V&M&E, Ep.5, #257 .....	334
FigureC.43 .....	293	Figure G.6. ....	335
FigureC.44 .....	293	Figure G.7 .....	335
FigureC.45 .....	293	Figure G.8 .....	335
FigureC.46 .....	294	Figure G.9. V&M&E, Ep.7, #403 .....	335
FigureC.47 .....	296		



Figure G.10. V&M&E, Ep.7, #448 .....	335	Figure H.6. A&W, Ep.6, #173.....	344
Figure G.11. V&M&E, Ep.8, #541 .....	336	Figure H.7. A&W, Ep.6, #185.....	344
Figure G.12. V&M&E, Ep.8, #559 .....	337	Figure H.8. A&W, Ep.6, #199.....	344
Figure G.13. V&M&E, Ep.9, #564 .....	337	Figure H.9. A&W, figure for the proof.....	345
Figure H.1. A&W. Angle bisectors of a quadrilateral.....	340	Figure H.10. A&W. Alice's sketches on paper while constructing the proof for conjecture C5.	346
Figure H.2. A&W, Ep.1, #5.....	341	Figure H.11. A&W. OHP the students presented to the whole class for conjecture C5 and proof P5 .....	347
Figure H.3. A&W, Ep.2, #45.....	342	Figure H.12. A&W. OHP the students presented for the conjecture C2 and proof P2.....	348
Figure H.4. A&W, Ep.4, #99.....	343		
Figure H.5. A&W, Ep.5, #148.....	343		

## LIST OF TABLES

Table 2.1. The three revolutions in the notion of proof .....	15	Table 8.1. The case studies selected for the analysis .....	153
Table 4.1. The students involved in the English setting .....	72	Table 8.2. Conjectures and proofs for B&T, D&G and V&M&E .....	153
Table 4.2. The students involved in the Italian setting .....	75	Table 8.3. Conjectures and proofs for A&W ...	154
Table 5.1. The students involved in the research	85	Table 8.4. Conjectures and proofs for A&T ....	154
Table 5.2. Collecting data .....	88	Table 8.5. The analytical categories .....	154
Table 5.3. Data collected from the English setting .....	88	Table 8.6. Analysis of the case studies .....	155
Table 5.4. Data collected from the Italian setting .....	88	Table 8.7. Comparison of extracts .....	199
Table 5.5. The corpus of data for the analysis ...	91	Table 9.1. Film/photo dragging and ascending/descending processes .....	207
Table 5.6. Example of the layout of a transcript	93	Table 9.2. Cross case analysis: the use of construction elements .....	207
Table 5.7. Example of a table of analysis .....	94	Table 9.3. Cross case analysis: the use of sketches .....	211
Table 5.8. Dragging modalities.....	98	Table 9.4. Cross case analysis: emergent and planned interaction.....	217
Table 6.1. B&T. Conjectures and proofs .....	115	Table A.1. The intervention in the English setting .....	261
Table 6.2. B&T. Evolution of conjectures and proofs .....	116	Table A.2. The classroom-based sessions in the English setting .....	262
Table 6.3. Dragging modalities.....	117	Table B.1. The classroom-based sessions in the Italian setting .....	266
Table 6.4. B&T. Types of statements .....	125	Table E.1. D&G. Conjectures and proofs .....	317
Table 7.1. Dragging modalities (DM).....	140	Table E.2. D&G. Evolution of conjectures and proofs .....	318
Table 7.2. Film-dragging and Photo-dragging.	141	Table F.1. A&T. Conjectures and proofs.....	328
Table 7.3. Hiding and showing construction elements (C).....	142	Table F.2. A&T. Evolution of conjectures and proofs .....	329
Table 7.4. Thinking and proof sketches (SK) ..	143	Table G.1. V&M&E. Conjectures and proofs .	338
Table 7.5. Types of statements (ST) .....	145	Table G.2. V&M&E. Evolution of conjectures and proofs .....	339
Table 7.6. Emergent and planned interaction with Cabri (SC).....	147	Table H.1. A&W. Conjectures and proofs.....	349
Table 7.7. Synchronous and asynchronous interactions between students (SS) .....	148	Table H.2. A&W. Evolution of conjectures and proofs .....	350
Table 7.8. Ascending and descending processes between the spatio-graphical field and the theoretical field (AD).....	149		

---

## LIST OF EXTRACTS

Extract 6.1. B&T, Ep.3, #97-100.....	119	Extract 8.7. A&T, Ep.5, #178-198.....	169
Extract 6.2. B&T, Ep.3, #80-82.....	120	Extract 8.8. A&T, Ep.6, #208-227.....	170
Extract 6.3. B&T, Ep.3, #69-79.....	121	Extract 8.9. A&T, Ep.7, #251-264.....	171
Extract 6.4. B&T, Ep.2, #55.....	121	Extract 8.10. V&M&E, Ep.2, #66-73.....	175
Extract 6.5. B&T, Ep.6, #233.....	122	Extract 8.11. V&M&E, Ep.2, #74-93.....	177
Extract 6.6. B&T, Ep.5, #198-199.....	122	Extract 8.12. V&M&E, Ep.3, #113-127.....	179
Extract 6.7. B&T, Ep.4, #175-176 & #192-193.....	122	Extract 8.13. V&M&E, Ep.3, #138-173.....	181
Extract 6.8. B&T, Ep.3, #91-93.....	123	Extract 8.14. A&W, Ep.2, #15-20.....	185
Extract 6.9. B&T, Ep.8, #434-441.....	124	Extract 8.15. A&W, Ep.4, #99-101.....	185
Extract 6.10. B&T, Ep.2, #49-68.....	128	Extract 8.16. A&W, Ep.7, #168-201.....	186
Extract 6.11. B&T, Ep.4, #138-199.....	130	Extract 8.17. A&W, Ep.9, #340-367.....	189
Extract 8.1. D&G, Ep.2, #84-122.....	157	Extract 8.18. A&W, Ep.2, #36-45.....	190
Extract 8.2. D&G, Ep.2, #123-153.....	160	Extract 8.19. A&W, Ep.4, #127-138.....	191
Extract 8.3. D&G, Ep.3, #189-192, #234-236, #442.....	162	Extract 8.20. A&W, Ep.6, #143-146.....	192
Extract 8.4. D&G, Ep.7, #542-566.....	164	Extract 8.21. A&W, Ep.11, #399-411.....	193
Extract 8.5. D&G, Ep.7, #571-589.....	165	Extract 8.22. B&T, Ep.8, #364-376.....	197
Extract 8.6. A&T, Ep.2, #16-42.....	168		

## CHAPTER 1. INTRODUCTION

*One of the most remarkable gifts human civilization has inherited  
from ancient Greece is the notion of mathematical proof.*

*(Babai, 1992)*

*Dynamic geometry should not be treated as if it is merely a new interface to Euclidean construction. Line  
segments that stretch and points that move relative to each other are not trivially the same objects  
that one treats in the familiar synthetic geometry, and this suggests new styles of reasoning.*

*(Goldenberg, 1995)*

### 1.1 SETTING THE PROBLEM

The overall aim of this research is to analyse learning environments in which students can be supported in their approach to proving in school mathematics, and more generally to theoretical thinking in mathematics. In particular, the potentialities of a dynamic geometry software, namely Cabri-Géomètre (Baulac, Bellemain & Laborde, 1988), will be investigated with respect to this problem.

The problem of the teaching and learning of proof in school has been an object of investigation in the mathematics education and mathematicians community for some years now. Current research shows that this problem needs to be tackled from different perspectives, that are deeply interrelated and can be distinguished only for analytical purposes: historical, concerning the evolution of the notion of proof over time (see Barbin, 1988); epistemological, with regards to the status of mathematical objects, properties and relations involved in the teaching and learning of proof (see Balacheff, 1999; Lolli, 1999; Rav, 1999); cognitive, concerning students' cognitive processes when constructing proofs (see Duval, 1991; Chazan, 1993; Duval, 1996; Hanna, 1996; Harel & Sowder, 1996;

---

Mariotti, Bartolini Bussi, Boero, Ferri & Garuti, 1997; Arzarello, Micheletti, Olivero, Paola & Robutti, 1998b); didactical, with respect to the classroom practice and to the role of the teacher in the process of teaching and learning proof (see Arsac, 1992; Bartolini Bussi & Mariotti, 1998). Considerations about school curricula are also to be taken into account to ground the research in practice (see Hanna, 1995; Hoyles, 1997; Boero, 2000). In some countries proof has been reduced in importance or eliminated from the mathematics curriculum (Hanna, 2000); for example in the UK, proof had become inaccessible to the majority, in that it was only at Level 7 or 8 of AT1<sup>1</sup>, when students were expected to prove their conjectures in any formal sense (Hoyles, 1997). However, the Report on the Teaching and Learning of Geometry 2001 (<http://www.royalsoc.ac.uk/templates/statements/index.cfm>) re-establishes the importance of including proof in the curriculum. In other countries, proof has been largely reintroduced in the curriculum since elementary school levels (e.g. see the NCTM Standard 2000, <http://standards.nctm.org/>). On the contrary in Italy, proof has always been a core element of the mathematics curriculum of the Liceo<sup>2</sup>.

Given the current availability of a range of new technologies, it may be important to take into consideration their potentialities with respect to the teaching and learning of proof. In the first place, mathematics education research has been investigating what is the impact of technological tools in the classroom (e.g. Schwartz & Yerushalmy, 1992; Laborde, 1993; Hanna, 1996; Artigue, 1997; Bartolini Bussi & Mariotti, 1998; Sutherland & Balacheff, 1999; Lagrange, Artigue, Laborde & Trouche, 2001). Aspects of the interaction of pupils with the technological environments used are also important in order to provide information about the changes new technologies bring about in the classroom context. Understanding how and why new technologies may be useful in the classroom with respect to the context of proof is a crucial issue. A strand of research has studied specifically the impact of dynamic geometry software with respect to proving in geometry (e.g. Goldenberg, 1995; Arzarello, Gallino, Micheletti, Olivero, Paola & Robutti, 1998a; Laborde, 1998; Mariotti, 1998).

Results from historical and epistemological analyses show that proof is a crucial activity within mathematical practice (Balacheff, 1999; Rav, 1999; Arzarello, 2000), as will be discussed later in the thesis. Given the fact that the opportunity of teaching proof in school

---

<sup>1</sup> AT1 is Attainment Target 1 of the National Curriculum. Children aged 11-14 years should be within the range of Levels 3 to 7. Level 8 is available for very able pupils.

<sup>2</sup> Liceo is a type of secondary school with a classical (Liceo Classico) or scientific orientation (Liceo Scientifico).

is established, what does teaching proof in the classroom mean? Answering this question requires the problem to be analysed from a cognitive and didactical perspective.

This study will provide a cognitive analysis of the problem. In particular it will be concerned with the analysis of:

- students' problem solving processes in a dynamic geometry environment in the context of open problems in geometry;
- the interactions taking place between the students and the tools used (mainly dynamic geometry software) and between the students themselves.

The outcomes of the study will add to the body of knowledge about the teaching and learning of proof and will identify some potential aspects regarding the use of new technologies in the classroom context.

## 1.2 BACKGROUND OF THE AUTHOR

This section provides an account of my background with regards to when and how I approached mathematics education research. My personal background has undoubtedly influenced the present study.

### 1.2.1 School experience

I never had any problems in mathematics when I was at primary and secondary school. I always had good marks, the best marks. However, I am not sure that I was really doing mathematics. In the first two years of secondary school (14-15 years old), the teacher used to do a lot of geometry. At the beginning we had to learn many theorems and proofs which she gave us. From this practice we were supposed to learn how to do proofs by ourselves, a thing we rarely did. Being given a task in the form 'prove that ...' was always quite scaring and no one ever appreciated why we were doing such things. In the subsequent three years (16-19), my mathematics teacher used to teach us about many formulae and procedures. We never had the pleasure of knowing *why* a certain formula existed, nor *where* it came from. During the lessons we used to do many exercises at the blackboard. We were supposed to learn the 'theory', by ourselves, through the repetition of standard exercises. The only important thing was to become able to solve exercises in order to get a good mark for coursework, no matter if we did not know exactly what we were doing. By the middle of the first year many students just gave up and stopped studying mathematics, since they could see no point in doing such a useless thing.

---

### 1.2.2 Experience with mathematics education

At the end of high school I had no idea about what kind of subject to choose at university. I liked everything, so I took a long time before making up my mind. I decided to do mathematics, let us say by chance.

When I started university<sup>3</sup>, in Italy, in most courses teachers stood at the front of the class giving lectures and the students took notes. You had mainly to work on your own in order to understand the subject. In most examinations you were required to repeat definitions, theorems and proofs learnt by heart. At the end of my second year I was really annoyed with the way we were taught and I began to think that mathematics should be something different. This is one of the reasons why I decided to study didactics of mathematics from the third year onwards. I took the course ‘Elementary Mathematics from an Advanced Standpoint’, and my eyes were opened. We studied Brousseau and the theory of didactic situations, Piaget and Vygotsky. We were *doing* things, for instance problem situations; we were really *doing mathematics*. Most of the students did not like it because they were used to being passive in lectures, while here we were required to interact with the teacher and with each other and work hard in constructing and solving problem situations. I was really struck by this way of teaching and I thought: this is the way I would teach if I were in a classroom. I was struggling all the time with my friends who believed that it was too unrealistic, but I felt very engaged in this thing so that I was thinking of a ‘revolution’ in the usual way of teaching, especially in secondary schools. Teachers have the power to structure children’s image of mathematics; I wanted to try to change the common image people have.

During the fourth year I attended a course focused on new software used in mathematics education (Cabri, Derive, Maple, Excel). I found this issue to be so important that I decided to do the dissertation for my undergraduate degree in this field. During this period I worked within a Didactic Research Group at the University of Turin for about one year. This group is made up of researchers operating in the Department of Mathematics, mathematics secondary school teachers and university students doing their degree dissertation<sup>4</sup>. It aims to

---

<sup>3</sup> I started university in 1993. The situation has slightly improved since then and some changes to teaching methods have taken place.

<sup>4</sup> In Italy all degree courses require a final piece of work before graduation to be written up as a thesis. The thesis can be in any mathematics field. Typical works to be carried out as a thesis for students who want to work in the mathematics education area consist of short or long term projects in the classroom, linked to the teachers who belong to the Didactic Research Groups within the university. Therefore the students who are carrying out their dissertation take part within these groups as active members, planning and discussing their experiences in the classroom.

renew the contents and methods of teaching, starting from the requirements and difficulties pointed out by the teachers themselves through systematic and joint comparisons.

The presence of mixed research groups has characterised Italian mathematics education research since the 70s. The existence of mixed research groups (in which both teachers from schools and researchers from universities were working together) allowed an increasing integration of the two components, so that a separation between theoretical research and action-research, which took place in other European countries (e.g. France and Germany, see Griesel & Steiner, 1992; Rouchier, 1994), was avoided in Italy. The current tradition of mathematics education research is referred to as 'research for innovation' (Arzarello & Bartolini Bussi, 1998). The object of study is the teaching and learning of mathematics, both in specific classroom contexts and in relation to the more general educational context. The research aims are: to develop paradigmatic examples concerning improvement in the teaching of mathematics (e.g. partial or global curricula innovations); to study the conditions for their implementation in the classroom and the factors which may be an obstacle to this; to develop innovative theoretical models, which may be used by teachers to guide their action in the classroom; to develop innovative methodologies of working in the classroom.

The impact on the educational system of this research concerns: dissemination of the projects for curricular innovation to big groups of teachers (following the tradition of the NdRD<sup>5</sup>); discussion of the complex classroom processes with teachers in INSET courses, in order to make them aware of their important role in the classroom; dissemination of methodological innovations, which are suggested by the research methodology itself.

Research for innovation is characterised by experimental features to be integrated with theoretical aspects. The main aim is innovation as research and not only innovation as action in the classroom. Teachers are actively involved in all the phases of research: the method of participant observation (Brown & Dowling, 1998) is the most commonly used to collect and interpret data. Typical outcomes from this kind of research are for example projects for global or local innovations in the curricula (e.g. with respect to contents or teaching methods) and models for classroom processes (e.g. the role of the teachers). These products are usually framed by a theoretical framework, which is a result of the research itself. Consequently, not only concrete products (linked to concrete contexts) are developed, but also general results.

The subject we discussed in the Didactic Research Group was 'proof in mathematics'; to be more precise, we tackled the delicate transition from exploring geometric situations and formulating conjectures to proving them more formally, reflecting on the possible use of new technological tools, Cabri in particular, as mediators. The discussions within the group together with theoretical studies on the subject gave birth to the setting-up of an innovative project of teaching geometry in the first two years of secondary school. The planning and implementation of this project in two classrooms was part of my dissertation for my Mathematics degree. I really enjoyed doing this little piece of research and when I finished my degree I thought about carrying on doing research in mathematics education. I presented part of the results we observed in the classroom at the PME22 Conference (Arzarello et al., 1998a; 1998b). This allowed me to come into contact with the mathematics education community and reinforced my intention.

---

<sup>5</sup> Nuclei di Ricerca Didattica (i.e. Groups for Research in Education). They were created in the 70s (see Malara, 1998). One of the best known mathematicians who had a fundamental role in the creation of the NdRD is Giovanni Prodi (see Prodi, 1975/1977).



---

This is where I was when I started the 'PhD journey'. The general problem which I was interested in was the teaching and learning of proof in geometry and the role of new technologies within this process, both from the point of view of the teacher and of the students.

### **1.3 AIMS AND RESEARCH QUESTIONS**

Since proof is a crucial aspect of mathematics, despite all the difficulties that students have in approaching proof, as identified in the literature, they should have the opportunities to engage with this mathematical experience. Therefore ways of supporting students in their approach to proving should be investigated. If new technologies change how knowledge is constructed, acting as conceptual reorganisers, investigating how the experience of proving takes place within a dynamic geometry environment may provide useful elements to explain why and how this tool can be a support for proving activities.

The research consisted of two studies, which took place in secondary school classrooms (15-17 years old pupils). The context is that of open problems in geometry<sup>6</sup> within a dynamic geometry environment, namely Cabri-Géomètre. The overall aim of the project is to investigate the processes involved in constructing conjectures and proofs in geometry, when interacting with a dynamic geometry environment, with a particular focus on the interplay between the spatio-graphical field (including Cabri objects, paper drawings, etc) and the theoretical field (including geometrical properties, theorems and definitions) (Laborde, 1998). In particular, my focus is on two kinds of transformations that the proving process involves: transformations on objects and transformations on statements. The transformations on objects involve manipulations of objects in the Cabri environment, for example via dragging, or on paper. The transformations on statements refer to the shifts from facts and experiences in a precise space and time to de-timed logical statements of the form 'if ...then'. These statements have a different epistemological status, and the shifts are essential in the context of an approach to theoretical thinking. Particular attention is paid to the role played by a dynamic geometry environment and its characterising features and to the interactions occurring between students when using this tool and between students and the tool itself. The elaborated framework will show which elements may support students' production of conjectures and proofs, on the basis of observations of students developing different ways of approaching proving.

Given this background, the particular aims of the project are:

**To investigate the development of the proving process (i.e. the construction of conjectures and proofs) within a dynamic geometry environment.**

Particular attention will be paid to the interplay of spatio-graphical and theoretical elements (Laborde, 1998) towards the formulation of general statements and to the way students manage this interplay and to the impact Cabri has on this. Questions asked will include:

- What are the key elements in the development of the proving process?
- How do students interpret and use the geometrical objects and relationships experienced through a dynamic geometry software?

**To investigate the interactions taking place in the proving process.**

In order to study the role technological tools have in the proving process, it is important to take into account students' interactions with the environment, as well as student-student interactions in the presence of the tool. The interaction with Cabri takes place through a number of practices, such as constructing, dragging, measuring, calculating etc. Particular attention will be paid in this study to the role of the dragging function and of construction elements in Cabri. Moreover, other tools used as a support in the proving process, as for example sketches on paper, will be studied. Questions asked will include:

- What kind of communication can be established between the students working with the computer?
- What kind of interaction takes place between the students and Cabri?

Figure 1.1 presents an overview of the research.

---

<sup>6</sup> Geometry was chosen as the mathematical context because of the pivotal historical and cultural role has had with respect to proving.

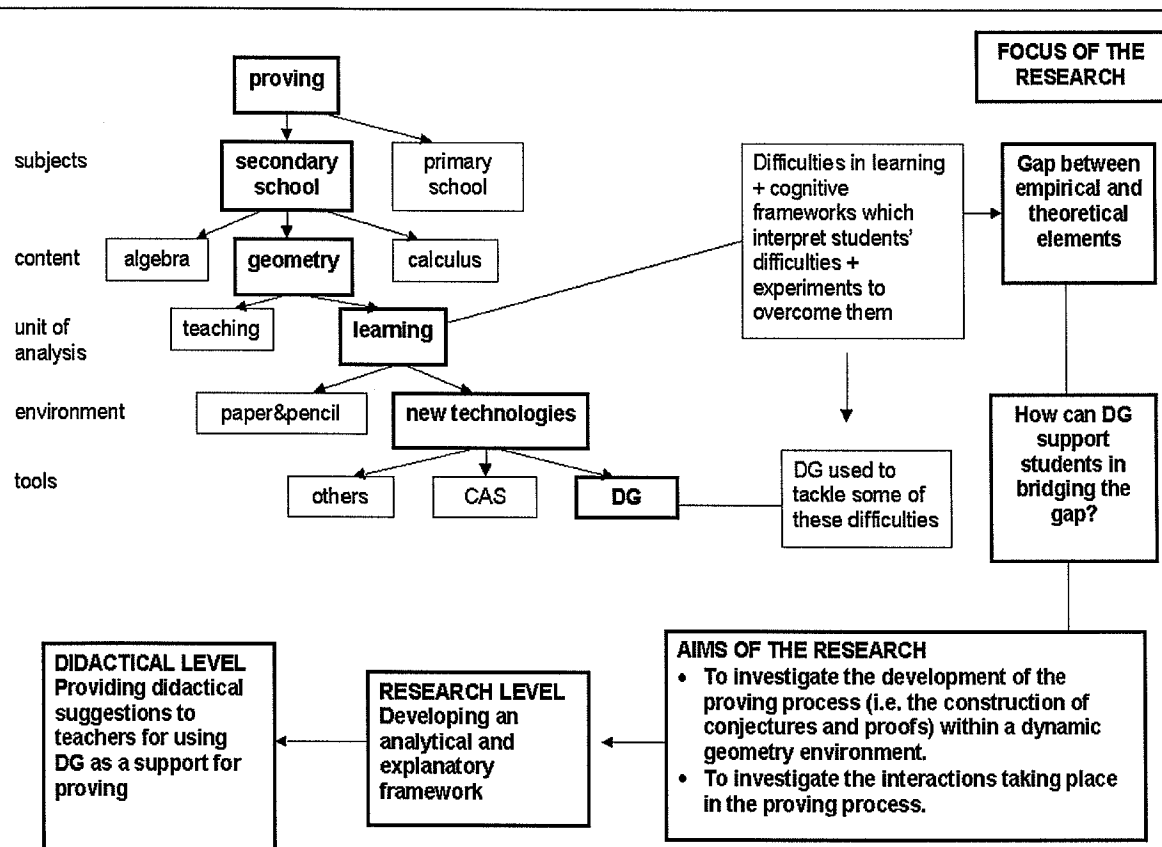

Figure 1.1. Overview of the research

## 1.4 OVERVIEW OF THE STUDY

There are ten chapters in the dissertation. This chapter has set the scene of the research. The following two chapters will provide a review of the theoretical background from which the project draws. Chapters four and five tackle methodological issues. Discussion of the main study (including the development of an analytical and explanatory framework) is then developed in chapters six to nine. Conclusions and implications are presented in chapter ten.

Chapter one sets the scene of this research. First a brief outline of the researcher's background is given, with respect to the encounter with mathematics education research. Second, the aims of the project are stated. Finally an overview of the whole thesis is outlined.

Chapter two provides a literature review of the current research on proof, taking into account the different viewpoints: epistemological, cognitive and didactical. The perspective on proof taken on board by this research study is presented and the proving process defined.

Chapter three reviews theoretical perspectives on the use of new technologies in mathematics education and then focuses on the variety of studies on the use of dynamic

geometry software, with particular respect to its relation to proving. A cognitive model related to the use of dragging in Cabri, previously elaborated on the basis of classroom observations, is presented.

Chapter four sets out the teaching and learning context in which the main study took place.

Chapter five defines the methodology of the main study, which consisted of two intervention studies in two settings, one in England and one in Italy, and elaborates the reasons for the choice of particular research methods in relation to the aims and the theory.

Chapter six presents a detailed analysis of one case study, which singles out key elements in the proving process. The analysis provides the ground for the development of the analytical framework.

Chapter seven lays out the analytical framework to be used to analyse the data from the two intervention studies. The categories chosen are described in detail. Questions are raised to guide the analysis.

Chapter eight presents the analysis of extracts from all data collected in the study according to the analytical framework previously developed.

Chapter nine provides a comparison of the issues and trends emerging from the data and elaborates an explanatory framework which brings together all issues which emerged from the cross case analysis.

Chapter ten draws the final conclusions from the project, implications for teachers and issues for further research.

---

## CHAPTER 2. PROOF AND PROVING: A DEBATE

*That's what's wrong with arithmetic, that's why I hate it and it shouldn't exist: there's no why. In history and spelling and all that stuff you can always ask why, WHY did George Washington start fighting England, you ask them and they tell you. [...] But in arithmetic, I said, taking a huge breath, you can't ask why, you just have to believe them when they tell you stuff, they get mad when you ask, they're telling you this is how you add, and you say well, why is that number on the bottom, and then Mrs Plank looks at you like she wants you DEAD, NOW.*

*(T. McEwen, Arithmetic, 1999)*

### 2.1 INTRODUCTION

In recent years some crucial aspects of mathematics have been reduced in importance, or even removed from the basic requirements of secondary school in some countries (Boero, 2000). Proof is one of these. Understanding why this happened is crucial for developing the basis of a project focused on the teaching and learning of proof. This issue has been, and currently is, addressed both at a school level and at a research level by mathematicians, mathematics educators and teachers all over the world, as emerges from the publications in the major Mathematics Education journals and from the presentations at Mathematics Education conferences (e.g. PME, CIEAEM).

Different perspectives have been investigated. The current debate concerns three aspects: historical-epistemological, cognitive and didactical, which can be distinguished only for analytical purposes, as all of them are to be taken into account in any research on proof. Historical and epistemological studies concern the evolution of the notion of proof over time (see e.g. Barbin, 1988; Arsac, 1999b) and the status of mathematical objects, properties and relations involved in the teaching and learning of proof (see e.g. Balacheff,

1987; Thurston, 1995; Hanna, 1996; Lolli, 1999; Rav, 1999); cognitive research concerns students' cognitive processes when constructing or understanding proofs (see e.g. Duval, 1991; Harel & Sowder, 1996; Garuti, Boero, & Lemut, 1998; Bartolini Bussi, 2000; Healy, 2000a; 2000b; Maher & Kiczek, 2000; Simon, 2000; Küchemann & Hoyles, 2001); didactical studies concern the role of proof in the mathematics curriculum (see e.g. Hanna, 2000; Knuth, 2000) and possible ways of working with proof in the teaching and learning context (see e.g. Hoyles, 1998; Sekigushi, 2000).

The main issues being tackled across all studies are:

- the definition of roles and functions of proof in different historical and institutional settings;
- the function proof should have in mathematics and in school mathematics;
- the relationship between different activities involved in proving;
- the ways to support students in their approach to proving in the classroom.

This chapter is divided into five main sections, which reflect the current debate and provide the basis for the particular perspective on proof shared in this study. The first section deals with epistemological perspectives on proof, providing a brief historical overview of the dynamic evolution of this concept and of the relationship between exploring, conjecturing and proving. In the second section the role of proof in the mathematics curriculum is discussed. In the third section perspectives on the teaching and learning of proof in the classroom are outlined. In section four cognitive theoretical frameworks and teaching experiments are presented. Finally the perspective on proof shared by this study, i.e. the concept of the proving process, is developed.

## **2.2 DEFINING THE ROLE AND FUNCTION OF PROOF**

Why proving? What does proving mean? What is the meaning of proof? All these questions should be asked prior to any engagement with the teaching and learning of proof. History of mathematics may be a means of grasping the meanings and functions of mathematical objects: which problems were at the basis of their construction and successive evolutions? This section provides an historical account of the different definitions and roles of proof which have been established over the years. At the end the relationships between different activities related to proving (i.e. experimenting and conjecturing) will be explored.

---

### 2.2.1 The three revolutions

What is a proof? What functions does proof have? How is something established to be a proof? Traditionally, the function of proof in mathematics and school mathematics has been seen almost exclusively in terms of convincing with respect to the correctness of a mathematical statement (deVilliers, 1990; Thurston, 1995; Harel, 1998; Rav, 1999). However, the notion of convincing is ambiguous. Convincing may involve both theoretical aspects and psychological aspects, and be directed internally or externally, according to who is to be convinced: oneself, a friend or an enemy (Mason, Burton, & Stacey, 1985, p.95). Harel & Sowder (1996) define the "proving process" as the process used by a person to eliminate or raise doubts about the validity of an observation, being then convinced about either its validity or falsity. This is made up of two sub-processes: ascertaining, that is the process used by an individual to eliminate his/her doubts about the validity of an observation (directed internally); persuading, that is the process used by an individual to eliminate other people's doubts about the validity of an observation (directed externally). Barbin (1988) argues that there have been three main revolutions regarding the role of proof over the centuries: Euclid, Descartes and Hilbert are considered milestones in the historical and epistemological development of the notion of proof. The three revolutions can be seen in terms of different aspects of convincing, which may be directed internally (convincing oneself) or externally (convincing a friend or an enemy).

In the 6<sup>th</sup> century BC in Greece the basis for the society Plato describes in his dialogues was set: democracy was born. All the matters concerning cities needed to be discussed in public. While in the Egyptian civilisation the power belonged to writing, which was a privilege of the scribes, the Greek society privileged speaking: the aim of any political and social discourse was to convince people by means of arguments based on the *logos*. This climate affected also the intellectual life, so that this was the context in which proving activities were first carried out, something which did not appear in Egyptian or Babylonian mathematics. Proving was born as a social act aimed at **convincing the listener** (Barbin, 1988). The first step consisted of admitting the existence of some initial points, which in Euclid's *Elements* are named postulates; these are self evident and as such are considered to be true. Proofs for Euclid are chains of propositions derived deductively from initial propositions about primitive objects (postulates). Since the postulates are true, also the other derived propositions are true: truth is maintained thanks to logical principles. **Deductive reasoning** was the way to make the interlocutor agree with the claim that was made. Euclid's proofs clearly reveal that their aim was convincing of the certainty of a

claim in a theoretical way (i.e. with deductive reasoning) and trying to avoid any consideration which may be used against the claim<sup>1</sup>.

The 17<sup>th</sup> century marked a deep rupture in terms of the notion of proof: the mathematicians of that time admired the ancient mathematicians' proofs but at the same time criticised their proving processes, arguing that they had never been clear about how they constructed

<sup>1</sup> In fact, in Euclid there are many proofs by contradiction and there is no description of how proofs are constructed. For example, Euclid provided an algebraic proof by contradiction of the incommensurability of the side and diagonal of a square. Euclid's proof by contradiction is the following. If AB and BD are commensurable, then AB and BD are respectively n times and m times a common number. By Pythagoras' theorem  $BD^2 = 2AB^2$ , so  $m^2 = 2n^2$ . We can assume that m and n are co-prime and so  $m \neq 1$ . Since  $m^2$  is even, then m is even too and n is odd. If we set  $m = 2k$ , then  $n^2 = 2k^2$ , which implies that  $n^2$  is even, and so n is even too. A number cannot be both even and odd at the same time, therefore there is a contradiction. As a consequence, AB and BD are incommensurable.

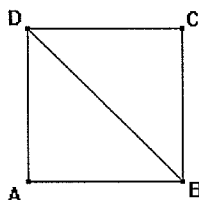

He preferred an indirect proof, which developed outside the geometric field and had the power of convincing but without explaining, to a direct proof, as for example a proof by *antifaieresis*, which would remain within the realm of geometry.

A proof by *antifaieresis* is a proof by subsequent divisions. Let us consider the square ABCD and prove that the diagonal AC and the side AB are incommensurable. The proof by *antifaieresis* works as follows.

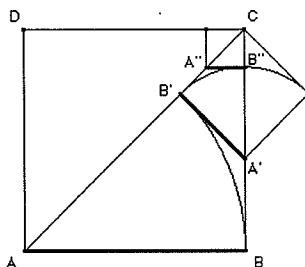

Let us assume, by contradiction, that a segment  $\epsilon$ , which is common sub-multiple to AB and AC, that is

$$\text{side: } AB = m\epsilon \text{ and diagonal: } AC = n\epsilon \quad (m, n \in \mathbb{N}).$$

We construct  $AB' = AB = m\epsilon$ . We do the perpendicular line to AC through B', obtaining A'. Triangles ABC and A'B'C are similar. So, since ABC is isosceles, A'B'C is isosceles too. Therefore  $A'B' = B'C = AC - AB' = (n-m)\epsilon$ . Now,  $A'B = A'B'$  because they are segments of tangents from the same external point A' to the circle of radius AB. Therefore  $A'C = BC - A'B = AB - A'B' = (2m-n)\epsilon$ . We can now consider a new square with

$$\text{side: } A'B' = (n-m)\epsilon \text{ and diagonal: } A'C = (2m-n)\epsilon.$$

Repeating the same reasoning with this square, we get another square with

$$\text{side: } A''B'' = (3m-2n)\epsilon \text{ and diagonal: } A''C = (3n-4m)\epsilon.$$

We repeat the same procedure and construct new squares. After a finite number of steps, we should get a square with side and diagonal less than  $\epsilon$ . On the contrary, going on with this procedure, we get a square with side and diagonal always greater than  $\epsilon$ . This is a contradiction, which comes from the assumption that AB and AC are commensurable. Therefore AB and AC are not commensurable.

This last method shows better than the one relying on odd and even numbers, how you get to an infinite process and consequently why side and diagonal of a square are incommensurable. This proof however includes a consideration about infinity and could then be rejected by a listener who asked questions about what happens to those smaller and smaller quantities.



---

proofs, and they had never talked about the methods which led them to the discovery of proofs. The critics bring forward the new characteristics of the 17<sup>th</sup> century proofs. As Arnaud and Nicole (1662) say, the main criticisms of Euclid were the following: focusing more on certainty than evidence and on convincing rather than illuminating; proving things that do not need to be proven; using many proofs by contradiction, which do convince without illuminating, as one is not satisfied only by knowing that something exists but wants to know why it exists; making use of knowledge outside the field of the proposition to prove; not explaining a method to construct proofs. Illuminating and method became two keywords for proof in this century. The function of proof changed from convincing a listener to **illuminating oneself** about the truth of a proposition. And if deductive reasoning served the purpose of constructing an argument to convince someone, the way to illuminate was thought to be the elaboration and explanation of solution methods, named **discovery methods**<sup>2</sup>. The importance of methods is stressed by Descartes, who was convinced that the ancients owned the art of invention but preferred to be admired for the presentation of sterile truths, proven with logical rigour, instead of teaching their art, which would have been admired by their contemporaries<sup>3</sup>.

However the problem of establishing the validity of these methods as proofs arose. These methods illuminated, as they showed the way to get to the result and they brought evidence. The geometers of the 17<sup>th</sup> century relied on evidence, which was considered to be a source of certainty. In 1823 Legendre defined a theorem as “a truth which becomes evident by means of a reasoning called proof”. But should what is made evident be considered proven?

In the same period Bolzano in his *Rein Analytischer Beweis*<sup>4</sup> (1817) made a strong opposition to the notion of proof as “evidence-maker”; according to him a proof must be a foundation, and what provides a foundation for a proposition is the possibility of establishing relationships between this proposition and other propositions. A new keyword appeared: **relationships**. And a new meaning for proof was to be established. The 20<sup>th</sup> century conception of proof was based on syntactic rather than semantic foundations. After the discovery of non-Euclidean geometries, mathematicians felt the need for re-discussing mathematical knowledge and finding secure foundations for it. Therefore the axioms took a

---

<sup>2</sup> For example, we can mention the methods of indivisibles, of tangents, the Cartesian method, the projective method, which are all methods to solve large classes of problems.

<sup>3</sup> In the 17<sup>th</sup> century people talked about an Archimedes' ‘secret way’, as the heuristic method he used to get to his results was not yet known. It was only in 1906 that this ‘way’ became known, thanks to the discovery of the book *The Method* by J.L. Heiberg: in this book Archimedes showed how to get to some of his most valuable results.

different status: they were no longer self-evident truths (as for Euclid) but pure hypotheses. Hilbert's *Grundlagen der Geometrie* (1899) does not assume any primitive intuition of geometric objects like point, line, and plane. All it is needed to know are the relationships, defined by the axioms, between different classes of objects. This change of perspective led to a definition of proof as a sequence of statements obtained starting from the axioms, which are hypotheses that do not have any ontological reality, by applying rules of logic. Certainty for mathematical theorems came from proving the non-contradiction of a theory. In this formalist movement, the idea of evidence no longer made sense: the reality of mathematical objects was the relationships between them. The aim of proving was to **ensure the logical consequence** between premises and conclusions.

Table **Error! No text of specified style in document..1** below shows the main characteristics of the three phases of the development of the concept of proving.

<b>Historical phases</b>	<b>Purpose of proving</b>	<b>Means of proving</b>
Euclid (6 <sup>th</sup> century BC)	Convincing a listener	Deduction
Descartes (17 <sup>th</sup> century)	Convincing oneself - Illuminating	Discovery methods
Hilbert (19 <sup>th</sup> -20 <sup>th</sup> century)	Ensuring logical consequence and non-contradiction	Formal systems

Table **Error! No text of specified style in document..1**. The three revolutions in the notion of proof

### 2.2.2 Different meanings and functions for proving

As discussed in the previous section, the characteristics and role of proof have changed over time, so that what was considered acceptable for one generation of mathematicians was found not rigorous enough for another generation. Where does all this lead us? What are the main issues for a present day discussion about the definition, role and function of proof? Trying to answer these questions is crucial when tackling issues of teaching and learning proof within school mathematics. It is necessary to distinguish and make explicit the relationships among different institutional contexts (Godino & Recio, 1997), i.e. it is necessary to make clear the distinction between the role and function of proof in formal logic, mathematics and school mathematics.

A first distinction has to be made between formal logic and mathematics. No mathematicians write formal proofs in the sense given by formal logic. Rav (1999) fixes a terminology, naming proof "a conceptual proof of customary mathematical discourse, having an irreducible semantic content" (p.11) and distinguishes this from derivation,

<sup>4</sup> Pure Analytical Proof

---

defined as "a syntactic object of some formal system" (p.11). While derivation is a technical term and admits a precise definition<sup>5</sup>, the meaning and aim of the term proof are not fixed in a technical definition, so that the subject of proof becomes a topic for philosophical discussion and analysis. A broad range of roles and functions for proof in the sense of Rav, are discussed by mathematicians and followed up by mathematics educators, with the aim of defining what roles and functions proof in school mathematics should have (deVilliers, 1990).

**Verifying-Establishing the truth.** Hanna (2000) argues that it is now generally accepted that "the only true test of the truth of a mathematical hypothesis is the existence of an acceptable proof" (p.21). And

a mathematical statement is held to be true if it is shown to be a logical consequence of accepted premises, that is, if it is derived from a set of axioms by the correct application of rules of inference. (Hanna, 2000, p.22)

Therefore a first role for proof emerges, that is establishing the truth of a statement. The traditional model of mathematics is described by Thurston (1995) as the definition-theorem-proof (DTP) model: mathematicians start from a few mathematical structures and axioms; there are important questions to be answered, which can be formulated as propositions; "the task of mathematicians is to seek a deductive pathway from the axioms to the propositions or to their denials" (p.30). Balacheff (1987) shares the same perspective, defining the process of proving as the organisation and implementation of a means to ensure the validity of a statement or of a decision. And, in substance, proving aims to ensure the absence of formal or semantic contradictions in the solution of a problem. The notion of contradiction is at the basis of proving, as the formalists (e.g. Hilbert) had pointed out. Hoyles (1997) says that, even if the term proof may have a variety of meanings in different institutional contexts, it has a distinctive role within the mathematical community:

It has traditionally separated mathematics from the empirical sciences as an indubitable method of testing knowledge which contrasts with natural induction from empirical pursuits. Deductive mathematical proof offers human beings the purest form of how to distinguish right from wrong. (p.7)

**Systematising.** Noss (1995) states that being able to connect a pattern with patterns that are already known is an integral part of mathematics. The function for proof of systematising is recognised by deVilliers (1990) and Thurston (1995). The main

---

<sup>5</sup> "A derivation in a formalised theory T is a finite sequence of formulas in the language of T, each member of which is either a logical axiom, or an axiom of T, or is the result of applying one of the finitely many explicitly stated rules of inference to previous formulas in the sequence" (Rav, 1999, p.11).

objective is not to check if certain statements are true but to organise unrelated statements that are already known to be true into a coherent unified whole (Sekigushi, 2000).

**Understanding.** In the eyes of practising mathematicians rigour is clearly secondary in importance to understanding and a proof becomes legitimate and convincing to mathematicians only when it leads to mathematical understanding.

Mathematical results published for a mathematical audience are invariably presented in the form of theorems and proofs. [...] To a person only partially trained in mathematics, [...] it might easily appear that the manner of presentation – with its possible implication that full rigour is the ideal form – is the core of mathematical practice. Thus competence in mathematics might readily be misperceived as synonymous with the ability to create the form, a rigorous proof. [...] When a mathematician reads a proof, it is not the deductive scheme that commands most attention. It is, in fact, the mathematical ideas, whose relationships are illuminated by the proof in a new way, which appeal for understanding. (Hanna, 1989, p.22).

So the function of understanding seems to be very important to practising mathematicians, despite what might appear from what mathematicians present to the public. Thurston (1995) stresses the fact that the reliability of a proof does not come from mathematicians formally checking its formal correctness, but it comes from mathematicians carefully thinking about the ideas involved in the proof. The idea of understanding goes along with the Cartesian conception of the importance of methods, that are ways to construct proofs which should illuminate. The recent computer proofs do not feel satisfactory to most people because they do not provide understanding. Having a printed list of the first 10,000 prime numbers does not tell anything about them, it is an answer that does not provide any kind of understanding. The same thing happens for zero-knowledge proofs (Blum, 1986; Hanna, 1996). The main principle underlying these proofs is the fact that the person proving a theorem has to show evidence that a proof exists but does not need to provide any direct information on the proof itself. One thing that makes mathematics different from almost all other fields of human activity is that in mathematics it is not sufficient to see a pattern, it is necessary to understand it (Noss, 1995). According to Polya (1954), understanding and conviction are necessary conditions for proving: when you have satisfied yourself that the theorem is true, you start proving it.

**Explaining why.** Proof is not only a question of making sure, but a question of explaining why (deVilliers, 1990). In fact, empirical or quasi-empirical verifications do not provide any explanation for why a conjecture is true. Hersh (1993) identifies the purpose of proof in school mathematics as that of explaining. In fact students are very easily convinced and do not need a proof for that. A proof should then provide insight

---

into why a theorem or property is true. He presents what he calls a Humanist view of the role of proof in teaching. Humanists believe that proof is complete explanation. Proofs are not obligatory rituals and teachers use most enlightening proofs, with the purpose of understanding and explaining why. Hoyles (1997) states that

maybe school proofs, where the content is given, should aim to provide insight as to why a statement is true and throw light upon the mathematical structures under study than seek only to verify correctness. (p.8)

**Discovering.** Rav (1999) imagines that a computer program exists, named PYTHIAGORA, which can decide whether a conjecture is true or not. You just type it in and you will be provided with an answer: yes or no. Mathematicians would then need only to produce conjectures and let PYTHIAGORA discriminate between true and false.

What a paradise! What a boon! Did I say boon? Nay, I say, no boon but doom! A universal decision method would have dealt a death blow to mathematics, for we would cease having ideas and candidates for conjectures. (Rav, 1999, p.6)

Rav argues that the essence of mathematics is in inventing methods, tools, strategies and concepts for solving problems. But methodological and conceptual developments presuppose the search and discovery of proofs, so establishing links between theories and systematising knowledge. "Proofs, I maintain, are the heart of mathematics, the royal road to creating *analytic tools* and catalysing growth" (Rav, 1999, p.6), as a means of exploration, analysis, discovery and invention. The view that new mathematical results are discovered only by intuition and then proven deductively, does not correspond to what really happens and happened in the past. For example, Rav (1999) shows how the various attempts to prove the Goldbach conjecture acted as a catalyst for remarkable developments of methods and discovery of other properties.

**Communicating.** Many authors stress the importance of proof also in the role of communicating mathematics (Thurston, 1995; Balacheff, 1998).

This entails developing mathematical language that is effective for the radical purpose of conveying ideas to people who don't already know them. Part of this communication is through proof. (Thurston, 1995, p.33)

"An appreciation of proof arises partly from a desire to examine how things "hang together" (curiosity) and to communicate this understanding tidily" (Watson, 1995, p.17). The social role of proof is mentioned by Tahta (1995): "In the last resort, proof is a social activity and the ultimate sense of truth, as the philosopher David Hume pointed out, is that which is derived from the voluntary agreement of others" (p.3). As carriers of mathematical communication, proofs depend much on the audience (Thurston, 1995; Rav, 1999). "We prove things in a social context and address them to a certain

audience" (Thurston, 1995, p.36). The same proof can be communicated in two minutes to mathematicians in the same field or may require two hours for mathematicians from a different field beginning to understand it. As Rav (1999) points out, proof is an infinitary object: how far one has to go into the explanation of a proposition of the form 'B follows from A' totally depends on the agents involved.

From the previous discussion, different functions of proof related to mathematics and school mathematics appear (Figure **Error! No text of specified style in document..1**). This broad range of meanings and functions for proving has important didactical consequences, in that it is important to make clear which meaning of proof teachers and students refer to when dealing with proof.

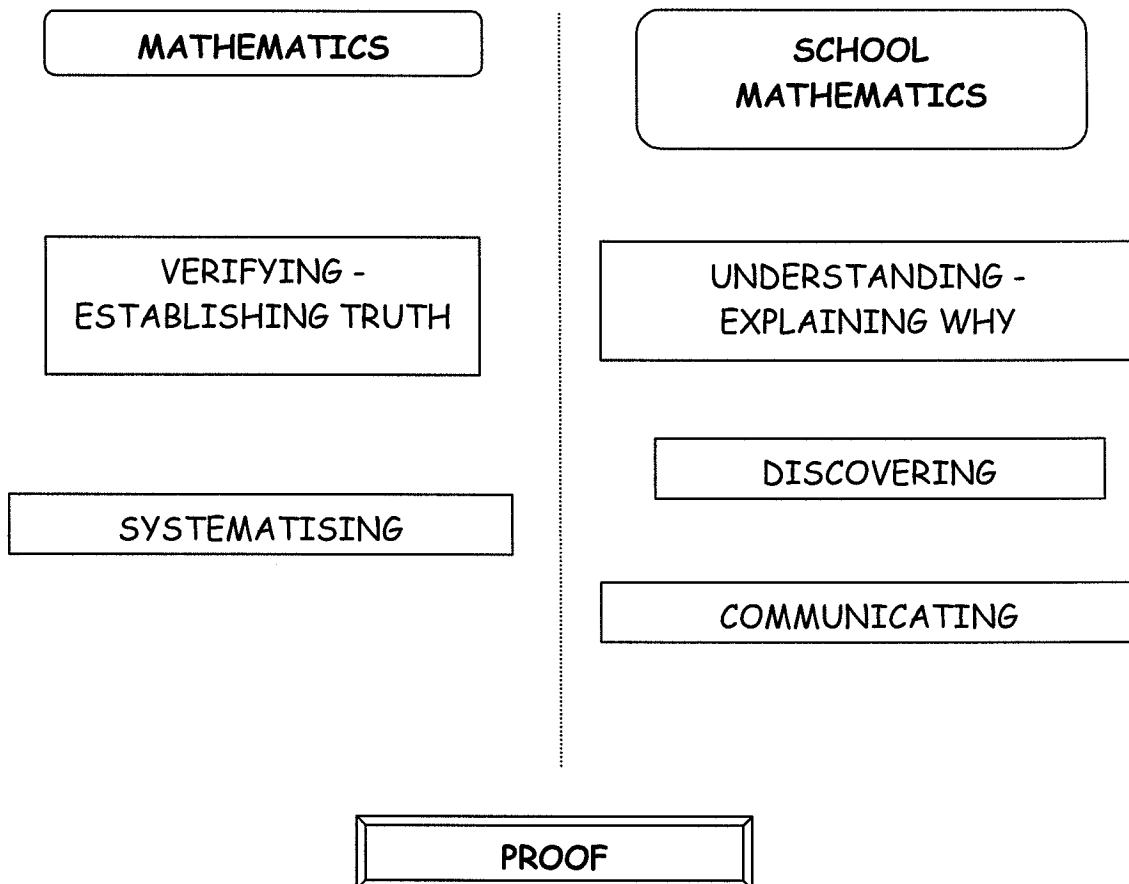

Figure **Error! No text of specified style in document..1**. Proof in mathematics and in school mathematics

### 2.2.3 Experimenting, exploring, conjecturing and proving

One-on-one, people use wide channels of communication that go far beyond formal mathematical language. They use gestures, they draw pictures and diagrams, they make sound effects and use body language. [...] With these channels of communication, they are in a much better position to convey what's going on, not just their logical and linguistic facilities, but in their other mental facilities as well. (Thurston, 1995, p.32)

---

When constructing or understanding a proof, lots of interplay between, transitions from-to, transformations of-into take place, as emerges from the previous quote. This brings us to consider the relationships between different activities related to proof, i.e. experimenting, conjecturing and proving. In her review of the history of proof, Barbin (1988) shows how the definition of rigour and formalism for a proof with respect to conjectures has evolved over time and is linked to the socio-cultural climate of the time. Different positions concerning the relationship between the three activities mentioned above are discussed by mathematicians. Some authors have emphasised the central role of formal proofs in mathematics, in opposition to the heuristics used in the discovery process, while others have stressed the fundamental role of heuristics compared to formal proofs (Cellucci, 1998).

This issue was raised in particular after the recent developments of proofs, which make use of computers. Horgan (1993) predicted "the death of proof", referring to the fact that with the use of computers to create and validate long proofs, which produce a fallible answer, mathematicians will not be able to produce statements which are other than provisionally true, that is they keep the status of conjectures. Or, on the contrary, it may be that conjectures will have the status of proven statements. Horgan observed that many mathematicians, when using computers to produce an experimental confirmation of mathematical properties, seem to be working outside the bound of deductive proof. Even if mathematics is not usually associated with experimentation and empirical investigation, mathematicians have often carried out experiments to discover or test conjectures. Mathematicians in the past would certainly have carried out many more experiments if they had had the physical possibility of doing that. What is new nowadays is that mathematicians spend a lot more time in experimenting rather than proving, so that they would like experimentation to have its own status (Hanna, 1996); experimentation seems to have become an alternative to proving and an equally valid means of validation in mathematics. The foundation in 1991 of the journal *Experimental Mathematics* corroborates this point. This journal publishes results obtained from explorations with calculators rather than theorems and proofs. However the editors underline how experimentation fits within the mathematical model:

Note that we value proofs: experimentally inspired results that can be proved are more desirable than conjectural ones. [...] The objective of *Experimental Mathematics* is to play a role in the discovery of formal proofs, not to displace them. (Epstein & Levy, 1995, p.671)

The extreme position of seeing exploration and production of conjectures completely separated from the production of proof, is shared by other authors, as for example by Jaffe

& Quinn (1993) in a famous paper which raised a strong and long debate among mathematicians. They underline the importance of making a clear distinction between results based on a rigorous proof and those based on heuristic arguments. They imagine a future scenario in which two trends in mathematical activity will proceed separately: a rigorous mathematics, which cannot do without proofs, and a speculative mathematics, which is based on heuristics and conjectures. So they propose that heuristic results are isolated as a separate category.

Mazur (1997) discusses "the growth of conjecture as a formal tool in Mathematics" (p.198). The noun *conjecture* has had a standard meaning over time, that is "an opinion or supposition based on evidence which is admittedly insufficient" (p.207), but it appeared in the mathematical or scientific vocabulary relatively recently.

Of course, some manner of conjecturing has always been present as a vital, but informal, penchant of mathematicians: how else does any mathematics progress except by questions whose answers are guessed at, except by waves of surmises? But such "plausible reasoning" (to use Polya's phrase) had been kept somewhat to the sidelines until recently (p.198).

The presence of books devoted to the exposition of conjectures, means that recently the art of conjecturing has achieved a considerable prominence in the mathematical landscape. Mazur (1997) believes that "formalisation of conjectures" is good for mathematics, especially now that theories are becoming more and more complex. The formulation of conjectures serves "to allow the field to proceed" (p.199).

The distinction made by Jaffe & Quinn (1993), even if maybe useful at a theoretical level, is totally counterproductive at the level of practice: in fact mathematical exploration makes use of deductive reasoning (Epp, 1994). Polya (1957) for example shows that deductive reasoning is crucial in the problem solving activity and exploration. Solving a problem means finding a connection between data and unknowns, and in order to do that one must use a "heuristic syllogism", that is a kind of reasoning which uses deduction together with inductive, statistical and circumstantial induction. Considering a heuristic conclusion as certain may be risky, but non consideration of such a conclusion at all may be an obstacle to progress. All most important signs of progress are of a heuristic nature (Polya, 1957). Therefore, in the process of solving a problem, a crucial point is a dialectic between the exploratory phase and the subsequent phase in which all the elements discovered informally are reorganised into validated statements.

Exploration and proof have been and are clearly complementary. [...] Exploration leads to discovery, while proof is confirmation. Exploration of a problem can lead one to grasp its structure and its ramifications, but cannot yield an explicit understanding of every link. Thus exploration can



---

lead to conclusions which, though precisely formulated, must remain tentative. It is proof which, by providing a derivation from the premises, firmly establishes the conclusions. (Hanna, 2000, p.30)

The conclusion from this section is that experimentation, exploration, conjecturing and proving are strictly connected and part of the same activity, and they are all used by mathematicians when dealing with proving.

### **2.3 PROOF IN THE CURRICULUM**

The role which proof should have in the mathematics curriculum is one of the issues discussed in the current research debate around proof. Before examining ways of teaching and learning proof in the classroom, the international scene regarding the presence of proof in the curriculum is established, focusing in particular on the English and Italian situation. The roots for the current situation are tracked down.

In some countries proof has been disappearing from the curriculum (Hanna, 1996) and then reappearing back again very recently (e.g. the UK and the US) while in some other places it has always been a very important part of the curriculum (e.g. Italy and France). The main reasons for the abolition of proof from the curriculum are to be found as a reaction to the formalist movement (Hanna, 1989). In the 50s and 60s teachers were faced with poor performances of students in constructing formal proofs, which were part of the curriculum almost everywhere, as part of the New Math movement. The concept of proof had turned into a meaningless ritual (Wu, 1996). As a reaction, the back-to-basics movement of the 70s virtually eliminated proof from the curriculum. Different developments after that were then observed.

The most influential curriculum-reform proposal of recent times has been the one established by the National Council of Teachers of Mathematics in the United States in the form of the *NCTM Standards* (National Council of Teachers of Mathematics, 1989; National Council of Teachers of Mathematics, 1991). This document de-emphasised proof in school mathematics, choosing instead to emphasise reasoning. The goal of the *NCTM Standards* was mathematical literacy, which was supposed to be achieved through conjecturing, exploring, validating conjectures, questioning one's own reasoning and the reasoning of others. But it did not include proof, which was referred to only in the context of preparation for post-secondary education. This seemed to suggest that proof was not essential for mathematical literacy at secondary level (Hanna, 2000). Therefore the transition to proof was abrupt when students entered university (Moore, 1994). However, a reconsideration of proof in the curriculum has been taking place recently in the United States. Schoenfeld (1994) suggested that "proof is not a thing separable from mathematics

as it appears to be in our curricula; it is an essential component of doing, communicating and recording mathematics" (p.22). Reflecting on the awareness of such kind of criticism, the documents which define the NCTM Principles and Standards for School Mathematics were revised and transformed in the *NCTM 2000* (AAVV, 2000). We read in the *NCTM 2000* that

More broadly, it should be stressed that exploring, conjecturing, representing, and proving are all deeply connected aspects of mathematical thinking. "Reasoning" and "Proof" should not be thought of as separable from the bulk of mathematical activity. They cannot simply be taught in a single unit on logic, for example, or by "doing proofs" in a geometry course. Rather, reasoning and proof must be a consistent part of students' mathematical experience in grades pre-K-12.

In the UK, the 'meaningless routines', which were taught in school in the 60s and 70s, were substituted with a process-oriented approach to proof, aimed mainly at testing and refining conjectures. The meaning 'to prove' was replaced by social argumentation and justifying was confined to an 'investigations curriculum' (Hoyles, 1997). Noss (1994) observed that

some educators are convinced that proof in the curriculum is a barrier to investigative and creative activity, and that it is inherently (sic) opposed to the spirit of exploration and investigation which has permeated the UK mathematics curriculum for much of the recent past (p.6).

In the revised National Curriculum for mathematics in England and Wales (Department for Education, 1995), proof had become inaccessible to the majority. It was only at Level 7 or 8 of AT1<sup>6</sup> that students were expected to prove their conjectures in any formal sense, while the majority of students were asked only to engage in data generation, pattern recognition and inductive methods (Hoyles, 1997). This means that most students were not given the possibility of appreciating the importance of logical arguments in whatever form. Moreover, proving and proof was to be found in the AT1 "Using and Applying Mathematics", so that all the functions of proof were separated from other mathematical content. For example students were expected to use theorems in AT3 "Shape, space and measures" while their proofs were put somewhere in AT1, so that proofs concerned already known and used facts (theorems). Together with proof, geometry was given less and less attention in the school curriculum. In the English National Curriculum:

geometry as the introduction to a global deductive system in school has been replaced by occasional references to knowledge and use of facts and investigations of how to prove isolated theorems. In this way any suggestion of a global mathematical theory built from explicit deductive foundations has been lost. (Tall, 1995, p.28)

In 1999, the National Curriculum 11-16 was revised, and proof seemed to be given a more important role. A reconsideration of the role of proof in the curriculum, and in particular the role of the teaching and learning of geometry, took place in the UK in the years 2000-2001.

---

The report *Teaching and learning geometry 11-19* was published, presenting the findings of a working group, which was established by the Royal Society and the Joint Mathematical Council between February 2000 and March 2001, in order to discuss "the rationale for a geometry curriculum, its possible content and issues concerned with its effective teaching" (The Royal Society & Joint Mathematical Council, 2001, p.xi). In the preface of the report, it is said that

the role of proof, and the range of pupils for whom it is relevant, remains a major issue in geometry teaching. [...]. Nevertheless, the working group supports the inclusion of proof in school geometry both because of its central role in mathematics, and as a contribution to developing more general skills of argument and criticism. (p.viii)

In Italy proof has been part of the curriculum for secondary school since the 1930s (with the Gentile reform) and is prevalently tackled within a geometrical context. The elaboration of a broad range curriculum reform started in the year 2001 (in the context of a big school reform), but is not yet finalised. So, the current mathematics curriculum for secondary school refers to the Piano Nazionale per l'Informatica (P.N.I.)<sup>7</sup> (circolare n°24, 6/2/91) and Brocca<sup>8</sup> (AAVV, 1991). In the comment on theme 1<sup>9</sup> (Plane and spatial geometry) in the P.N.I. programmes we read:

Lo studio della geometria nel biennio ha la finalità principale di condurre progressivamente l'allievo dalla intuizione e scoperta di proprietà geometriche alla loro descrizione razionale; a ciò il docente può pervenire adottando un metodo che, facendo leva sulle conoscenze intuitive apprese dallo studente nella scuola media, proceda allo sviluppo razionale di limitate catene di deduzioni, dove ogni ipotesi o ammissione a cui si farà ricorso sia chiaramente riconosciuta e formulata in modo esplicito. Al docente compete poi l'impegno di avviare la fase euristica su processi di assiomatizzazione partendo da semplici situazioni assunte nei vari campi; questo per permettere una familiarizzazione con il metodo ipotetico-deduttivo e pervenire negli eventuali studi successivi alla costruzione di un sistema di assiomi per la geometria elementare; a tal fine è bene programmare una scelta di proprietà delle figure piane da dimostrare.<sup>10</sup> (circolare n°24, 6/2/91)

---

<sup>6</sup>AT1 is Attainment Target 1 of the National Curriculum. Pupils aged 11-14 years should be within the range of Levels 3 to 7.

<sup>7</sup> The first formulation of these programmes was in 1985.

<sup>8</sup> The Brocca programmes followed the P.N.I. programmes and were part of a proposal for a major project to reform schools which never took place.

<sup>9</sup> The mathematics curriculum is divided into five main themes, which contain both content and methodological suggestions.

<sup>10</sup> The main aim of the study of geometry in the first two years of secondary school is to lead students to the intuition and discovery of geometric properties and to their rational description; for this purpose, the teacher will adopt a method which starts from the intuitive knowledge students have from the previous school years, and proceeds to the rational development of limited chains of deduction, where all premises and assumptions are explicitly recognised and formulated. The teacher is then required to start the heuristic phase upon axiomatisation processes, starting from simple situations; this is to familiarise with the hypothetical-deductive method and to get to the construction of a system of axioms for elementary geometry in the following years. It is good to make a selection of geometric properties to teach.

The general objectives of the curriculum related to proving are: developing logical and intuitive abilities; recognising logical concepts and rules in argumentative and proving contexts; proving geometric properties; making sense of formal mathematics symbols.

Given this panorama, teachers and researchers have been discussing the issue concerning whether proof should be part of the curriculum or not and argue for different positions. Many teachers do not seem to understand why mathematicians give such a central role to proof (Chazan, 1993). They do not think that "proof in the form of sound and original arguments actually occurs naturally in pupils' problem solving" (Wells, 1995, p.24) and they do not believe that pupils may be able to produce short chains of reasoning. The special issue of *Mathematics Teaching*, titled *Teaching Proof*, in which British researchers were asked to discuss the matter of inclusion or exclusion of proof in the curriculum (Barnard et al., 1996), reflects an ambivalent attitude to proof. The authors saw a dichotomy between developing investigative and problem-solving skills, which rendered mathematics "enjoyable", "useful" and a "human activity" to the eyes of the children, and teaching the less enjoyable and useful core skills needed to construct proofs. It was clear that heuristics was to come first. Hanna (2000), on the contrary, argues that exploration does not reflect the totality of mathematics, because mathematicians aspire to a degree of certainty that can only be achieved through analytical reasoning. Students should be shown that exploration does not constitute proofs. Moreover, even the most elaborated explorations can only show students *that* something is the case, but they do not explain *why* it must be the case. "True understanding demands that the students see *why* it is the case, and furthermore why it must *always* be the case, and this understanding is best engendered by a proof" (Hanna, 2000, p.31). Therefore Hanna (2000) affirms strongly that proof should be part of the curriculum, as

teaching mathematics without the concept of proof would be entirely unreflective of mathematical theory and practice. [...]. Proof is not a branch of mathematics. Students cannot be said to have learned mathematics, unless they have learned what proof is. They cannot understand the nature of mathematics until they have been shown that mathematics is unique among disciplines in its objects and methods. (p.24)

Moreover Hanna stresses the fact that students should both "study proofs and create proofs" (p.25). It has been argued that proof reinforces an authoritarian and elitarian image of mathematics (Ernest, 1991). But Hanna (1996) argues that this is not true, as in fact

it is in the very nature of proof that the validity of the conclusion flows from the proof itself, not from an external authority. Proof conveys the message that they can reason for themselves, that they do *not* need to defer authority. Thus the use of proof in the classroom is actually *anti*-authoritarian. (p.31)

---

Other researchers stress the need that the curriculum reflects the pivotal role that proof has in mathematics (Hoyles, 1997; Harel, 1998). "If proof is missed out, pupils miss out on one of the chief rewards of doing mathematics" (Wells, 1995, p.25) and the risk is that they think that generalisation and verification are always the final stages in mathematics.

This section has laid out the situation regarding the presence of proof in the school curriculum in different contexts. If we assume that proof is a crucial aspect of mathematics (as shown in section 2.2), then appropriate ways of introducing students to it should be found, as discussed in the following section.

## **2.4 TEACHING AND LEARNING PROOF IN THE CLASSROOM**

Generally speaking, teachers' experience of teaching proof shows problems and difficulties, across school sectors and countries. A number of researchers have investigated students' conceptions about and performances related to the construction and understanding of proof in mathematics, and related them to the ways proof is taught in the classroom, as discussed in this section. The main difficulties students have when approaching proving (both in understanding and constructing proofs) at secondary school level will be singled out, with particular respect to the context of geometry.

### **2.4.1 The learning perspective**

Dreyfus (1999) argues that, since students at present have a limited experience with proof in school mathematics (see section 2.3) they find the act of proving very difficult. "The ability to prove depends on forms of knowledge to which most students are rarely if ever exposed" (p.85). Therefore a possible reason for which students find proving hard is the fact that they are rarely asked to do this. The same consideration emerges from the study *Justifying and Proving in School Mathematics*<sup>11</sup> (Healy & Hoyles, 1998b). Healy and Hoyles show that the meanings students have appropriated are a consequence of the curriculum they are being taught and students' views of proof appear to shape their approaches to proving, so that the view of proof which is presented by the curriculum plays a very important role.

Research shows that students are not usually aware of what proof is about. It has been shown that usually students do not understand the meaning of the act of proving and when they are asked to prove a theorem, they cannot really make sense of it (Chazan, 1993; Harel

---

& Sowder, 1996; Healy & Hoyles, 1998b; Dreyfus, 1999). One of the main difficulties that have been highlighted in the literature is the fact that students prefer **empirical arguments to deductive arguments** when presented with mathematical problems (Chazan, 1993) and do not grasp the crucial distinction between them. Some research has shown that two sets of beliefs are possessed by students concerning this relationship. Some students believe that measuring and empirical evidence can allow one to reach a conclusion about the validity of a statement, which is considered to be a certain conclusion. Some other students view deductive proofs in geometry as proofs for a single case, the case which is represented by the diagram; they do not appreciate the "generic" aspect (Balacheff, 1988) of the diagrams in geometric proofs. Martin & Harel (1989) analysed the conceptions of pre-service elementary teachers in accepting or refusing correct or incorrect proofs presented in different forms. Their findings show that many teachers accepted inductive arguments as proofs of mathematical statements, and at the same time many teachers accepted deductive arguments as proofs. According to the authors, this difficulty reflects the fact that two kinds of reasoning are experienced by students: inductive reasoning in everyday life and deductive reasoning in mathematics. So apparently they need both types of reasoning to make sure of a statement. Hoyles (1997) identifies among the reasons for which proof is difficult, the fact that "proof requires the co-ordination of a range of competencies – identifying assumptions, organising logical arguments – each of which, individually, is by no means trivial" (p.7). Only a few students seem to be able to co-ordinate all competencies and make the passage from the empirical to theoretical for themselves (Healy, 2000a). However, Almeida (1996) and Hoyles (1997) have shown that many students are aware of the need for non-empirical methods for proving, even if most of them use empirical methods in establishing their results. The survey carried out with Year 10 students of England and Wales within the project *Justifying and Proving in School Mathematics* (Healy & Hoyles, 1998a) shows that students are capable of conjecturing and arguing using everyday language and most of them recognise that an empirical justification is not enough, but they do not know how to provide a formal argument.

Current research in the United States (Harel & Sowder, 1996) shows different students' conceptions of proof when they are 15-16 year-olds: they do not understand the role of **counterexample** in contradicting general statements, they do not see a proof as validation

---

<sup>11</sup> The project *Justifying and Proving in School Mathematics* was a longitudinal project (1995-98) which aimed to examine the impact of the National Curriculum on high-attaining year 10 students' views of and competencies in

---

of a theorem that does not require any other empirical verification, they think that a general proof aims at verifying a particular case or at establishing the truth of something that is intuitively evident or at verifying something you already know is true. Other research has shown the difficulty in identifying the **premises** of a proof and following the logical arguments from the premises to the conclusions (Martin & Harel, 1989; Chazan, 1993).

The influence of the appearance of the arguments, rather than their correctness is another obstacle (Martin & Harel, 1989), which shows a conception of proof as a meaningless **ritual**, in which the form is more important than the content (Hoyles, 1997). In the proof questionnaire from the project *Justifying and Proving in School Mathematics* (Healy & Hoyles, 1998a), the students were requested to choose among five proofs for a proposition which one was closest to the one they would construct and which one would get the best mark from the teacher. Students usually gave two different answers, pointing out that what they consider a proof to be may be different from what they have been told to be a proof. The same result appeared also with younger students (Küchemann & Hoyles, 2001). The questionnaire also shows that students usually prefer formal presentations (correct or incorrect) for proofs which are considered to get the best mark, while they prefer narrative proofs for their choice. "It seems that despite our investigation culture, the students have picked up what the game *should* be!" (Hoyles, 1997, p.13). Proof is considered a formal ritual, which needs to go along with any investigation, but does not provide understanding.

The two-column proofs taught in the United States often get the status of pure rituals: the students feel obliged to write down a justification which has no meaning for them. Moreover, "the imposition of justifications is a major contributor to the formation of symbolic reasoning and justification by virtue of **authority**, which extinguish all sparks of curiosity" (Harel, 1998, p.9). The role of authority is a delicate point. Even in classroom-based inquiry methods of teaching, "given that there exists a community of mathematicians who have considered the mathematics in question and who have far greater knowledge of the mathematics and experience with mathematical justification, students cannot reach maximal confidence until a member of that community validates the mathematical work in question" (Simon, 2000, p.166). Students may see in the teacher someone who can give them more confidence in their results, as a representative of the community of mathematicians.

Barbin (1988) points out that there may be an *epistemological obstacle*<sup>12</sup> due to the different conceptions of the function of proof students and teachers may have, which correspond to two different historical moments. Students usually want to be **illuminated** and the first need for proof arises from the construction of the mathematical objects themselves. How can they appreciate the importance of deductive reasoning? Teachers may answer that deductive reasoning is to convince, but pupils themselves only want to be illuminated. If one considers proving as equivalent to convincing, one may be convinced by the result, when reading a proof made by someone else, even without grasping the meaning of it. But being convinced is not sufficient, students want to be illuminated. On the other hand Hoyles (1997) stresses the fact that if the meaning of proof in school mathematics is to be only that of verification, then there will be many conceptual difficulties linked to proving.

If proof simply follows conviction of truth rather than contributing to its construction and is only experienced as a demonstration of something already known to be true, it is likely to remain meaningless and purposeless in the eyes of the students. (p.8)

However,

alongside the ritualised responses described above and the all too numerous solutions that simply resort to empirical examples, there are some fascinating and ingenious proofs which provide a pointer to the wealth of resources that might be tapped and built upon in the process of building a proving culture - of starting conversations with students about proof. (Hoyles, 1997, p.14)

#### 2.4.2 The teaching perspective

"Despite the long tradition for the inclusion of geometrical proof in school curricula there is little evidence that we have developed effective methods for its teaching" (The Royal Society & Joint Mathematical Council, 2001, p.viii). How is proving being introduced by teachers in the classroom?

One of the main concerns is to find situations, which **motivate** students to proving. Harel (1998) defines the Necessity Principle: "students are most likely to learn when they see a need for what we intend to teach them, where by "need" is meant intellectual need, as opposed to social or economic need" (p.501). The author singles out implications of the Necessity Principle for the teaching of proof. The first implication is that in justifying an assertion teachers must take into account students' intellectual needs, which may be different for different populations of students. So the proofs presented must be concrete, i.e. deal with entities that students conceive as mathematical objects, convincing, i.e. students understand the ideas behind and not only the single steps, and essential, i.e. students see the

---

<sup>12</sup> Bachelard (1938) defines *epistemological obstacle* as items of knowledge which, trying to be adapted to other situations, provoke either specific mistakes or stable knowledge. Refusing them is more difficult for students than trying



---

need for the justification of each step. The second implication concerns the role of drill and practice and its effect on students' mathematical reasoning. Harel stresses the fact that once a theorem is introduced as a ready-made object, the need for justification is totally absent, while until a mathematical relationship is declared a theorem, the students continue - either voluntarily when they need to use the relationship or upon request - to justify it. While recognising proof as the hallmark of mathematics, Kline (1973) has argued that its place is at the end rather than at the beginning, and that even in proof, rigour should play a lesser role than motivation. However the teaching practice appears to be different. Alibert & Thomas (1991) show that proofs are usually presented as already-made products, so that students are not allowed to participate in the process of construction of knowledge, they are only users. Teachers normally teach only the formal side of proofs: sometimes the first impact with this formalism does not allow students to deeply make sense of the real essence of the arguments involved (Goldenberg & Hazzan, 1995).

Based on the idea of proof to validate a statement, in France it is very common, in order to motivate students to prove, to develop situations in which students have to decide about the validity of a result, through a scientific **debate** involving conjecturing and proving. Hoyles (1997) suggests that a way to make students explain why a proposition holds, and not only to validate the proposition, could be adding a social dimension to proof. The communicating function of proof may be operationalised through activities, which involve students explaining their arguments to a peer or to the teacher. In this way students also have ownership of the proving activity. Perks & Prestage (1995) argue that teachers should ask young students from an early age to express their opinion more often. As in other subjects, teachers should offer mathematical tasks in which pupils have to present public arguments, where it is necessary for them to communicate their thinking clearly. They should encourage students to critically challenge explanations, justifications and proofs which are not clear. They should make students realise that if a proof is not convincing then it is not good enough. So the function of convincing and communicating for a proof merge together in an attempt to create a climate for proving. The importance of social interaction to create an environment which is suitable for situations of validation, is stressed by a number of researchers (Balacheff, 1987; Sekigushi, 2000; Simon, 2000). Sackur, Drouhard, & Maurel (2000) underline in particular the role conflict can play in such situations of interaction. Connected to this issue, the role of the teacher in this debate has been

---

to adapt to them, even if there may be costs in term of the solution process.

discussed. Barbin (1988) underlines the danger of considering proof as a social act aimed at convincing and of implementing the idea through scientific debate in the classroom. She believes that the constructivist belief concerning the role of the teacher to be marginal in the classroom, believing that the construction of knowledge happens naturally from the cognitive conflicts stimulated amongst the students, is wrong. Sackur et al. (2000) share the same idea and stress the importance of the teacher in setting out an appropriate learning situation, in which students can carry out a scientific debate, and in helping students to get the idea of the character of necessity of a proof in the phase of "institutionalisation" (Brousseau & Balacheff, 1997). At the same time, it is made clear that the character of necessity of a mathematical statement has to be experienced and cannot just be told by the teacher. Sackur et al. (2000) describe a teaching experiment in which first year university students were asked to work alone first, in order to enable them to activate their knowledge; then they worked in small groups, where they had to come up with an agreement around the validity of the statements they produced: the role of conflict was essential in this phase; finally the teacher institutionalised the statements produced. "The teacher is no longer the only person who knows; the knowledge, together with its necessity, is a common knowledge. In that way, one can say it is a mathematical knowledge" (Sackur et al., 2000, p.112).

Sharing the idea that proof is not aimed only at convincing but also at illuminating, Barbin (1988) says that situations in which the **processes** to produce a certain result are considered as important as the result itself should be implemented in the classroom. Sekigushi (2000) describes a teaching experiment conducted in junior high school in Japan. It was aimed at developing a method to teach proof. He made students write down a "file", which had the role of notebook, textbook and reference book. The students were asked to write down in one column their explanations or solutions of proof problems and in another column the teacher's comments, other students' solutions or any observations, figures, etc they wanted to make. The aim was to make them externalise (Bruner, 1996) their learning and to enable them to communicate it. "It seems that the files worked as a mediating tool between the classroom's discourse and individual's thinking" (Sekigushi, 2000, p.135). The conclusion the author draws is that students' files contained a rich expression of their thinking.

Usual symbolic writing in mathematics may appear simple and elegant, but it is not always the case for students, and has a danger of planting in students' minds an inappropriate belief: use of words is not important in writing and explaining mathematics. (p.136)

---

An interesting view about the role of the **reader-listener** in the communication of a proof is presented by Perks & Prestage (1995), who go along the line of Rav (1999), who discussed the issue from an epistemological point of view. It is said that

the burden of proof rests on the person offering the evidence, not the interested reader. Students can be encouraged to realise that if they are not convinced, it is not their fault, they should challenge, they should demand more detail, they should ask for the inclusion of the steps which are "obvious" to those offering the proof but necessary for someone looking at work for the first time. (Perks & Prestage, 1995, p.45)

Taking into account the audience relates to the need for discussing what proof should be taught in school mathematics, where the audience is formed by students and not by mathematicians (Dreyfus, 1999; Miyazaki, 2000b).

## **2.5 COGNITIVE THEORETICAL FRAMEWORKS AND TEACHING EXPERIMENTS**

Given all the difficulties involved with the teaching and learning of proof, but at the same time the need to enable students encounter it in school, there is a need to develop possible methods of introducing proof in the classroom in a way that allows students to face and overcome the difficulties. This section will discuss a number of cognitive frameworks which interpret students' difficulties with proof and proving and present some successful stories of students approaching theoretical thinking and proving, in the form of teaching experiments.

One of the main difficulties students show is distinguishing and using appropriately empirical and deductive arguments. A common interpretation of this has been to argue that students' understanding of proofs is organised along a hierarchy: empirical proof or validation is at the bottom, and is then transformed into deductive proof and reasoning, which are at the top. Some authors believe that a smooth transition from the bottom to the top can happen (Balacheff, 1987; Harel & Sowder, 1998; Maher & Kiczek, 2000; Miyazaki, 2000b), while others say that this is not possible (Duval, 1996). A different view sees an interplay among the different types of reasoning instead of a hierarchy (Hoyles, 1997). The following sections will discuss cognitive frameworks and teaching experiments according to their position with respect to this issue. Moreover, the relationship between exploring, conjecturing and proving will be addressed with respect to some studies.

### **2.5.1 A transition from empirical to deductive proof**

Balacheff (1982) studied students' proofs as products and provided a classification of proofs according to a continuum from empirical to deductive arguments. He identifies three types of proofs. "Preuves pragmatiques" (pragmatic proofs) are proofs involving real actions on

some representation of mathematical objects. "Preuves intellectuelle" (intellectual proofs) are detached from actions and talk about objects and their properties and relations. Finally, a "démonstration" (proof) is the formal mathematical proof. The evolution from pragmatic proofs to " démonstration" involves a change in the language used and in the status of the objects involved. Balacheff distinguishes different levels of proofs, from pragmatic to intellectual proofs, which constitute the basis for the development of a " démonstration ". "Empirisme naïf" (naïve empiricism) is the first type. It consists of drawing general conclusions from the observation of a small number of cases. The second type is the "expérience crucial" (crucial experiment). Validation takes place through the examination of a particular case which students consider the least particular. The "exemple generique" (generic example) consists in making explicit reasons for the validity of a statement by operations upon an object which is presented not as a particular object but as a representative of a class of objects. The "expérience mentale" (thought experiment) invokes action by interiorising it and detaching it from its realisation on a particular object. The operations and relationships which are at the basis of the proof are distinguished from the result they produce. The types described above are distinguished for different levels of detemporalisation, decontextualisation and depersonalisation.

Drawing on Balacheff's idea of levels of proofs, the study of Miyazaki (2000a) aims at "establishing levels from an inductive proof to an algebraic demonstration in lower secondary school mathematics" (p.47). He suggests that six levels can be established on the basis of three axes: contents of proof, representation of proof and students' thinking. As far as proof contents and representation, he identifies four types of proofs, putting on the contents axis "inductive" and "deductive" reasoning and on the representation axis "a functional language of demonstration" and "a language other than a functional language of demonstration, drawings, and/or manipulable objects" (p.53). Adding students' thinking, he gets other two levels of proof. He suggests an order in which the shift between the levels should take place and advocates the development of curricula that foster these shifts. Among these six levels, one key level plays the same role as the generic example in Balacheff, as the germination of deductive proof.

Harel & Sowder (1996) classified students' "proof schemes<sup>13</sup>" in three broad categories. Each of them represents a cognitive level and the classification does not concern the

---

<sup>13</sup> "An individual's proof scheme consists of whatever constitutes ascertaining (convincing oneself) and persuading (convincing others) for that person" (Harel & Sowder, 1996, p.60).

---

content of proofs nor methods and it is not an a-priori classification. The first category is “schemes of external conviction”. When formalisms are introduced too early, students learn that mathematical justification coincides with ritual and form. When the teacher is the only source of knowledge for students, they cannot become confident in their abilities to create and do mathematics. All these habits lead to the creation of schemes of external conviction. Doubts about the validity of an observation are eliminated through: the ritual presentation of an argument (“ritual scheme”), the words pronounced by an authority (“authoritarian scheme”), the symbolic form of arguments (“structural scheme”). The second category is “empirical schemes”. Conjectures are validated or rejected on the basis of physical evidence or experience. The authors distinguish two types. There is an “inductive scheme” when students convince themselves or others about the validity of a conjecture by quantitative evaluations (i.e. measuring, using numbers) of the conjecture in one or more specific cases. There is a “perceptual scheme” when there are perceptual observations done with rudimental mental images, which consist of perceptual activities (visual and tactile), but fail to have the capacity of transforming objects and anticipating the results of the transformations. The third category is “analytical schemes”. Conjectures are validated through logical deductions. Two types occur. There is a “transformational scheme”, when observations involve operations with objects and anticipation of the results of these operations. It is characterised by: generality of conjectures, mental operations with an aim and anticipatory aspects and transformation of images through a deductive process. The “axiomatic scheme” occurs when the subject understands that a mathematical justification originates from undefined terms and axioms. Harel & Sowder (1998) point out that “the classification of students’ proof schemes is not hierarchical, but should be looked at as a possible model of development in a subject”. They suggest the model in Figure **Error! No text of specified style in document.**2. A person can show the presence of different schemes in a short period of time, which reflect his/her familiarity and experience in a certain context, together with his/her “sense” of what kind of justification is appropriate to the environment he/she is in. External conviction schemes and empirical schemes are usually classified as negative, while the only ‘good’ schemes are considered to be the analytical schemes. According to Harel & Sowder this vision is too simplistic. It is normal that when doing proofs, students try to observe reality and to satisfy the teacher’s authority. The problem is to act in such a way that they do not remain at this level for ever. Teachers should be aware of the existence of all these schemes and construct activities to lead students towards the transformational scheme, which is considered to be the pivot of proof

schemes. It can be considered as the link between argumentation and proof, so that in this way the transition from the former to the latter could happen naturally. However it is not yet clear how the transition from a perceptual scheme to a transformational scheme may happen.

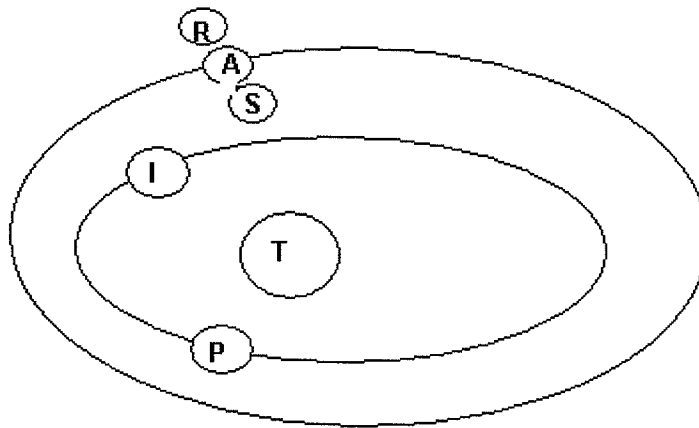

T= transformational scheme, I=intuitive, P=perceptual, S=structural, A=authoritarian, R=ritual.

Figure Error! No text of specified style in document..2. Students' proof schemes (Harel & Sowder, 1996)

Maher & Kiczek (2000) describe a long term teaching experiment in which the same students were given the same problem (the Pizza Problem<sup>14</sup>) every year for seven years since Grade 5, with the aim of constructing the addition rule for Pascal's triangle. Their findings show that the students' representations and notations became increasingly more abstract and general over time. The properties of combinations grew from very concrete images. Once these properties emerged, the students linked the prior concrete images into a larger framework that included connections with other ideas in algebra and combinatorics.

### 2.5.2 Argumentation and proof: two different cognitive functionings

Linked to the problem of the transition from inductive to deductive reasoning, from pragmatic proofs to “demonstrations”, from schemes of external conviction to transformational schemes, is the relationship between proof and argumentation. The consideration of argumentation in mathematics education is relatively recent (Duval, 1996). Duval (1991; 1996) defines a cognitive distance between argumentation and proof. Duval (1991) states that argumentation and proof have two different cognitive functionings, and therefore the development of argumentation, even in its more refined forms, does not lead

to proof. Deductive reasoning and argumentation require specific and independent development. He defines argumentation as the kind of reasoning which is intrinsically linked to natural language and appears spontaneously in any situation in which a justification or conviction is required. In any proving activity it is deductive reasoning which reveals a decisive task. Superficially, these two types of reasoning have similarities, but if we examine their cognitive functioning they present many essential differences, as shown below. In the functioning of a process of reasoning two steps are identified: a reasoning step, called "inference" step and the transition from one step to the following one. The "inference" step is the passage from some premises to some conclusions thanks to a given rule. In a deduction, the inference step has a ternary organisation, as represented in Figure Error! No text of specified style in document..3.

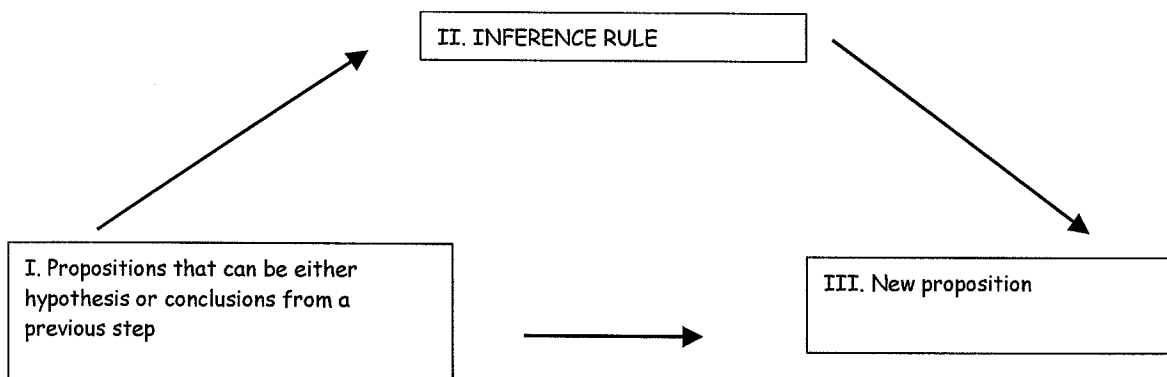

Figure Error! No text of specified style in document..3. Inference step in a deduction (Duval, 1996)

Only three possible "operative statuses" are possible for a proposition in a deductive step: entry proposition, inference rule and conclusion. The inference rule is what allows the passage from a proposition to another one in a proof step; inference rules can be definitions, axioms, already proven theorems. In a deductive step, propositions do not intervene as functions of their content, but only as functions of their operative status. And the status of a proposition may change according to different situations: for example the same proposition may be a hypothesis first, and then be used as an inference rule. The connectives indicate only the operative status of propositions. In argumentation, proposition do not have an operative status. The inference is based on the content of the propositions. The natural language connectives are important, as they show the relationship between two propositions: opposition, justification, explanation, consequence, etc.

<sup>14</sup> The Pizza Problem is a general mathematical problem asking to find how many different pizzas can be made using any number out of, say n, different topping choices and to consider how to account for organisations of pizzas as additional toppings are made available.

---

Based on the different cognitive functioning of argumentation and proof, Duval (1991) points out that one of the key elements to learning proof could be the recognition of this difference and proposes a teaching experiment based on this idea. According to Duval, in order to introduce 13-14 years old children to deductive reasoning, it is necessary to structure a situation which requires the use of propositions in function of their operative status (entry proposition, inference rule or conclusion) and not only of their content. In order to do this, the task should separate the deductive organisation of the proposition from the linguistic production of a text, which would focus the attention on the content, and the activity of the students should aim at the elaboration and control of this deductive structure only and should not coincide with the search for a solution to the problem. Duval then carried out a teaching experiment in which two tasks were proposed to students: first, the construction of an "oriented propositional graph"<sup>15</sup> and then the elaboration of a text-proof. The teaching experiment was organised in two phases: the search for a solution to the problem, which ends with the selection of definitions and theorems to use, and the deductive organisation of the propositions into a graph, followed by a written report which is then transformed into a proof. The findings report a considerable qualitative improvement in students' productions over the experiment. The researchers considered signs of success the following things: the presence of all the characteristics of deductive reasoning as they were pointed out in comparison to argumentation, in particular as concerns the deductive application of theorems, which were presented in their correct status, as rules which allow the passage from a starting proposition to a conclusion; the deep change in the attitude towards the search for a solution, as students seem to develop heuristics strategies more effectively, once they know the functioning of proof.

Duval's view has been either taken on board or criticised from different researchers. Mogetta (2001) states that there are "undoubted differences between the argumentative and the proving discourse" (p.375) from the epistemological point of view. But from the cognitive point of view, a unity between them seems possible. Douek (1999) in the same way says that "in spite of the undeniable epistemological and cognitive distance between ordinary argumentation and formal mathematical proof, argumentation and ordinary mathematical proof have many aspects in common, both as processes and as products" (p.273). Pedemonte (2001) states that argumentation and proof are similar and can be compared from two points of view: content and structure. Her study shows how structural

---

<sup>15</sup> An "oriented propositional graph" concerns the organisation of proposition according to their operative status



---

analogies and changes between argumentation and proof during the solution of geometrical problems involving the construction of conjectures and proofs within Cabri-Géomètre can be detected and explained through Toulmin (1958)'s model for the structure of argumentation.

### 2.5.3 Alternative views: an interplay among different types of reasoning

All the developmental schemes discussed in section 2.5.1 take into account essentially the transition between two forms of reasoning: empirical/inductive and deductive. Inductive reasoning consists in drawing general conclusions from particular instances, while deductive reasoning consists in a chain of steps in which each step follows necessarily from the previous one. Simon (1996) states that this distinction is not sufficient to describe students' reasoning: a third type of reasoning exists and is called **transformational reasoning**. His hypothesis is based on classroom observations, where he found types of reasoning which could not be classified as inductive or deductive. Simon presents a clarifying example of transformational reasoning. Some prospective teachers were asked to find ways to determine the area of an amoeba-shaped figure drawn on the blackboard. One student suggested to put a string following the perimeter of the figure and then to make a rectangle with that piece of string. This strategy provoked group discussion around its validity. Simon observed that the students were not collecting data, so they were not reasoning inductively, but at the same time they were not trying to prove their strategy deductively. Three elements characterise this reasoning: the validation process is neither inductive nor deductive, the students understand that they are able to know if the string conserves the area by doing some physical manipulations of the string itself and they show a spontaneous desire to pursue this strategy. According to Simon (1996), they are trying to make sense of how the mathematical system works.

*Transformational reasoning* is the mental or physical enactment of an operation or set of operations on an object or set of objects that allows one to envision the transformations that these objects undergo and the set of results of these operations. Central to transformational reasoning is the ability to consider, not a static state, but a dynamic process by which a new state or a continuum of states are generated. (p.201)

In this definition the "mental enactment" of an operation refers to operations with mental images. Transformational reasoning is supported by reproductive or anticipatory images (Piaget & Inhelder, 1969). In any case, the subject is able to visualise the transformation resulting from an operation. However, transformational reasoning is not limited to mental images. A physical enactment may be used to examine the result of a transformation. A

mental anticipation is however needed in order to decide to model the situation in a transformational way. The function of understanding and validation come together in transformational reasoning.

Other researchers (Hoyles, 1997) question the existence of a universal hierarchy of "proving competencies" (p.8) in which the empirical precedes the deductive, saying that there seems to be no natural progression from empirical to theoretical reasoning (Healy, 2000a), but all of them should interact productively (Simon, 2000). "Is it a matter of development of the latter from the former or can links be forged between the two at every stage of schooling and throughout mathematical activity?" (Hoyles, 1998, p.169). Another classification of proofs is presented in the project *Justifying and proving in school mathematics* (Healy & Hoyles, 1998a), which does not imply a hierarchy: students' proofs are classified into empirical, enactive, narrative, visual and formal.

The relationships between empirical and theoretical activities are to be linked with the relationships between the process of producing conjectures and the construction of proof. Based on the idea that the production of a conjecture and the search for a proof are strictly connected, as the geometers of the 17<sup>th</sup> century had argued, the construct of "cognitive unity" was developed by an Italian research team. A teaching experiment concerning the production of theorems (Boero, Garuti, & Mariotti, 1996b; Boero, Garuti, & Mariotti, 1996a), within the field of experience (Boero et al., 1995) of sunshadows was carried out with 12 year old children. Classroom observations showed evidence of a "cognitive unity" between the production of conjectures and the construction of a proof. The Cognitive Unity was then expressed in the following terms:

During the production of the conjecture, the student progressively works out his/her statement through an intense argumentative activity functionally intermingled with the justification of the plausibility of his/her choices: during the subsequent proving stage, the student links up with this process in a coherent way, organising some of the justifications ("arguments") produced during the construction of the statement according to a logical chain. (Boero et al., 1996b, p.113)

Therefore the differences described by Duval (1996) between argumentation and proof may actually interact in a dialectic which evolve within the classroom culture. Boero, Garuti & Lemut (1999) identified different ways of generating conditional statements in students' protocols, and suggest that this is a key point for the consequent generation of proofs. Based on the idea of *cognitive unity*, Boero et al. (1996a) stress the importance of the processes of production of conjectures and proofs, as a way to support students in proving. The traditional approach to theorems presented as established objects is challenged, and interesting issues for the development of suitable learning environment to supports

---

students' proving activities are discussed. In particular, the key element to be considered is the connection between conjecturing and proving, which needs to be in some way stimulated. For example, the authors suggest that problems in which already established results are presented to the students to prove, may function against this connection and create an obstacle.

Douek (1999) shows some experimental evidence of the negative consequence of subordinating the proving process to the formal requirements of proofs as a final product. In her study with algebra undergraduate students, she observed that the more skilful students who aim at a formal presentation of the proof, carried out a linear research in the construction of the conjecture, often with long repetitive calculations and did not usually produce a complete proof. The most successful students were the ones who could employ different strategies and show flexibility in the construction of the conjecture, so that at the end the proof was almost there. She also noticed a critical use of semantic arguments beside the syntactic ones.

Studies concerned with proving processes have recently been taking into consideration the role of other types of reasoning as for example **abduction** (Arzarello, Micheletti, Olivero, Paola, & Robutti, 1998; Cifarelli, 2000; Pedemonte, 2001). Arzarello et al. (1998) analysed the performances of experts (high school and university mathematics teachers) dealing with elementary but non trivial open geometric problems in paper and pencil. The analysis ended up in a theoretical model which describes the way conjectures are produced by experts and how they manage the transition from the conjecturing to the proving phase. The main points of the model are the following.

*Ascending control* (Saada-Robert, 1989). This is the modality according to which the solver 'reads' the figure in order to make conjectures. The stream of thought goes from the figure to the theory, in that the solver tries to find the bits of theory related to the situation he is confronted with. This modality relates to explorations of the given situation.

*Abduction* (Peirce, 1960; Magnani, 1997). In the model, abduction means choosing 'which rule this is the case of', that is the subject browses his theoretical knowledge in order to find the piece of theory that suits this particular situation. Explorations are transformed into conjectures.

According to Peirce, of the three logic operations, namely deduction, induction, abduction (or hypothesis), the last is the only one "which introduces any new idea; induction does nothing but determine a value, and deduction merely evolves the necessary consequences of a pure hypothesis.

Deduction proves that something must be; induction shows that something actually is operative; abduction merely suggests that something may be" (CP, 5.171). Abduction looks at facts and looks for a theory to explain them, but it can only say a "might be", because it has a probabilistic nature. The general form of an abduction is:

a fact A is observed

if C was true, then A would certainly be true

So, it is reasonable to assume C is true.

An example illustrates this concept. Suppose I know that a certain bag is full of white beans. Consider the following sentences: A) these beans are white; B) the beans in that bag are white; C) these beans are from that bag. A deduction is a concatenation of the form: B and C, hence A; an induction would be: A and C, hence B; an abduction is: A and B, hence C (Peirce, 1960, p.372).

*Descending control.* This modality occurs when a conjecture has already been produced and the subject seeks for a validation. He/she refers to the theory in order to justify what he/she has previously 'read' in the figure and validates his/her conjectures.

The model shows that abduction plays an essential role in the process of transition from ascending to descending control, that is from exploring-conjecturing to proving. Abduction guides the transition, in that it is the moment in which the conjectures produced are written in a logical form 'if...then'; all the ingredients necessary for the proof are already present. This model suggests an essential continuity in the process exploring-conjecturing-validating-proving of experts dealing with proof problems.

## 2.6 THE PROVING PROCESS

Drawing on the main points emerging from the literature, in this section I will present the perspective on proof taken on board by this study.

As evident from the title of the thesis, this research concentrates on *proving* rather than *proof*. Instead of talking about proof as a result, I will talk about the *proving process*, defined as the process of constructing and entering the relationship *B follows from A*, or  $A \Rightarrow B$ , until the agents involved (in my case, the students) are satisfied with the explanation for the truth of the statement (convincing oneself). This explanation is a proof if it satisfies the rules of logical consequence. Rav (1999) describes the activity of proving which mathematicians undertake as "entering into" the relationship *B follows from A*:

In trying to understand the author's claim, one picks up paper & pencil and tries to fill in the gaps. After some reflections on the background theory, the meaning of the terms and using one's general knowledge of the topic, including eventually some symbol manipulation, one sees a path from A to A1, from A1 to A2, ... and finally from An to B. This analysis can be written schematically as follows:  $A \rightarrow A1 \rightarrow A2 \rightarrow \dots \rightarrow An \rightarrow B$ . (Rav, 1999, p.14)

The aim is

to let the interlocutor see a certain pattern, a series of links connecting chunks of knowledge. The chunks may be more or less large, according to the mathematical sophistication of the people

---

discussing. The links are logical. [...] A logical link is not a small step corresponding to some rule, but the subsistence of the relation of logical consequence. (Lolli, 1999)

The process of construction of the object  $A \Rightarrow B$ , which is a *proven conjecture*, e.g. a theorem (every theorem is a statement B for which there is another statement A such that B is a logical consequence of A), is so constituted of two phases: the construction of the conjecture and the construction of a proof. The *proving process* is both phases and, as such, it includes both a process and a product. In the first phase, while the subjects explore the situation and formulate a conjecture, they search for elements (e.g. properties) to be organised later on (this is the process), while in the second phase these elements are to be put in order according to the rules of logical consequence (this is the final product, which I will refer to as proof). Based on previous studies (Boero et al., 1996b), I include the exploration phase, in which bits and pieces are searched for and collected, as part of proving, because it contains key elements for the proof itself. A proof has to be a deductive text, however the process to get there may involve different forms of reasoning such as induction, abduction, etc and 'substantial' and not 'formal' arguments.

The reliability does not primarily come from mathematicians formally checking formal arguments; it comes from mathematicians thinking carefully and critically about mathematical ideas. (Thurston, 1995, p.34)

What mathematicians most wanted and needed from me was to learn my ways of thinking, and not in fact to learn my proof of the general geometrisation conjecture for Haken manifolds. (Thurston, 1995, p.37)

The product *proof* is defined as explaining why a property holds within a theory, that is linking propositions according to the rules of logical consequence. "Theorems are the headlines, proofs are the inside story" (Rav, 1999, p.22). And it is believed that the definition of proof has to take into account the audience to whom it refers.

It became dramatically clear how much proofs depend on the audience. We prove things in a social context and address them to a certain audience. Parts of this proof I could communicate in two minutes to the topologists, but the analysts would need an hour lecture before they would begin to understand it. [...] And there were many other parts of the proof which should take two minutes in the abstract, but that none of the audience at the time had the mental infrastructure to get in less than an hour. (Thurston, 1995, p.36)

As Rav (1999) says, when considering the process of entering the relationship *B follows from A*, if you are

explaining the structure of the argument to a student or non-specialist, the other may still fail to see why, for instance  $A_1$  ought to follow from A. So again we interpolate  $A \rightarrow A'$ ,  $A' \rightarrow A_1 \dots$  (p.14)

until the subjects involved are satisfied with the explanation.

---

## 2.7 SUMMARY

The discussion of the literature presented in this chapter has highlighted some key issues, which form the basis for the rationale of this research project.

The historical and epistemological studies have shown that the role of proof has been, and still is, crucial in mathematics. Therefore, it is appropriate that students encounter proving in their mathematical activities and mathematics education researchers advocate that proof should be part of school curricula, even if in some countries it was abandoned for a while. It was also shown that the notion of proof is not absolute, but has a history and it is time and context dependent. Linking the notion of proof to deductive reasoning cannot be taken for granted and the aim of proof is not only to convince, but also to explain why, to understand, to discover, to communicate. This implies that when introducing proof in the classroom, teachers need to underline the appropriate function of proof according to the context they are working in.

The relationship between exploring, conjecturing and proving was discussed. It emerged that, when engaged in proving, the practice of mathematicians is different from what appears to the public by means of journals and various publications. Not only formal aspects are involved but also other things, for example the semantic content is always there. "An orientation towards extreme formalism in proof is not reflective of current mathematical practice or current philosophies of mathematics" (Hanna, 1989, p.22). Exploring, conjecturing and proving are connected and part of the same activity. Both the process of construction of a proof and the final product, as the object proof, should be taken into account, when investigating students' behaviour related to proving. This led to the definition of *proving process*.

Given the importance of proof in mathematics and the need to teach it in school, the teaching and learning point of view was explored, with particular attention to the difficulties teachers and students face when working with proving (concentrating on secondary school level students). The major difficulties highlighted by studies on students' construction and understanding of proofs are represented by the coexistence of formal and intuitive aspects, which materialise for example in the transitions from empirical to theoretical practices, from intuition to deduction, etc. Some researchers have stressed the existence of a hierarchy between different forms of proofs constructed by students, towards what is called proof in mathematics. Some other researchers have underlined the existence of a break between informal and formal productions. A third strand underlines that all

---

cognitive processes and ways of reasoning are important in the construction of a proof and there is not a hierarchy but an interplay among all of them. This interplay may then be a powerful means to be exploited in supporting students toward the construction of proofs, starting from their productions and activities.

Cognitive frameworks interpreting students' difficulties and suggesting ways of tackling them were presented. In particular a number of successful teaching experiments involving students approaching proving, and more generally theoretical thinking, were discussed. The main points emerging from these researches are: the fact that social interaction is considered as an important means to support students' construction of proofs and the fact that there may be a *cognitive unity* between the process of construction of conjectures and the process of construction of proofs.

To conclude, although proof is a fundamental concept in mathematics, the difficulties students encounter when approaching this concept are relevant, as shown by the research mentioned in the chapter. Therefore there is evident need for supporting students in their approach to proving. Possible ways of doing this have to be identified. This can happen through the investigation of the development of students' *proving processes*, from exploring to conjecturing to proving. The next chapter will introduce the perspective of the use of tools in mathematics, leading the reader into the choice of a possible way of supporting students in their approach to proving: the use of new technologies in the proving process.

## CHAPTER 3. NEW TECHNOLOGIES IN MATHEMATICS EDUCATION

*Much more fundamental change is possible: the computer, as we shall see, not only affords us a particularly sharp picture of mathematical meaning-making; it can also shape and remould the mathematical knowledge and activity on view.*

*(Noss & Hoyles, 1996, p.5)*

### 3.1 INTRODUCTION

Given the background on proof and proving presented in chapter 2, which highlighted the major difficulties students find when attempting to prove, this chapter will take into consideration the possibilities of using new technologies as tools to support students with respect to these difficulties.

Nowadays, new technological tools are widespread in most classrooms. However they are not always fully exploited by teachers and students. Understanding the potentialities of new technologies and the way they can modify and re-shape the teaching and learning processes both at a macro (institutional and didactical) and a micro (cognitive) level seems one of the main concerns of current educational research in many different subjects. These issues are tackled from different perspectives. From the didactical point of view, the role of technology in school curricula is being widely discussed in the debate, currently pursued in many countries, aimed at the development of curricular reforms (see e.g. CREM, 1995; AAVV, 2000; Abrantes, 2001; Robutti, 2001). Studies about how new technologies can be integrated in classroom practice have been carried out and teaching experiments are tried out to explore different possibilities. These studies are based on research about how the



---

introduction of new technologies changes learning in the classroom. Such research focuses either on the effects of technologies on specific learning processes (see e.g. Laborde, 1998; Hoyles & Healy, 1999; Sutherland & Balacheff, 1999; Healy, 2000b) or on the impact technologies have at the level of classroom interactions (see e.g. Laborde, 1993; Artigue, 1997; Bartolini Bussi & Mariotti, 1998; Winbourne, Barton, Clark, & Shorter, 2001).

The main issues that are discussed across all studies are:

- the effects of the use of particular technologies on specific learning processes;
- the role and function new technologies should have in the classroom and in mathematics curricula;
- the way new technologies should be integrated into classroom practice.

This chapter provides a discussion of the impact of new technologies in mathematics education, mainly dealing with the first point, which forms the basis for the discussion of the other two points. It will focus in particular on the impact of one particular piece of technology (dynamic geometry software) with respect to proving.

The chapter has three main sections. First, theoretical frameworks concerning the introduction of new technologies in the teaching and learning processes are discussed. Second, the specific role of computers in the processes of interaction taking place when students have to work on a common task is introduced. Finally, a specific tool, a dynamic geometry software, is presented and different research studies are discussed, with particular respect to the impact on the proving process.

### **3.2 WORKING AND INTERACTING *WITH* NEW TECHNOLOGIES**

The issue of the use of new technologies in relation to the teaching and learning of mathematics has been tackled by many researchers from different perspectives, which reveal the complexity of the issue and cannot be easily unified.

Information technologies, from television to computer and all their combinations, open unprecedented opportunities for action on improving the quality of the learning environment, by which I mean the whole set of conditions that contribute to shaping learning in work, in school and in play. (Papert, 1992, p.IX)

This initial enthusiasm has been reconsidered by a number of studies which show that focusing on the potentialities of new technologies in the classroom is not sufficient, as “the presence of the computer does not always produce what is expected” (Mariotti, 2002, p.698). Therefore there is a need to understand better the interactions between new technologies and their users, which includes both students and teacher.

Vygotsky (1978) defined the notion of *mediated act*, saying that mediation is the characteristic that allows humans to go beyond simple stimulus-response reflexes. He stated that humans make indirect links between incoming stimulus and the resulting responses through mediating links, which allow them to analyse human psychological functions as complex, mediated acts, as represented in Figure 3.1.

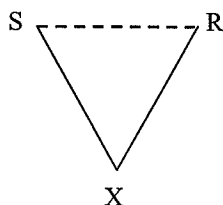

Figure 3.1. Mediated act (Vygotsky, 1978)

Broadly speaking, this project shares the socio-cultural perspective as far as the use of tools is concerned. The focus is on examining agent and tools as they interact. Any attempt to reduce the account to one of them only will destroy the phenomenon under observation (Wertsch, 1998). In developing his claims about issues such as the development of thinking and speech, Vygotsky insisted on the need to focus on *units*, which possess all the basic characteristics of the whole (Vygotsky, 1987), rather than on *elements* of analysis. To recognise the irreducible tension between agent and tools means to conceptualise the interaction as a system characterised by dynamic tension among various elements (Wertsch, 1998).

This section will deal with issues concerning the unit pupils-new technologies, focusing on ways of interactions and how these interactions may affect learning processes.

### 3.2.1 Microworlds

Within the constructivist approach to learning, based on the idea of knowing as an “adaptive function” (von Glasersfeld, 1991), the idea of *microworld* was introduced starting from the seminal idea of Papert (1980). “At the core of a microworld was a knowledge domain to be investigated by interaction with the software” (Hoyles, 1993, p.3). So microworlds provided environments for solving problems in which pupils could experience the constraints of the underlying mathematical system and in so doing construct their own mathematical system (Hoyles, 1993). It was believed that “a microworld offers a great learning potential; its very nature, characterized (sic) by the availability of computational objects and the interactive processes occurring within it, plays a basic role in the users’ construction of meanings” (Mariotti, 2002, p.700). There are two complementary aspects

---

relating to the use of microworlds (Mariotti, 2002). On the one hand mathematical ideas, as incorporated in microworlds, have got a concreteness which makes them manipulable and on the other hand meanings may emerge from abstraction processes, based on the interactions between the students and the microworld. However, the solutions students may produce by working within a microworld may strictly relate to the particular microworld they interacted with and as such be “situated abstractions” (Hoyles, 1993). On the other hand, the interaction with the objects of the microworld of the kind “touch and see” (Yerushalmy, 1997) may require an interpretation of the phenomena observed in the environment, which has an internal logic. All these issues imply that the interaction of pupils with microworlds embodies some difficulties.

### 3.2.2 Amplifiers or reorganisers?

The processes of interaction of students with computers are much more complex and do not always lead to the production of the expected meanings. The distinction between computers as amplifiers and reorganisers proposed by Pea (1987) may be useful to interpret this. Usually, technologies are mainly seen as “*cultural amplifiers*” of the intellect, such as tools that can improve human cognitive capacities. However, even if it is true that they allow more speed and efficiency of learning in problem-solving activities, we cannot stop at this level. Pea shares another point of view that goes beyond the narrow metaphor of the cultural amplifiers, which does not describe all the meaningful changes the introduction of cognitive technologies implies. Since by creating new instruments to act on nature in a less direct way we restructure our human nature, therefore “using different instruments of work changes the functional organization (sic) of the human relationship to work” (Pea, 1987, p.93). It is not only the fact that the work is finished more quickly, but also the fact that you need a change in the actions required to achieve the task itself. According to this view, cognitive technologies are not only amplifiers, but also “*reorganisers*”. Another implication of the term amplify is that it refers specifically “to the intensification of a signal, which does not undergo change in its basic structure” (p.94). The common image of the effect of computers on mental processes is one-directional: a child sitting in front of a computer and reacting according to the inputs given by the machine. However, if we carefully analyse the impact of technologies, we shall agree with the fact that they do not simply amplify the mental power of a learner, given that they imply a restructuring of the thinking activities. Pea gives a two-directional interpretation of the cognitive effects of computers: not only computers affect people, but people affect computers. First of all, because we interpret what computers do and we design suitable activities to be carried on with them; secondly, as we

study their use and try to change them in a way that satisfies our requirements in terms of educational aims and goals.

The basic question he addresses is how the idea of cognitive technologies does relate to mathematics education, i.e. what aspects of mathematical thinking can be “catalyzed” (sic) by the use of new technologies, and in which way they can reorganise cognitive processes. Pea (1987) lists some “transcendent functions”, such as aspects of cognitive technologies that can promote learning and thinking mathematically.

Although I take for granted the utility and power of these types of tools in the hands of a person committed to problem solving, their usefulness stems in part from the extent to which they incorporate the purpose and process functions.... In other words, the intrinsic value of such tools in helping students to think mathematically is not a given. (p.99)

There are two kinds of functions directly related to students: first, students are goal directed learners who have the will to learn mathematics or not; therefore we need purpose functions that can support the students’ engagement in the learning process. Then, once they have started, they need help to support the process itself; so we need also process functions, promoting aid to the students. The key point is that cognitive tools should allow the learner to become an “agent”, such as a subject actively engaged in mathematical thinking. As a consequence of these issues, purpose functions should necessarily be incorporated into cognitive tools, as they can help the learner become a “thinking subject” or a “mathematical agent”.

### **3.2.3 The instrumental approach**

If new technologies are seen as “reorganisers” then the process of ‘reorganisation’ needs to be studied. Comments like “students’ reactions and reflections did not have the meaning that the teacher expected” (Lagrange, 1999, p.194) are common findings in the current research on the use of new technologies. The instrumental approach elaborated by Verillion & Rabardel (1995) provides a new perspective on the effect of technical devices<sup>1</sup> on learning processes (e.g. computer or microworld) and may explain why these things happen.

According to the instrumental approach, any technical device has a double interpretation: on the one hand it has been constructed according to a specific knowledge which assures the accomplishment of specific goals, and on the other hand, there is a user who makes his/her own use of the device. In other terms, in this perspective it is important to highlight

---

<sup>1</sup> This approach considers the use of tools in generals, not necessarily new technologies.

the distinction between *artefact*, which is "the particular object with its intrinsic characteristics, designed and realised for the purpose of accomplishing a particular task" and *instrument*, that is "the artefact and the modalities of its use, as elaborated by a particular user" (Mariotti, 2002, p.702). The notion of artefact can be related to the notion of affordance (Gibson, 1979), as referring to the perceived and actual properties of a thing, primarily those functional properties that determine just how the things could possibly be used. The ways in which the artefact is actually used, according to the instrumental approach, are *personal schemes of use*. "For a given individual, the artefact at the outset, does not have an instrumental value. It becomes an instrument through a process, or genesis, by the construction of personal schemes" (Artigue, 2001, p.4), or schemes of use, which function as organisers of the activity of the user. As different and co-ordinated schemes of use are successively elaborated, the relationship between user and artefact evolves, in a process called *instrumental genesis* (Figure 3.2). Therefore an instrument is an internal construction and its development is a long-term process. At different moments different instruments can exist even if the artefact used is the same.

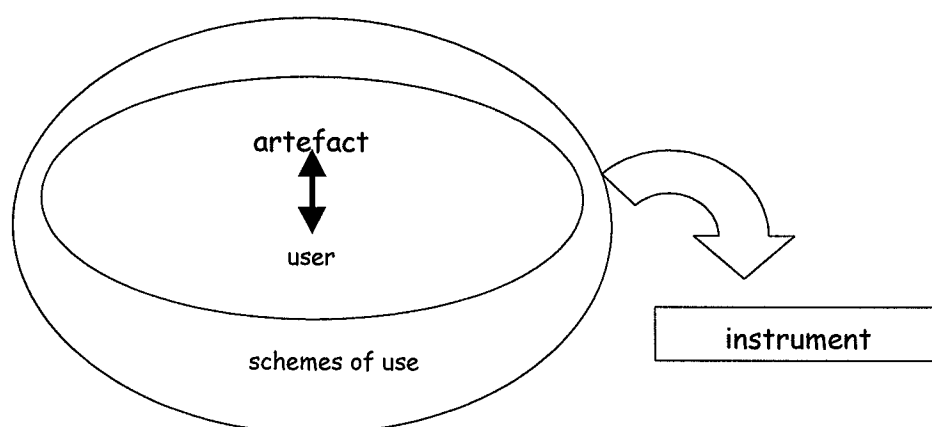

Figure 3.2. The instrumental genesis (Verillion & Rabardel, 1995)

In the process of instrumental genesis students construct meanings from the activity they carry out with the tool. However, there is no guarantee that the meanings constructed are the useful ones directed towards the solution of the given problem.

Meanings are rooted in the phenomenological experience (actions of the user and feedback of the environment, of which the artefact is a component) but their evolution is achieved by means of social construction in the classroom, under the guidance of the teacher. (Mariotti, 2002, p.708)

### 3.2.4 Semiotic mediation

Another dimension that needs to be added to the picture is the social dimension. The teacher plays a fundamental role in directing the students towards the construction of the appropriate instruments starting from the same artefact.

Mariotti (2002) deals with this issue, relating the instrumentalisation process to the Vygotskian notion of semiotic mediation (Vygotsky, 1978). Vygotsky distinguishes between *technical tools* and *psychological tools* (or *signs*). The difference between these tools concerns "the different way they orient the human behaviour" (Vygotsky, 1978, p.54). Technical tools are externally oriented and their purpose is to serve as the conductor of human activity aimed at mastering nature. Psychological tools are internally oriented aimed at mastering the self. The process of *internalisation* described by Vygotsky may transform technical tools into psychological tools, when an externally oriented tool becomes a psychological tool and shapes new meanings<sup>2</sup>. In this sense a tool may function as a *semiotic mediator* (Mariotti, 2002). Internalising means reproducing internally something that has been done externally (e.g. an action). The process of instrumental genesis only accounts for part of this internalisation process and therefore the analysis of the functioning of artefacts must be further elaborated (Mariotti, 2002). On the one hand, through the process of instrumental genesis, the artefact can evolve into an instrument, that is an artefact that is used according to personal schemes, for example by students. On the other hand, the artefact can act as a semiotic mediator, given that some theoretical knowledge is embedded in an artefact and therefore this can be used in order to construct knowledge, for example by the teacher. As a consequence, the artefact appears to be between learners and teachers: learners use it in order to accomplish a task while teachers use it in another way, in order to make it work as a semiotic mediator, that is towards the construction of meanings.

### 3.3 INTERACTING AT NEW TECHNOLOGIES<sup>3</sup>

Mariotti (2002) stressed the role of the teacher in guiding the students towards the construction of the appropriate instrument for a given situation. What about the role of the other students in the classroom? The instrumentation process may lead to the construction of different instruments for different people using the same artefact. So how can students then communicate and share their understanding?

---

<sup>2</sup> "An interpersonal process is transformed into an intrapersonal one. Every function in the child's cultural development appears twice: first, on the social level, and later, on the individual level; first *between* people (*interpsychological*), and then *inside* the child (*intrapsychological*). This applies equally to voluntary attention, to logical memory, and to the formation of concepts. All the higher functions originate as actual relations between human individuals" (Vygotsky, 1978, p.57).

<sup>3</sup> The phrase "interacting at" new technologies is taken from Crook (1994). "By that, I mean circumstances in which small groups of children (as it happens, usually pairs of children) are organised to work on the same computer-base problem at the same time." (p.148)

---

A number of studies deal with issues relating to the interactions between subjects working together both with and without computers. When two students work together on the same problem, it must not be taken for granted that they can automatically communicate and really 'work together'. "The process of collaborative learning is not homogeneous or predictable, and does not necessarily occur simply by putting two students together" (Teasley & Roschelle, 1993, p.253). Individuals must make a continuous effort to coordinate their language and activity with respect to shared knowledge. Trognon (1993) has pointed out that even if two people are listening to each other, it may be the case that they do not understand each other. Therefore it is important to see when communication and understanding happen and how. This section will discuss in particular the role of the computer in fostering (or not) the communication between two students working on a task together.

### **3.3.1 Entering another's universe of thought**

Kieran & Dreyfus (1998) introduce the idea of "*universe of thought*" (p.112) taken from Trognon (1993, p.341), in order to account for how and when students understand each other. They identified five types of interactions in the talk of a pair of 13-year-old students solving an algebra problem together in paper and pencil, according to how their universes of thought interact.

*Pragmatic interaction*: "Students' interaction does not reflect their thinking. Each one appears to be contemplating the problem for himself, in his own way, within his own universe; when trying to convince the other, however, they do not use reasoning but simple statements" (p.115). There is interaction but no communication. The superficiality of the interaction may be due to the fact that their universes of thought are incompatible.

*Homogeneous interaction*: "When two people think alike, in overlapping parts of their respective universes, they can often work together quite well" (p.115).

*Pseudo-interaction*: even if students take turns in talking, they hardly listen to each other, each one works "by himself on a separate line of thought, within his own universe and talking more to himself than to the other" (p.116). There is no interaction going on at all.

*Inhomogeneous interaction*: the students "efficiently collaborate to find a solution, each providing what he is best at"; "each participant presents his own thinking in spite of

being conscious that the other finds it difficult to follow" and "the basis for the interaction is constituted by differences in the students' universe" (p.117).

*Anti-interaction*: when the students refuse to interact. "Most people, when learning mathematics, need some extended periods of quiet concentrated thought by themselves" (p.117).

They conclude that "the moments in which one truly enters the universe of thought of the other may be quite brief but they play a fundamental role" (Kieran & Dreyfus, 1998, p.112).

An idea similar to the *universe of thought* is shared by Noss & Hoyles (1996):

We start from the premises that each individual has a complex set of understandings of the idea of proportionality, and that any learning situation should aim to set in motion the reconnection of these understandings with each other, and with new understanding derived from interaction in the situation. (p.77)

On the same line of thought is Crook (1994) who observes that it has been shown that what successful collaborators are more likely to refer to when talking about their work, is "the feeling of working towards constructing an object of joint understanding - something that comes to exist between them as a cognitive resource" (p.151).

### **3.3.2 The role of the computer in constructing shared knowledge in students' interactions**

Teasley & Roschelle (1993) investigated the construction of shared knowledge in collaborative problem-solving in a computational context involving model-building activities (Envision Machine). They introduce the idea of "*Joint Problem Space (JPS)*", which

is a shared knowledge structure that supports problem solving activity by integrating (a) goals, (b) description of the current problem state, (c) awareness of available problem solving actions, and (d) associations that relate goals, features of the current problem state and available actions. We propose that the fundamental activity in collaborative problem solving occurs with an emergent, socially negotiated set of knowledge elements that constitute a Joint Problem Space (p.236).

Understanding how the social interactions affect the course of learning requires "understanding how students use coordinated language and action to establish shared knowledge, to recognize (sic) any divergences from shared knowledge as they arise, and to rectify misunderstandings that impede joint work" (p.235). Teasley & Roschelle (1993) want "to describe how the communicative exchanges function to construct and maintain a JPS" (p.235). They take the point of view that students' work is based on a shared conception of the task. "Collaboration is a coordinated, synchronous activity that is the



---

result of a continued attempt to construct and maintain a shared conception of a problem" (p.235).

Collaborative problem solving consists of two concurrent activities, solving the problem together and building a JPS. These activities necessarily coexist. Conversation in the context of problem solving activity is the process by which collaborators construct and maintain a JPS. Simultaneously, the JPS is the structure that enables meaningful conversation about problem solving to occur. (p.236)

The JPS is a pragmatic, rather than an ideal structure. The overlap of meaning in the collaborators' common conception of the problem is sufficient to "gradually accumulate shared concepts and allow convergence on certainty of meaning" (p.236). This means that to build a JPS, collaborators must have ways of "introducing and accepting knowledge into the JPS, monitoring ongoing activity for evidence of divergences in meaning, and repairing divergences that impede the progress of collaboration" (p.236). They identified different structured forms of discourse used towards the construction of a JPS.

*Turn-taking.* "The ongoing structure of turn-taking sequences is an indication of the degree to which students share common problem representations" (p.237). There may be moments in which there is no interaction and the two people carry on individual activity. After that there is usually a period of intense interaction, in which the individual insight must be incorporated into the shared problem solving knowledge.

*Socially-Distributed productions:* "One partner's turn begins a sentence or an idea, and the other partner uses their next turn to complete it" (p.237).

*Repairs.* "Both partners use justifications, counter-suggestions, assertions, and elaborations in their attempt to get their partner coordinated." (p.237) Occasionally this may not happen. This can be seen when the partners give up a challenge and may return to it later in the process.

*Narrations.* "They are a verbal strategy that enable partners to monitor each other's actions and interpretations." (p.238). In the Envision Machine activity, only one partner can carry out actions with the mouse at a time. These actions may be difficult for the other partner to interpret, because every action can correspond to a number of possible intentions. Narration informs one's partner of the intentions corresponding to actions. This enhances the partner's opportunities to recognise differences in the shared understanding. Continued attention to narration and accompanying action can signal acceptances and shared understandings (Clark & Schaefer, 1989). Interruptions to narrations create an immediate opportunity to rectify misunderstandings. Narrations are also useful for the participants to signal that an action is not intended to contribute to

the current shared goal; a statement like 'I just want to see what this does' signals that the actor is no longer working on the task at hand, but rather is exploring a novel situation.

In particular, Teasley & Roschelle (1993) found that the computer supported collaborative learning as a resource that mediates collaboration. How do resources provided by the computer support collaboration? According to Teasley & Roschelle (1993), "students are not wholly dependent on language to maintain shared understanding. In fact, one major role of the computer in supporting collaborative learning is providing a context for the production of action and gestures" (p.238). They both serve as presentations and acceptance.

Partners often use their hand or the computer mouse to demonstrate an idea. ... The simultaneous production of matching language and action by separate partners can also produce an effective division of labour: while one partner concentrates on carrying out actions, the other concentrates on producing utterances that make the intentions behind the actions available for commentary and repair. (p.239)

Second, the computer had the role of "disambiguating language" (p.254) and actions with the mouse could be interpreted as nonlinguistic ways of presenting ideas or showing agreement. Third, the computer was used to overcome impasses, by trying out ideas and looking at the outcome. Finally, the computer was a device that invited and constrained students' interpretations. "Computers can enable students to use the powerful resources of everyday conversation to converge on robust shared meanings for technical concepts" (p.255).

Similar issues are raised by Noss & Hoyles (1996):

The software as a mediator of social interaction, not so much as a way of constraining the action, but as a medium through which shared mathematical expression can be constructed and - critically - observed. From this perspective, the nature of the software is not just an important variable; it is crucial, for two reasons. First, it must provide a means by which students can build their own problem space. [...]. Second, it must have the capability to serve a communicative function through which meanings can be made explicit and open to negotiation. (p.142)

By offering a screen on which students can express aspirations and ideas, "the computer can help to make explicit what is implicit, it can draw attention to what is often left unnoticed" (Noss & Hoyles, 1996, p.5). They take into account the mediating role of the computer. In a transmittal view of learning or in a constructivist perspective, the problem is how to help B know what A knows.

A wants B to know what A knows. The normal process is  $A \rightarrow B$ . Let us for the moment assume that we have a rather special kind of computer, one on which B can express what he or she knows. Already A has some insight into the state of B's understandings, the meanings which are evoked for B by the problem or the situation. What is more, A has now a language with which to interact with B, the language of action in which ideas on the computer are expressed. [...] A and B both have a

---

two-way channel of communication with the computer, and in establishing these channels, it (actually the setting) has opened a channel from B to A where previously the direction of communication was essentially one-way (from A to B). (p.5-6)

What has the computer brought to the situation? It brought an

enhanced communication between people; [...] an arena in which A and B's understandings can be externalised; not a means of displaying A's knowledge for B to see, but a setting in which the emerging knowledge of both can be expressed, changed and explored. The language that A and B can now use to communicate is the language of the medium. (p.6)

Crook (1994) describes certain computer-based interactions that he observed in primary school classrooms, where children were asked to work in groups on the same computer-based problem at the same time.

On the one hand, I am suggesting that attention to peer interactions around computers is especially helpful for our efforts at conceptualising the nature of collaboration very generally. On the other hand, I am framing an account of collaborative interactions that has particular implications for how we might best design and deploy computers within classroom life. (p.149)

He explores the dynamics of shared knowledge during collaborative computer work: how partners invest in its creation, what form that creation takes, and how it can be exploited as a platform for reasoning. He identifies the structure of "*shared reference*" (p.187) as central for what participants want to achieve within joint problem solving. "The trick to successfully supporting much collaborative work in classrooms may involve confronting pupils with abstract material within concrete and manipulable representational forms" (Crook, 1994, p.187). Bennet (1991) found that young pupils do not collaborate easily around abstract material such as that encountered in mathematics; but they are quite forthcoming in situations that offer more exploratory possibilities. "It seems as if, given the opportunity to talk about action, the children will take it" (Bennet, 1991, p.591). Crook (1994) states that "often computers may turn out to be a special resource for creating such opportunities" and in particular the computer manipulable representations can be important "in supporting shared reference among pupils themselves - as they collaborate [...] and the important challenge is to determine when and how the creation of shared understanding is embedded in these lively interactions" (Crook, 1994, p.188).

In a three year project named *Groupwork with Computers*, Healy, Pozzi & Hoyles (1995) observed groups of six students working in different mathematical contexts in computer and paper and pencil settings, out of the classroom. Three computers were made available in each group. One of the objectives of the project was to identify the links between task, content, software, group processes and students' mathematical learning. As a first result, the project showed that "any suggestions that 'groups are good' is not well-founded" (p.150). The most significant finding is that

effective learning of conceptually based material involving the appropriation of mathematical relationships occurred when there was a synergy of interdependence and autonomy through active construction at the computer which fed into wider group discussion - whether the individual was a vocal or non-vocal participant in that discussion or not. (p.150)

Two styles of interaction among the participants of the groups were identified: "integrated" and "fragmented" groups. "Integrated groups" showed a maintained communication among subgroups during local and global tasks; at the same time, cross-computer activity, in which the students looked at each other's screens, was evident. On the contrary, "fragmented groups" became focused on their own work and the communication was minimal except through action; there was a low level of cross-computer activity.

The computer gave them [the students working in an integrated style] a medium for talking about what they had constructed, comparing their constructions, and refining their conclusions by articulating and reflecting upon their own and each other's strategies. Students working in the integrated style, jointly breathed life into a web of meanings that spanned across their collective and individual constructions. (p.151)

### 3.4 THE CASE OF DYNAMIC GEOMETRY SOFTWARE<sup>4</sup>

The studies about the teaching and learning of proof discussed in chapter 2 showed that students find many difficulties in approaching proof. Identifying new tools in order to support students in proving activities seems to need further research. The potentialities of multimedia environments (such as computers) are currently under discussion according to many different perspectives, including the teaching and learning of proof. This research focuses in particular on the potentialities of dynamic geometry software (Cabri-Géomètre) with respect to this issue. In fact, new issues about the role of proof arise when new technologies are taken into account and this type of software is introduced into school practice (Hanna, 1996).

Cabri-Géomètre<sup>5</sup> (Baulac, Bellemain, & Laborde, 1988) consists of an environment for constructing and manipulating figures in the context of Euclidean geometry. Cabri contains primitives for drawing the fundamental objects of geometry (e.g. point, line, circle, segment) and geometrical primitives, such as commands which allow the user to construct new geometrical objects starting from the fundamental ones (e.g. perpendicular line, parallel line, angle bisector). The most relevant feature is the dragging function, that is the possibility of directly moving<sup>6</sup> and manipulating the constructed figures on the screen: if a

---

<sup>4</sup> This project used the software Cabri-Géomètre, however the issues discussed in this section apply more generally to any kind of dynamic geometry software.

<sup>5</sup> This study used Cabri-Géomètre II.

<sup>6</sup> The idea of movement in geometry is not new, since Greek geometers had already devised procedures to draw mechanic curves. However, the intervention of movement at that time was banned from geometrical reasoning because of

---

figure has been correctly drawn, according to the rules and properties of geometry, it keeps all its internal relationships whenever it undertakes dragging. Otherwise it messes up (Healy, Hölzl, Hoyles, & Noss, 1994b).

A number of different research approaches can be identified in the literature about Cabri, from more technical to more didactical<sup>7</sup>. Technical studies focus on *what* Cabri allows you to do, which paper and pencil did not, i.e. on the software itself. Cognitive and didactical studies centre on *how* Cabri allows you to do different things from paper and pencil. As far as this research is concerned, there are a number of important issues which have been addressed by recent studies regarding Cabri, such as: the use of dragging, the interplay between empirical and theoretical properties linked to Cabri objects, the use of Cabri for conjecturing and eventually proving. The following sections will discuss these issues, with particular respect to the link with proving, and present some examples of successful use of Cabri with respect to those issues.

### 3.4.1 Dragging in Cabri

Having a set of movable points gives students new material to observe, which they do not have in paper and pencil. The kind of geometry you can do with this type of software is referred to as dynamic geometry. However this term could possibly have a broader meaning, not only related to the experimentation rendered possible by this software. Hölzl (1996) talks instead about a *Cabri-geometry*. Even if at first sight dragging is not a new construction tool, and so it should not alter Euclidean geometry, implementing dragging requires the users to start from different assumptions and to perform different operations on the objects. This has much to do with the problem of establishing which are the

---

metaphysical reasons. In the 17<sup>th</sup> century the Greek tradition was broken and movement was used as a way to establish a geometrical property or to do a geometrical construction. Many examples can be found from this century onwards, as for example the cinematic generation of the ellipse attributed to La Hire and the ideal mechanism to draw algebraic curves due to Descartes, which is presented below. While the ray  $r$  rotates, points A, B, C trace algebraic curves of degree 2 (circle), 4 and 6, as we can see in the following figure.

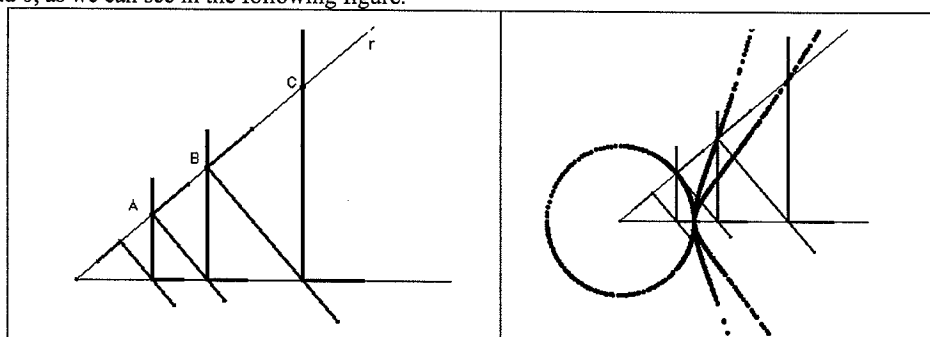

<sup>7</sup> The website [www.cabri.net](http://www.cabri.net) provides an entry into different ways of using Cabri.

characteristics of geometry: the body of axioms, the proven theorems or the operations you can do with them? Or should we need to consider also the new available tools and the actions users carry out? The dragging function suggests new ways of reasoning and operating, which are typical of the so-called *Cabri geometry*. Apparently, it was supposed to be just a tool for exploring the various invariant relationships inherent in a geometric construction. However the "drag-mode alters the relational character of geometric objects" (Hölzl, 1996, p.171). This statement is supported by an example. If one constructs an equilateral triangle ABC in which points A and B are given, then C cannot be dragged whereas A and B can. From a *relational* point of view there is no need to distinguish the points A, B and C, as each pair of them determines the original equilateral triangle. From a *functional* viewpoint (essentially Cabri) the situation looks different: *A and B* determine the position of C but in return C does not determine the position of A and B.

So Cabri does not permit one to drag constructed points; a distinction arises between 'dragable' and 'non-dragable' points. This distinction may be 'ungeometrical' and totally unknown (because unnecessary) in a paper and pencil environment but is nevertheless important for pupils working in dynamic geometry. (Hölzl, 1996, p.172)

**Dragging as feedback.** Some research has seen dragging as a feedback to students' activity. As far as construction problems are concerned, dragging allows students to have the control, within Cabri, of the correctness of the construction according to the requested properties: dragging hinders the evolution of geometric construction problems from practical to theoretical problems, thanks to the dragging test<sup>8</sup> (Mariotti, 1996). This powerful feature provides the student with strong evidence that the theorem is true (Hanna, 1996), therefore it offers a feedback to the process of discovering within exploration tasks.

**Dragging as a mediator between drawing and figure.** Other research has shown that dragging is a mediator between the concepts of *drawing* and *figure*. A drawing in Cabri represents a geometrical object, which has internal structure and rules and which can be transformed into another instance through the dragging function; figures are the geometrical invariants as opposed to the variation of the drawing, provided that the movement preserves the invariants within the geometry considered. The dragging test can be used to recognise the difference between drawings and constructions (Healy, Hölzl, Hoyles, & Noss, 1994a).

---

<sup>8</sup> A construction passes the dragging test if, when moved, it keeps all the geometrical properties the construction was based on. For example, a square passes the dragging test if, when dragged, it stays a square, i.e. it has been constructed with four perpendicular and equal sides.

---

**Dragging as a test mode or as a search mode.** Hölzl (2001) suggests that the dragging function can be used in two ways: drag mode as a test mode or drag mode as a search mode. The first mode “presupposes an expectation as to the reaction of the drawing when it is being dragged. The movements on the screen can meet the expectation or not” (p.83). In the second mode “the changing appearance of the drawing must be evaluated under aspects which are still unknown. The task is to recognise the invariants of the figure and this means precisely to recognise what is *not* changing” (p.83). He suggests an evolution of dragging over a period of time. In a two-year research project he observed that an appreciation of the dragging function was developed by the students in the long term. As a first step the students viewed dragging as a graphic tool with which to change the appearance of the drawings. The drawings were looked at as “mechanical models” (p.83). The focus was on the way figures moved. Then, the students learnt to use dragging in order to check conjectures. Still they used dragging in order “to explore the movement properties of a drawing rather than the relational properties of a figure” (p.84). He suggests we need to find ways “to help students focus on invariants rather than focus on details which suppress the overall impression of a drawing in its concentration on local relationships between parts of a figure.” (p.84)

This review shows a phenomenological analysis of dragging, that is an analysis of dragging as such, from the outside, without taking into account how the subject who is using dragging interprets it. Goldenberg & Cuoco (1998) on the contrary start considering the point of view of the subject: how a displayed movement is perceived may depend on the context in which it is set. They provide an example in order to unpack this hypothesis. Consider a segment AB (Figure 3.3). When this is the only object present on the screen, as the user moves it through A, he perceives the movement as a *translation* of the point. The display may also tend to be seen more as a mapping of A (in its various positions) to C (the midpoint of AB), than as a mapping of A and C to A' and C' respectively. But other situations may lead to very different perceptions. For example if we add a line perpendicular to AB at B, now the movement of A is more likely to be perceived as a *rotation* of the entire system, the feeling of a translation is less evident. What do students make out of this?

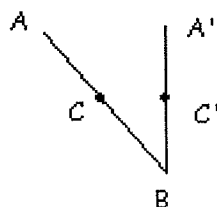

Figure 3.3. What do students make out of this? (Goldenberg & Cuoco, 1998)

### 3.4.2 Spatio-graphical field and theoretical field in Cabri

The role of diagrams in geometry is often the cause of problems for students. Diagrams in 2D play an ambiguous role, because on the one hand they refer to theoretical objects but on the other hand they offer graphical-spatial properties which can stimulate an empirical-perceptual activity from the subject dealing with them (Laborde, 1998). When dealing with geometry problems, students always find difficulty in distinguishing between what you are allowed to read from diagrams and say, what you are allowed to read from diagrams without saying and what you are not allowed to read from diagrams (Arsac, 1999a).

When working with a diagram, spatio-graphical properties need to be distinguished from theoretical properties; therefore Laborde (in print) introduces a distinction between

the domain of geometrical objects and relations (denoted by T, it refers to *theoretical*) and the domain of spatio-graphical entities (denoted by SG, SG refers to *spatial-graphical*). [...] T refers to theoretical objects, relations and operations on these objects as well as judgements about them, that is possible to express in various languages. SG denotes the level of the graphical entities on which it is possible to perform physical actions, and also to express ideas, interpretations, opinions, judgements (p.4).

When students are asked to deal with a geometrical problem, usually teachers expect an answer belonging to the theoretical domain and produced by using elements belonging to the theoretical domain (for example the answer required from a problem asking to prove some properties is expected to be a deductive reasoning making use of theoretical geometrical properties only). Teachers usually consider drawings, and other sources, as for example dynamic geometry software, auxiliary means but not to be referred to in the answer. However, the situation is more complex. Laborde (1997) claims that the solution of a geometry problem requires the use of both SG and T domains and is constituted by continuous moves between SG and T (Figure 3.4).



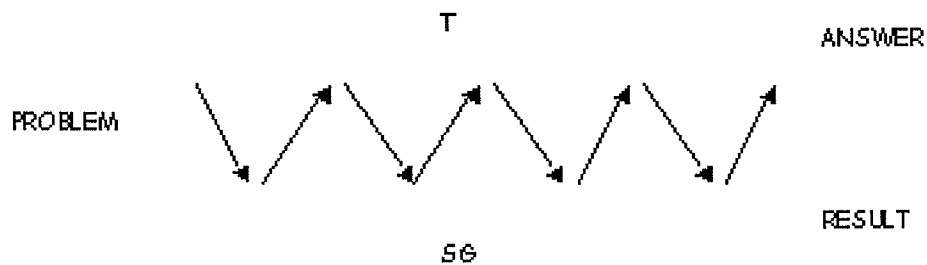

Figure 3.4. Moves between SG and T (Laborde, 1997)

In such a model, while solving a problem students work at three different levels: at a spatio-graphical level, when they observe spatio-graphical invariants (e.g. the shape of some objects, the coincidence of different objects, some invariance of the size of objects); at a theoretical level, when they use definitions and theorems; relating the spatio-graphical and the theoretical level, when there is an immediate interpretation of spatial phenomena in geometrical terms or when a geometrical reason for something observed about the behaviour of the diagram is found. Similar results are found by Bartolini Bussi (1993), when analysing students' work with mathematical mechanisms: they show "*experimental moves*" (based on actions on the mechanism and visual experiments) alternate with "*logical moves*" (including the production of statements deduced from other statements accepted as valid).

Cabri presents the learner with two worlds (Sutherland & Balacheff, 1999): a theoretical world, which is that of geometry, and a mechanical, manipulative world, which is the phenomenological domain of Cabri, that is part of the SG domain. Therefore, spatio-graphical and theoretical aspects are very much interrelated in the Cabri objects. "Cabri provides diagrams whose behaviour is controlled by the theory" (Laborde, in print). Cabri objects are part of a computer environment which can be considered 'half-world' (Noss & Hoyles, 1996, p.6) in between theory and practice. With this respect Cabri figures are a midway between empirical and generic objects. On the one hand, as empirical objects they can be manipulated and the effect of this manipulation can be seen on the screen as it happens. On the other hand, dragging figures in Cabri allows one "to see the one as a multitude, other than one among others" (Pimm, 1995, p.59) and see figures as generic objects. Also, Cabri figures "have an internal logic, which relates to their construction: the different parts of a Cabri figure are related to each other according to the way the figure was constructed" (Mariotti, 1996, p.271) and as such they embed theoretical elements.

Laborde (in print) observed students' solution processes in geometry tasks in Cabri as concerns the relationship between the SG and T domains, with particular attention to the different modalities students show in linking SG and T. The moves in the transition from SG and T are: interpretation of a spatio-graphical invariant in geometrical terms and geometrical justification for something observed in the behaviour of a diagram. The move from T to SG is: prediction about spatio-graphical objects based on geometrical knowledge.

The computer environment played a decisive role in the establishment of the links between SG and T. The computer not only enlarges the scope of both possible experimentation and visualisation but modifies the nature of the feedback. The feedback is visual on the surface but it is controlled by the theory underlying the environment. (Laborde, in print, p.17)

The main conclusions from Laborde (in print) are that the coexistence of spatio-graphical and theoretical elements in the Cabri objects is "a source of potential evolution of pupils in geometry" (p.23) and "back and forth moves between the spatio-graphical level and the theoretical level may play a crucial role" (p.23) in the solution processes to geometry tasks.

### 3.4.3 Cabri and proving

The use of dynamic geometry with respect to proving in mathematics is very controversial. This section presents different perspectives around the problem, as it is tackled in research. In general, some research sustains that since in Cabri you can 'see' whether a property holds or not, Cabri works against motivating students to construct proofs for what they discover, while an opposite view argues that dynamic geometry might be a way to promote students' understanding of the need for and the role of proof, as discussed below.

The role of Cabri as a support in conjecturing and testing conjectures compared to paper and pencil is shown by a number of researchers (e.g. Schumann, 1997; deVilliers, 1998; Hanna, 2000). As Noss (1995) observes,

My point is that *you need to have something to prove*. Computers now have the potential to enlarge the range of mathematical objects about which we can have intuitions and start to wonder, "*well, is this always true?*".... Software like Cabri-Géomètre and Logo can open doors of mathematics in ways that we could not have imagined young children could understand. (p.4)

Laborde (2001) reports that the teachers involved in producing scenarios for teaching which exploited the potentialities of Cabri, at the beginning used "the observation tasks in which Cabri facilitated the production of conjectures" (p.195), which was what struck them most. Some educators see the great potential of dynamic geometry software in exploration, as an argument in favour of the abolition of deductive proof in favour of an experimental approach to mathematical justification (Hanna, 2000). Some educators thought that dynamic geometry software celebrated the use of measures, against the need for proof (Chazan, 1993). According to some other researchers, the dynamic capabilities of this

---

software could put into question the need for analytical proof. They argue that the dragging feature provides students with strong evidence that a property or theorem is true, so that they will not be then motivated to find a proof for that property or theorem. For example Mason (1991) states

I predict that one of the long-term effects of computers will be to establish a mode of certainty which lies between the too-easy acceptance of a generalisation from one or two cases and the rigour of mathematical proof. Programs like Cabri-geometry enable the user to experience a huge range of particular cases, and by appeal to continuity, an infinite number of cases. This plethora of confirming instances will be highly convincing for many, if not most, people. I find this entirely reasonable. (p.87)

This perspective reflects the current tendency of interpreting the increasing use of computers in mathematics as a sign of the fact that proof no longer has a central role in mathematics theory and practice (see section 2.2.2, p.15).

Other researchers share a different perspective. Hanna (1989) for example states that the dynamic aspects of dynamic geometry software may stimulate in students the necessity for an analytic proof. Let us assume that a student is asked to prove the theorem stating that the perpendicular bisectors in a triangle meet at one point. The construction in Cabri of this situation has the advantage of clearly showing *that* the theorem is true, thanks to dragging being "at least equivalent to drawing a large number of triangles on paper, or imagining that one had drawn them, and probably more impressive" (Hanna, 1998, p.8). Dragging therefore helps the student to see what Wittgenstein called a "proof-picture". Such exploration provides students with a high degree of trust in the validity of the theorem and with understanding that the theorem is true. "Dynamic software has the potential to encourage both exploration and proof, because it makes it so easy to pose and test conjectures" (Hanna, 2000, p.29). Hanna suggests that teachers should exploit the excitement generated by the exploration phase in order to construct a proof that explains *why* what students see on the screen *is true* and then why it is *always* true. So, dragging and exploration in Cabri support the role of proof as explanation (Hanna, 1998). The need for proof can be constructed on the basis of the fact that in Cabri students can see that a property is true.

The fact that in Cabri properties about figures are shown to be true may lead to the argument that students will not find the need for proving anything they see on the screen. One approach to the problem is that of looking for situations in which some properties are not self evident in Cabri, so as to stimulate students to find other ways to establish if a result is true. Some researchers identified the role of surprise in supporting the teaching of proof (Movshowitz Hadar, 1988; Dreyfus & Hadas, 1996). Hadas, Hershkowitz &

Schwartz (2000) present an approach to enabling students to produce proofs (as deductive justifications) by presenting them with problems that reveal surprising, contradictory or uncertain results. Their design of activities in a dynamic geometry environment brought proofs into the realm of students' activity.

The students ceased to be recipients of formal proofs, but were engaged in an activity of construction and evaluation of arguments in which certainty and understanding were at stake, and they had to use their geometrical knowledge to explain contradictions and overcome uncertainty. (Hadas et al., 2000, p.149)

What emerges from this study is the importance of the tasks used. The use of Cabri in the proving phase must be stimulated in the students by appropriate tasks; otherwise a rupture may occur as forced by the task itself (Laborde, 2001).

As illustrated in the previous chapter, within the approach to proving one of the main difficulties students face is the gap between empirical and deductive/theoretical practices related to it. A number of studies have addressed this issue with respect to the potentialities that dynamic geometry may offer. Hoyles & Jones (1998) claim that dynamic geometry, by allowing the production of auxiliary constructions, extreme cases, and by supporting 'what if' and 'what if not' questions, has the potential to promote links between empirical and deductive reasoning. Jones (2000) reports a study with 12-year-old students dealing with problems around the classification of quadrilaterals in Cabri. The main conclusion from the study is that using dynamic geometry software helped students to progress in their understanding of the dependence relationships among components of a figure and amongst families of figures, and so advance towards a progressive abstraction in their justifications. Marrades & Gutierrez (2000) report on a teaching experiment aimed to make students construct justifications for the correctness of their constructions in Cabri. They show that the way in which students used the software determines their solutions and justifications and the quality of students' justifications improves over time. Bruckheimer & Arcavi (2001) provide an example of the way dynamic geometry can support the development of a proof, by using empirical evidence as the source for insight and inspiration for a deductive argument. On the other hand, other researchers argue that the transition is not possible, because two different ways of reasoning characterise conjecturing and proving. Bolite Frant & Rabello de Castro (2000) argue against the idea of using dynamic geometry to promote a smooth passage from intuitive, pictorial or informal proof to axiomatic proof. Their experiment with teachers showed that Cabri and dragging were useful to generate and test conjectures, but once they decided to prove they stopped using Cabri and looked at the static figure, using axioms and properties to construct the proof. They argue that there are

---

two different approaches: one is intuitive, related to motion, and the other one is static, related to symbols.

Helping students to understand that informal or intuitive mathematical proof is different from formal mathematical proof can help them build connections, because if things are the same (similar) there is no need for connecting them. (Bolite Frant & Rabello de Castro, 2000, p.3)

#### **3.4.4 Dragging and proving: a possible theoretical model?**

A preliminary study concerning the analysis of the dragging function, as far as the support it can provide in the conjecturing and proving process, has been carried out by the author within the Mathematics Education Research Group in Turin (Olivero, 1998). This research analysed dragging from a cognitive point of view, focusing on the way dragging may affect students' reasoning processes and not only on the things dragging allows students to do. A classification of different dragging modalities students might use in solving a problem in Cabri was produced and the cognitive counterpart of dragging investigated (Arzarello et al., 1998; Arzarello, Olivero, Paola, & Robutti, 1999; Olivero, 1999). Classroom observations showed that students' use of dragging changes according to the different aims they want to achieve, that is exploring a situation, trying to make conjectures, validating conjectures, testing conjectures, attempting to construct a justification.

The dragging modalities identified in that study are listed below.

*Wandering dragging*: moving the basic points on the screen randomly, without a plan, in order to discover interesting configurations or regularities.

*Bound dragging*: moving a semi-dragable<sup>9</sup> point, which is already linked to an object.

*Guided dragging*: dragging the basic points of a figure in order to give it a particular shape.

*Lieu muet dragging*: moving a basic point so that the figure keeps a discovered property; that means you are following a hidden path (lieu muet), even without being aware of this.

*Line dragging*: drawing new points on the ones that keep the regularity of the figure.

*Linked dragging*: linking a point to an object and moving it onto that object.

*Dragging test*: moving dragable or semi-dragable points in order to see whether the figure keeps the initial properties. If so, then the figure passes the test; if not, then the figure was not constructed according to the geometric properties you wanted it to have.

---

<sup>9</sup> A semi-dragable point is a point on an object, that can be moved but only on the object it belongs to.

The example below was used to show how these dragging modalities could be successfully exploited in an open problem of exploration. The problem<sup>10</sup> considered is the following: You are given a triangle ABC. Consider a point P on AB and the two triangles APC and PCB. Make a hypothesis about the properties of ABC which are necessary so that both APC and PCB are isosceles (such triangles are called 'separable').

We can find two different configurations, as shown in Figure 3.5 and Figure 3.6.

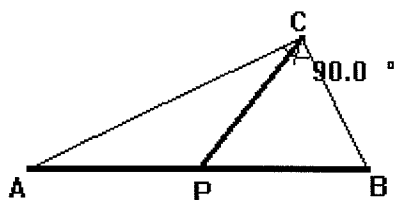

Figure 3.5.  $AP=PC=PB$

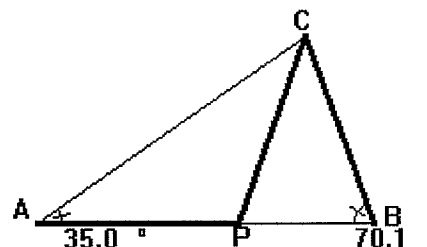

Figure 3.6.  $AP=PC=CB$

We investigate the configuration of Figure 3.5. What are the characteristics of the triangle in Figure 3.5?

In Cabri you draw a triangle ABC and P as the midpoint of AB. Then you start moving the point C, which is a draggable point, all around the screen in order to see whether such triangles (the 'separable' ones) exist. You are doing *wandering dragging*. Through this way of dragging, you find many triangles that satisfy the property (Figure 3.7), so now you are sure that the task has a solution.

Now you go on moving C and you stop when the triangle ABC is 'separable', such as when PC equals AP. Looking at the figure you start thinking about the characteristics of this triangle. In order to know more, you try to drag C in such a way that ABC keeps its property ( $PC=AP$ ). In other words, your dragging is no more 'by chance': you feel that you are moving along a main direction, the one which allows the triangle ABC being divided into two isosceles triangles. Therefore you are using *lieu muet dragging*. The path followed by C cannot be seen, so it is muet, but you could visualise it<sup>11</sup> and perceive that it resembles something known: it is similar to a circle (Figure 3.8).

To understand the situation better you can exploit the *line dragging* by marking the points correspondent to some of the positions occupied by C when ABC has the right property (Figure 3.9). Now you observe that they seem to lie on a circle, exactly on the circle centred in P with radius PA ( $=PB$ ). The *lieu muet* now becomes explicit; by constructing the circle with centre P and radius PA you see that the points previously marked really are on that circle (Figure 3.10). So you conjecture that the 'separable' triangles are those whose vertex C belongs to a circle centred in P and with radius PA. This condition is equivalent to the fact that ABC is inscribed in a circle with AB as a diameter, which means that the angle  $\angle ACB$  is right. Therefore your conjecture can now be more precisely formulated in a logical form: if ABC is a right-angled triangle ( $\angle ACB=90^\circ$ ) then it is 'separable'.

In Cabri you have got a way to validate this statement. By linking the vertex C to the circle discovered by means of line dragging and moving it on that, so using *linked dragging*, you can see that all the triangles that are continuously redrawn satisfy the property of being 'separable' (Figure 3.11).

As a last step you can construct a right-angled triangle ABC, the middle point P of AB, the segment PC and use the *dragging test*, such as move the triangle through all its draggable points and observe that it keeps the required property (Figure 3.12).

<sup>10</sup> This problem is also discussed in (Hölzl, 1995; Hölzl, 1996).

<sup>11</sup> By means of the menu command 'Trace on/off': it traces the path of a selected object as it moves.

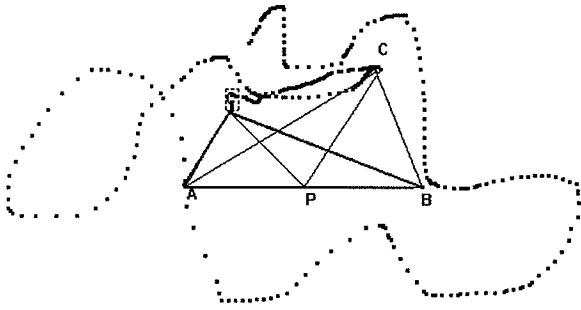

Figure 3.7. Wandering dragging

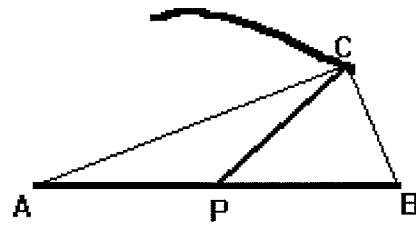

Figure 3.8. Lieu muet dragging

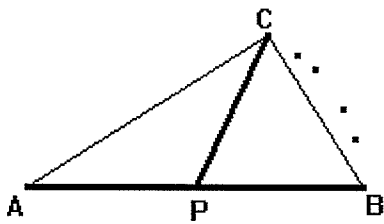

Figure 3.9. Line dragging

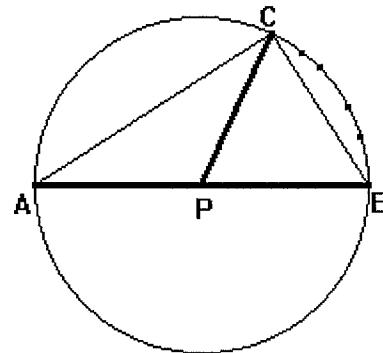

Figure 3.10. Lieu muet becomes explicit

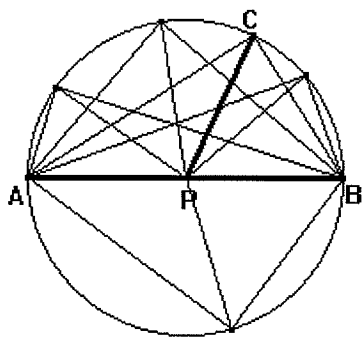

Figure 3.11. Linked dragging

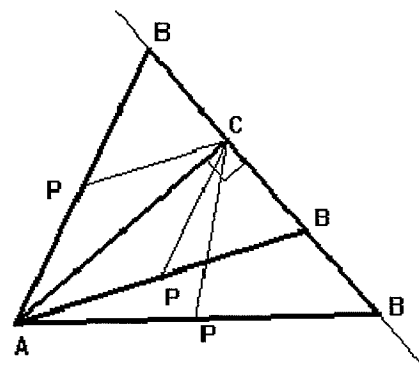

Figure 3.12. Dragging test

As shown by the example above, the different dragging modalities can be used in order to achieve different aims and can be framed in a hierarchy with respect to ascending and descending control<sup>12</sup> (Olivero, 1999).

<sup>12</sup> For details about ascending and descending control see section 2.5.3, p.40.

*Wandering, bound and guided dragging* are used to investigate and explore a given task, so they are part of the ascending control stream.

*Lieu muet dragging* can be seen as a wandering dragging which has found its path; the trace of this dragging represents, at an empirical level, a locus that is not yet visible to the subject. A *lieu muet* can act both as a producer of new powerful heuristics (Hölzl, 1996) and as a logical reorganiser of the previous investigations (Pea, 1987). This modality reveals the beginning of the shift from ascending control to descending control, that is an abduction. The solver is beginning to see a certain relation/property/invariance and he is trying to make sense of it in logical terms<sup>13</sup>. Therefore *lieu muet dragging* supports students in producing abductions, and as a consequence in the transition between the two modalities of control.

*Line dragging* follows *lieu muet*, as it makes the locus explicit and visible on the screen; it is part of the process of transition towards descending control.

*Linked dragging* allows the subject to check his conjecture: if the locus can be constructed in Cabri (e.g. a line, a circle), the subject can link the point to that locus, and the discovered property must be kept through dragging it onto the locus. Therefore it reveals the beginning of descending control. On the other hand it can also be exploited in the exploration process, for example if you want to decrease the free parameters of the initial situation.

*Dragging test* is used as a means of validating a conjecture and it reveals descending control.

### 3.5 SUMMARY

This chapter discussed the impact of the introduction of tools in the context of the teaching and learning of mathematics, with particular attention to the case of dynamic geometry software. Issues concerning the interactions taking place between pupils working at the computer have also been discussed.

This research takes on board the 'instrumental approach' to technology (Verillion & Rabardel, 1995). Rabardel (1995) states that on the one hand there is an *artefact*, i.e. the particular object with its intrinsic characteristics, designed and realised for the purpose of

---

<sup>13</sup> If drawn figures keep some regularity, then the point C describes a certain locus L. If C runs on L, then the corresponding figures F(C) show some regularity, invariance or rule.



---

accomplishing a particular task, and on the other hand there is an *instrument*, that is the unity of the artefact and the modalities of its use, as they are elaborated by a particular user. Therefore the same artefact may become different instruments to different users. Cabri is considered in this perspective and the process of 'instrumentalisation' of Cabri, and dragging in particular, will be studied. This process relates to the process of 'internalisation' of a tool (Vygotsky, 1978): a transformation takes place from an externally oriented artefact, with the aim to perform an action (*technical tools*) to an internally oriented instrument aimed to control the action (signs or *tools of semiotic mediation*).

The studies concerned with students collaborating *at* the computer have shown different ways of interaction between students working with a same computer task. The key element which emerges from all research is the importance of the construction of a shared space of interaction to bring students to a shared understanding of the situation they deal with. This project will study processes of coming to this shared understanding within the particular case of dynamic geometry software and the role of this in the development of the proving process.

Many functions can be attributed to proof (see section 2.2.2). When it comes to the teaching and learning of proof in the classroom, deciding which function is to be attributed to proof is fundamental in order to plan a useful approach to proof. When considering ways of supporting students in proving activities, the function proof has with respect to the chosen tools constitutes an issue for discussion. For example, dragging in Cabri allows students to validate their conjectures; therefore the function of convincing (oneself or a friend) that proof has in mathematics is no longer useful. The work in Cabri is enough for the students to be convinced of the validity of their conjectures. If the teacher does not motivate students to find out *why* a conjecture (proposition) is true, then the justifications given by students may remain at an empirical level: the proposition is true because the property observed on the Cabri figure stays the same when dragging the figure, given that the hypotheses do not change. When such a belief is shared in the classroom, then Cabri might become an obstacle in the transition from empirical to theoretical thinking, as it allows the validation of a proposition without the need to use a theory. However, if the teacher makes explicit the role of proof in explaining why, then students will be motivated to prove *why* a certain proposition is true (within a theory), after they know *that* it is true (within the Cabri environment). To paraphrase Polya (1954), first we need to be convinced that a proposition is true, then we can prove it.

## CHAPTER 4. THE TEACHING AND LEARNING CONTEXT

*There is a widespread belief in what I have previously called the "fingertip effect": Simply make a support system available and people will more or less automatically take advantage of the opportunities that it affords. [...] However, considerable evidence argues that the fingertip effect is a sham.*

*(Perkins, 1993, p.95)*

### 4.1 INTRODUCTION

The core part of this research, whose overall aim is to investigate the processes taking place in the construction of conjectures and proofs within a dynamic geometry environment, is constituted by intervention studies in multiple school settings, in England and in Italy. The rationale for carrying out intervention studies was the need to create an appropriate context (as will be described in chapter 5) for the investigation of the research aims, within an authentic classroom environment. The interventions consisted of a series of classroom sessions in which students were asked to solve open geometry problems using Cabri. In all settings the teacher was in charge of the teaching in the classroom.

In this chapter the setting for each of the classroom interventions is described and the methods of working explained. The first section will describe the English setting, while the second section will deal with the Italian setting. Finally the key elements characterising both contexts will be discussed.

### 4.2 THE ENGLISH SETTING

The intervention study in the English setting consisted of a project aimed at introducing a group of Further Mathematics A-level students to proving; it was carried out within a

collaboration between a comprehensive school (Churchill School) and the Graduate School of Education<sup>1</sup> in Bristol in the period September-October 1999.

#### 4.2.1 The subjects involved

The subjects involved in the project were five A-level Further Mathematics students from a comprehensive school (Table 4.1), one mathematics teacher, the IT co-ordinator and four researchers from the University. The IT co-ordinator was in charge of the technical part of the project.

The students had a strong mathematical background. They were described by their teachers as very bright students in general. They often worked together at school, so they were used to working as a group. They had never used Cabri before, except for a first session we held in the Graduate School of Education before the start of this project. They were used to doing open-ended activities and projects in school and to working in groups. They agreed to take part in the project spontaneously, with the expectation of gaining some understanding of proof before beginning University.

Students	Use of Cabri	Teacher	Classroom background
17-18 years old - Churchill school	They had never used Cabri before this intervention.	The teacher used to making the students work together as a group.	They have a strong mathematical background. They are used to working together as a group.

Table 4.1. The students involved in the English setting

#### 4.2.2 Aims of the intervention

The general aim of the project in Churchill School was to introduce the students to proving with the support of Cabri. Cabri was meant to be used as a tool for learning and the focus was on the mathematics rather than on the software itself.

The learning objectives to be addressed by the classroom intervention were:

- conjecturing;
- validating conjectures;
- proving validated geometrical properties;

---

<sup>1</sup> This project was carried out by: G. Moëne, C. Mogetta, F. Olivero & R. Sutherland, Graduate School of Education, University of Bristol in collaboration with Churchill School.

- moving between conjecturing and proving.

The mathematical area was chosen to be geometry.

The project was developed in different phases in which all the participants in the research (the four researchers, the mathematics teacher from the school and the IT co-ordinator) worked together. First, the teacher and the researchers elaborated a sequence of Cabri and paper and pencil activities to be carried out over a period of 7 classroom based sessions. The plan was intended to provide an idea of the range of things that could be done in the period of time available. However, we did not strictly follow that plan; the activities were changed during the experience according to the students' responses in terms of motivation and performance. Secondly, the experience was carried out in the classroom. The teacher was in charge of the teaching and the researchers carried out the data collection. Sometimes they also intervened to support the teacher either with the activities or with the students' questions. The design of the project served to create an authentic setting for multiple research purposes. The last phase constituted by the analysis of data was carried out independently by all the researchers, who looked at different parts of the data and from different perspectives.

The problems given to the students (see Appendix A, p.261) were chosen both to meet the learning objectives and to introduce students to Cabri. Therefore the first session in the classroom was mainly focused on the use of Cabri through constructions, so that students could learn the basic dragging test<sup>2</sup>. After the first session we realised that the students could manage Cabri quite well, as far as the features that we wanted them to be able to use, i.e. general dragging, the principle of *dragging test*, and constructions. We then decided to focus on the mathematics, intervening to show other Cabri features only when needed as the project went on.

### 4.3 THE ITALIAN SETTING

The intervention study in the Italian setting consisted of a series of four classroom sessions carried out in three secondary schools (two Liceo Scientifico and one Liceo Psico-

---

<sup>2</sup> The *dragging test* allows one to see if the construction is stable under dragging, i.e. if the figure was constructed according to the geometric properties required.

---

pedagogico<sup>3</sup>) in Finale Ligure and Turin (15 to 17 years old students), in the period February-March 2000.

#### 4.3.1 The subjects involved

The four classrooms involved in the intervention study were part of an ongoing project which concerns teaching experiments centred on the teaching of geometry and proof with the use of new technologies, Cabri in particular. The three teachers of these classrooms participate in a Mathematics Education Research Group at the University of Turin, which involves teachers experimenting with new approaches to teaching mathematics in the classroom. This group usually meets once every two weeks throughout the school year. Teachers and researchers collaborate in the development of new materials for the classroom, in the implementation in the classroom and evaluation<sup>4</sup>. One strand of the project involved teaching experiments addressing 15-17 year old students as regards the teaching and learning of proof with new technologies, dynamic geometry in particular. The final aim of these experiments was to develop a mathematics curriculum in which the Cabri environment was integrated into the teaching of geometry and proof. The teachers were trying out different kinds of activities in the classroom and different methodologies of working. The main characteristics of these innovations are the use of open problems (see 4.4.1) and of classroom discussions (Bartolini Bussi, 1996).

The classrooms involved in the research were part of this strand of the project. Around 25 students were present in each classroom, which were all mixed-ability<sup>5</sup>. The students were used to working in groups and to tackling the sort of problems I used in the study, working in a non-traditional environment. Some of these classrooms had been using Cabri for some time before my intervention, while some others were just starting. The three teachers of the four chosen classrooms<sup>6</sup> voluntarily agreed to take part in the study and the students were told about the research project. Table 4.2 shows the classrooms and students involved in this intervention, together with the teacher and classroom background.

---

<sup>3</sup> A Liceo is a type of secondary school where reasonably good students usually go. When they finish this secondary school students then usually go to university. It lasts 5 years (age 14-19) which are counted as I, II, III, IV and V.

<sup>4</sup> The group has been working in different areas addressing the needs of all secondary school levels (e.g. Projective geometry with the use of real drawing tools with 17-18 year old students and Non Euclidean geometries with 18-19 year old students).

<sup>5</sup> All classrooms in Italian schools are mixed-ability.

<sup>6</sup> See chapter 5 (section 5.4, p.82) for the criteria of selection.

<b>Students</b>	<b>Use of Cabri</b>	<b>Teacher</b>	<b>Classroom background</b>
Class IVD (17-18 y.o.) Liceo Scientifico Issel, Finale Ligure	They used Cabri for a year before this intervention.	The teacher is working within the Mathematics Education Group in Turin. He is involved in many research projects. He is a teacher-researcher.	Students are used to working in groups, to open problems, to discussing their solution processes in the classroom and with the teacher (see Furinghetti, Olivero, & Paola, 2001). Their mathematics background varies.
Class IIE (15-16 y.o.) Liceo Scientifico Galileo Ferraris, Turin	They started using Cabri at the beginning of the school year in which the intervention took place.	The teacher belongs to the Mathematics Education Group in Turin. She is used to setting open problems and to solving problems with the students in the classroom. She is a teacher-experimenter.	Students are used to working with open problems. Many of them are quite keen on maths and spend a lot of time trying to solve difficult problems. The classroom atmosphere is stimulating. Students represent a wide range of abilities.
Class IIC (15-16 y.o.) Liceo Psico- pedagogico Berti, Turin	They used Cabri just once at the beginning of the school year in which the intervention took place.	The teacher is working within the Maths Education Group in Turin. She is keen on trying out innovations. She is involved in the project of developing a Cabri-geometry curriculum. She is a teacher-researcher.	The students have quite a weak mathematical background.
Class IID (15-16 y.o.) Liceo Psico- pedagogico Berti, Turin			

Table 4.2. The students involved in the Italian setting

#### 4.3.2 Aims of the intervention

The learning objectives to be addressed by the intervention in the four Italian classrooms were the same as for the English project, that is:

- conjecturing;
- validating conjectures;
- proving validated geometrical properties;
- moving between conjecturing and proving.

The mathematical content chosen was geometry.

---

Although the intervention was structured so that it met my research needs, the teachers were to be an active part of the intervention and they participated in the planning and carrying out of the sessions. The intervention consisted of one session for each of the four classrooms (see Appendix B, p.266). Before each classroom session, I chose an open problem together with the teacher. Then the actual classroom session was run by the teacher himself/herself.

#### **4.4 THE KEY ELEMENTS OF THE TEACHING AND LEARNING CONTEXT**

This section will discuss the key elements which characterised the teaching and learning context of the classroom settings.

##### **4.4.1 Open problems in Cabri**

I decided to use open problems (in geometry), based on both research needs and theoretical considerations. This choice draws on previous studies, which have shown that in a paper and pencil environment students are more likely to construct proofs if they can perform explorations of the situation first (Garuti, Boero, & Lemut, 1998). According to this study, after conjecturing it seems that the students may re-use the bits already discovered to arrange them in a logical deductive sequence constituting a proof. One of the ways to let students carry out exploration and conjecturing before proof was considered to be the use of open problems. The characterisation of open problems used here draws on the French definition given by Arsac, Germain & Mante (1988) but refines it with new features<sup>7</sup> (Mogetta, Olivero, & Jones, 1999; Olivero, 1998).

- The statement is short, and does not suggest any particular solution methods or the solution itself. It usually consists of a simple description of a configuration and a generic request for a statement about relationships among elements of the configuration or properties of the configuration.
- The questions are expressed in the form “which configuration does...assume when...?” “which relationship can you find between...?” “What kind of figure can...be transformed into?”.

A problem presented in an open form cannot be reduced to the implementation of a procedure or a routine that has to be remembered by heart. On the contrary, students have

---

<sup>7</sup> For examples of open problems see Appendix A (p.261) and B (p.266), where the problems designed by the author to be used in this research are presented.

to make their own decisions in choosing a solution path. They are in a situation in which they really have to 'discover' a result, one that may even not be unique. An open problem allows freedom in producing conjectures. It requires students to pose questions rather than only answer predetermined ones. In order to solve an open problem students have to undergo the following process: exploring the situation, making conjectures, validating conjectures and proving them. The process of solution becomes as important as the solution itself; the attention is not only on producing the 'correct result', but on 'how to produce a result'. In this sense open problems seem to be suitable to stimulate productive thinking: "problem formulating is a good companion to problem solving. [...] Problem formulating should be viewed not only as a goal of instruction but also as a means of instruction" (Kilpatrick, 1987, p.123). In geometrical problem solving, the suggestion is that proving a result that has been discovered and validated by students themselves is more meaningful than proving something they are given, but do not understand. Some research (e.g. Boero, Garuti, & Mariotti, 1996a; 1996b) has suggested that providing students with tasks which state 'prove that ...' might inhibit students' capacity for proving. In contrast, open tasks which favour a dynamic exploration of a statement might allow students to reconstruct, in terms of properties and relationships, all the elements needed in the proof. Moreover, open problems should foster a wide mathematical production, in that all the students usually succeed in observing something from the situation they are exploring, while in problems of the form "prove that..." most students think a brilliant idea is needed in order to be able to provide a solution and so they get stuck.

#### **4.4.2 The classroom sessions**

In both settings the classroom sessions involved three phases.

- First, the teacher introduced the problem.
- Second, students solved the problem in pairs with Cabri and paper and pencil, producing conjectures and proofs. In the English setting, we asked them to write down (either on the screen or on paper) the conjectures and the proofs. They also had to prepare an OHP with the results they wanted to show to the whole class. In the Italian setting only in three classrooms we asked the students to write down conjectures and proofs and also anything they wanted to write throughout the proving process. In the other two cases we did not ask students for any written work. The choice of making them write down or not was due to research purposes.



- 
- Third, the teacher orchestrated a general discussion, in which students exposed, confronted and discussed their conjectures and proofs.

#### **4.4.3 Working in pairs at the computer**

Another key element of the interventions was the fact that students were asked to work in pairs at the computer<sup>8</sup>.

The following criteria, suggested by both the learning objectives and the research aims, were taken into account when dividing the students in pairs:

- avoiding the presence of very extrovert and very introvert students in the same group, in order to foster group discussion;
- putting in the same group students who are happy to work together and are used to doing it, in order to provide a friendly atmosphere, in which students would talk;
- providing the same level of students' achievement within a group, in order to avoid very good students providing the solution too quickly and to let everyone take part in the process.

In the Italian setting the pairs were chosen by the teacher.

In the English setting, since there were five students we decided to have two pairs and one student working alone. This decision took into account both the learning objectives and the research purposes. In the first session the pairs were chosen by the teacher in order to put together students of same 'abilities' (even if they were all bright) and who worked well together. The pairs were: Alice and Will, Stuart and Ian. Patrick worked on his own.

### **4.5 SUMMARY**

This chapter has set the context in which the investigation of the aims of the projects took place. As we will see in the next chapter, the context is an integral part of the methodology of the study. The problems chosen, the ways students were asked to work at the computer, the structure of the classroom sessions, the students' background are important factors to be taken into account in the investigation of the aims. Some of the key elements of the teaching and learning context in fact were also considered as research instruments, as will be discussed in chapter 5.

---

<sup>8</sup> This decision relied on theoretical considerations (see chapter 3, section 3.3, p.51 and will be further discussed in chapter 5, section 5.5, p.85).

## CHAPTER 5. THE RESEARCH PROCESS

*One cannot ordinarily follow how a researcher got from 3600 pages of field notes to the final conclusions, sprinkled with vivid quotes though they may be.*

*(Miles & Huberman, 1994, p.16)*

### 5.1 INTRODUCTION

The overall aim of the project was to investigate the processes leading students to the construction of conjectures and proofs in geometry, when interacting with a dynamic geometry environment, with particular respect to the interplay between empirical and theoretical elements. In particular, the main aims of the research were the following.

- To investigate the development of the proving process (i.e. the construction of conjectures and proofs) within a dynamic geometry environment.
- To investigate the interactions taking place in the proving process.

In order to investigate these aims, within the classroom interventions described in chapter 4, observations of pairs of students were carried out. The main focus of the research is a process (i.e. the proving process), so that a variety of teaching and learning settings to be used for the main investigation was considered appropriate. My participation in the studies was in planning the classroom sessions (by choosing the problems to be given to the students) and in observing selected pairs of students in each session. The methods of data collection used were video-recording and collection of materials. The data available for the

---

analysis were transcripts from the video tapes, the Cabri files and the students' worksheets. The analysis of data included in-depth analysis of selected cases studies, with the purpose of developing an analytical and explanatory framework for the development of the proving process in dynamic geometry environments.

This chapter is divided into eight sections, which together describe the complete research process (section 5.11), which includes choosing a methodology (section 5.3), selecting case studies (section 5.4), choosing appropriate research instruments (section 5.5), carrying out the data collection (section 5.6) and finally analysing the data (section 5.7). Issues of validity, reliability and generalisability of the research will be discussed together with ethical issues (section 5.9 and 5.10). A first section (section 5.2) will briefly sketch some methodological implications from an exploratory study carried out before the main study.

## **5.2 IMPLICATIONS OF AN EXPLORATORY STUDY**

An exploratory study was carried out prior to the main study in the period March-April 1999. It was a teaching experiment in a classroom of Year 10 students in Bristol. This exploratory study was aimed at developing the theoretical model about dragging (see section 3.4.4, p.66) and suggesting further development and refinement, in order to develop more precise research aims and questions and to elaborate an appropriate design for the main studies. The main results from the exploratory study are presented in the paper (Olivero, 2001). This section will briefly sketch the implications for the design of the main study, especially from a methodological point of view.

This exploratory study was a classroom intervention in which I took the role of participant observer (Brown & Dowling, 1998). Since the teacher had never used Cabri before but was willing to use it in the classroom, he let me take much responsibility for both the planning and the carrying out of the experience. This method of working in the classroom however was not successful from the research point of view. General observations of the classroom sessions do not allow an investigation of the elements that are needed to carry out a fine analysis of students' work. In fact, having to be in charge of the sessions just allowed me to have a sense of what was going on, at a very general level. Therefore it was decided for the main studies that I should have a less participant role, at least observing situations in which the teacher is in charge of the session while it is actually taking place. The design changed from an intervention study to classroom observations within classroom interventions, with different degrees of involvement of the researcher (Brown & Dowling, 1998). This also reflected a change in the focus of attention: the exploratory study was more focused on

---

students' learning objectives whereas the main studies were more focused on the research perspective. In fact, one aim of the exploratory study was to develop a sequence which could be used by teachers as part of the curriculum. While carrying out the intervention, I realised that more work needed to be done at the level of the analysis of processes, while the kind of activities used seemed to serve the purposes both at research and at didactical level. Therefore the main study took for granted the kind of problems to be used<sup>1</sup> and focused on the analysis of students' processes in order to explain better the impact of Cabri.

In the exploratory study the intention was to keep track of the work from all of the students in the classroom. So I tried to pay attention to the whole classroom, without focusing on some students in particular. The new aims and research questions however required much more detailed observations, which forced the decision to choose one pair of students only to be observed in each classroom.

A tape recorder was used to record the work of one pair of students, in order to try out means of observation. I realised that this was not sufficient if the use of Cabri was to be analysed in detail. In fact, it was very difficult to make sense of what students say in the tapes, without having the image of what they were doing in Cabri. Therefore it was decided to use a video camera instead. Moreover in the tapes it is difficult to distinguish the voice of the students we wanted to observe because the whole classroom voices were recorded as well. An appropriate classroom setting was then thought about for the main studies, as discussed later on.

### **5.3 CHOOSING A METHODOLOGY**

The need for understanding the proving process and trying to provide explanations for what happens in the process led me towards a qualitative methodology, both in the data collection and in the data analysis. Overall the methodology used consisted of observations of case studies of pairs of students in multiple classroom settings (described in chapter 4) and "theory-building" (Eisenhardt, 2002) from case studies.

Five main characteristics of qualitative research are: naturalistic, descriptive, concerned with process, inductive, concerned with meaning (Bogdan & Biklen, 1998, p.27-30). These features well addressed the needs of my study. First of all, the object of study was a process, rather than a product and the focus of the research was on understanding how this

---

<sup>1</sup> See section 4.4.1, p.76.

---

process occurs. In order to observe the proving process as it occurs, a naturalistic setting was required: a classroom environment was then chosen as the research setting, believing that “to divorce the act, word, or gesture from its context is, for the qualitative researcher, to lose sight of significance” (Bogdan & Biklen, 1998, p.27). The researcher had a key role in this setting, with “the researcher’s insight being the key instrument for analysis” (Bogdan & Biklen, 1998, p.27). The kind of data needed to investigate that process was of a descriptive form, as external evidence of the development of the proving process.

As a qualitative researcher planning to develop some kind of theory about what you have been studying, the direction you will travel comes after you have been collecting the data, after you have spent time with your subjects. You are not putting together a puzzle, whose picture you already know. You are constructing a picture which takes shape as you collect and examine the parts. ... The qualitative researcher plans to use part of the study to learn what the important questions are. (Bogdan & Biklen, 1998, p.29)

An inductive process of analysis was to be carried out, starting from some theoretical assumptions, but being open to ‘read’ the data in order to develop the categories of analysis. In fact, even if I started the study with an idea of what elements I wanted to observe in the process, the data collection and preliminary analysis suggested new variables which were revealed to be important for the development of conjecturing and proving, which were then added to the initial framework (see section 5.8). Therefore the framework evolved throughout the project.

Within the general framework of qualitative research, trying to understand and explain the complexity of the processes of conjecturing and proving that students use while solving open problems in Cabri is a task which requires fine observations and analysis of the interactions of the students between each other and between the students and the computer<sup>2</sup>. The case study approach suited well the need of working with a relatively small amount of appropriately selected cases (see section 5.4) and carrying out an in-depth investigation of those.

#### **5.4 THE STUDENTS INVOLVED**

The main focus of the research was a deep and fine analysis of students' proving processes. This focus determined the choice of the sample to be observed. The selection of cases to be involved in the data collection involved the selection of some schools, the selection of classrooms within the schools and the selection of case study students in the classrooms. The process of selection was based on a number of criteria, both theoretical (Silverman,

---

2000; Eisenhardt, 2002) and practical, which are described below. Overall, I tried to integrate both the teachers' agenda and my research agenda, when setting out the criteria for sampling. Generally speaking, I wanted the activities students were presented with (open proof problems in geometry using Cabri) to fit into their normal classroom practice, in order to have the possibility of observing students in authentic classroom settings, but at the same time I needed situations in which the proving process was "transparently observable" (Eisenhardt, 2002, p.13). The set criteria were:

- the students had to be dealing with conjecturing and proving in the curriculum;
- the students had to be using Cabri in the classroom (or having used it at least a couple of times before the intervention);
- the students had to be used to the methodology of working in pairs (or in groups) and of tackling open problems;
- the students had to be likely to produce conjectures and proofs (so that the proving process could be observed) and therefore be middle to high achievers;
- the students had to be talkative (this is very important for research purposes, as the analysis was based on what is 'visible' from the process, and talk is one of the means to make things 'visible');
- teachers had to voluntarily agree to take part in the research and share the research background.

The criteria listed above meant that secondary school students needed to be chosen, as the curriculum of both countries includes proof (in a more or less extended way) only since the beginning of secondary school. In Italy the subject of proof is a core subject only in one type of secondary school, that is the Liceo<sup>3</sup>, so that the choice of schools in Italy was constrained.

A collaboration between a school and the Graduate School of Education in a project aimed at introducing proof and Cabri to some Further Mathematics A-level students, provided access to an English classroom setting (Churchill School in Bristol) which satisfied the

---

<sup>2</sup> The interactions between the students and the teacher are believed to be also very important but are not objects of this research.

<sup>3</sup> Liceo is a type of secondary school where usually good students go. However there is no selection process. They have 4 mathematics classes per week.

---

above mentioned criteria<sup>4</sup>. An ongoing project within a Mathematics Education Research Group at the University of Turin<sup>5</sup>, in which teachers and researchers collaborate in the development, implementation and evaluation of new materials for the classroom<sup>6</sup> provided access to a suitable Italian school setting, formed by a number of schools (Liceo Issel in Finale Ligure, Liceo Galileo Ferraris and Liceo Berti in Turin). The kind of problems I wanted students to tackle fit well within these classroom experiments and teachers were normally happy with trying out new activities. Therefore it was easy to have access to some of their classrooms.

Within these multiple settings, some classrooms had to be chosen. In England there was only one classroom available. In Italy the choice of the classrooms to observe was practical, in that I identified from the three schools the teachers who, at the time of the observations, were working on topics related to the kind of problems I wanted to use and also the teachers who had time to run the activities I wanted. So, the classrooms involved in the research were one A-level Further Mathematics course (17 years old) from a comprehensive school in England and four classrooms (15-17 years old) from three Secondary schools (Liceo) in Italy. Such a variety of schools and classrooms is appropriate to the aim of investigating processes (proving processes) and to the fact that I was interested in the development of the proving process itself and not in the evolution of single students' proving processes over time. All students in the study had used Cabri some times before the observed sessions. As far as the mathematical background, the English students were described as bright by their teachers, while the Italian students were mixed ability, showing a wide range of mathematics performances within the same classroom. All students were also used to working in pairs and to tackling open ended and exploratory activities. The English students decided to take part in the project spontaneously, with the expectation of getting some understanding of proof before beginning University, while the Italian students were told they were part of a research study, in which their teachers had agreed to participate.

I decided to observe only one pair of students from each classroom session while solving the given problem. This was due to the choice of carrying out an in-depth study and also to a practical reason: since the observations were taking place in a classroom, I did not want to

---

<sup>4</sup> See section 4.2, p.72 and Appendix A for more details about the project.

<sup>5</sup> I was involved in this group while doing the dissertation for my first degree (see chapter 1).

use too much equipment, which would have been needed to observe more students. As far as the choice of the pairs of students within the classrooms, meeting the criteria set above, in the Italian setting I relied on the teacher's suggestions, since I did not know the students well enough to know how they usually worked in the mathematics classroom. In the English setting, I decided which pairs to observe, based on a first session in which I could have a sense of the interactions taking place. Two pairs were observed in different sessions.

Table 5.1 summarises the schools, classrooms and case study students which were selected for the research.

	<b>English setting</b>	<b>Italian setting</b>
<b>Schools</b>	1 comprehensive school	3 secondary schools (Liceo)
<b>Classrooms</b>	1 A-level course	4 classrooms
<b>Case study students</b>	2 pairs	4 pairs

Table 5.1. The students involved in the research

## 5.5 THE RESEARCH INSTRUMENTS

Some of the key elements of the teaching and learning context (see chapter 4, section 4.4, p.76) were also used as research instruments, as explained below. In fact, both the research aims and the learning objectives were taken into account throughout the whole research process.

Studying the proving process meant finding a context for it to happen and be easily observed. The choice of the mathematical context, i.e. the problems, in which I wanted to observe the students, was a crucial research instrument to be selected. Open problems (see section 4.4.1, p.77) were revealed to be a good context for observing the proving process, because they allow observing the whole process from exploring to conjecturing to proving. I chose the problems together with the teachers, so that they met the research needs. The problems used are not the same in all the observations, but they are comparable in terms of difficulty and type. They involve only basic elementary geometry properties, which should have been available to all the students observed, and they all require focusing on relationships between two quadrilaterals which are linked by a certain construction (see appendix A and appendix B for the set of problems used).

The fact that the computer demands a semi-formal articulation of relationships, implies that the computer offers a window, not just onto the teacher and learner, but onto the observer as well. It affords a view of the meaning-making process, a glimpse of learning which is often difficult, if not impossible, to catch. The computer provides a screen on which learners can express their thinking,

<sup>6</sup> See section 4.3, p.74 for more details.



---

and simultaneously offers us the chance to glimpse the traces of their thought. (Noss & Hoyles, 1996, p.6)

Sharing this statement, Cabri was seen as a research instrument too, besides as a tool in the proving process. I thought that the fact the students could construct and manipulate figures in Cabri would show part of their thinking throughout the proving process.

Moreover, asking students to work in pairs became a research instrument too, in that in this way it is more likely that they make explicit their cognitive processes, as they have to explain to one another what they think or do<sup>7</sup>.

## **5.6 COLLECTING DATA**

Within the framework of qualitative case studies, the instruments and methods to go about collecting the data were defined. This section describes the methods of data collection which were found appropriate to the research aims.

The research aims required the analysis of students' processes of production of conjectures and proofs and of the interactions between each other and with the computer, therefore I needed to have access to these processes. The processes are constituted by both external practices, that is what students do and say (e.g. dragging in Cabri, drawing, sketching, talking, etc...), that can be directly observed, and by internal practices, that is their processes of reasoning, which can only be inferred on the basis of the observations. In terms of methods, choices needed to be made as far as the means of observations of these practices.

### **5.6.1 Video-recording**

The best research tool to gain details of student interactions with each other, with the computer and with the mathematical ideas involved in the problems was found to be the video-recording of students' work, which provides a detailed and accurate record. In particular, the use of Cabri and other tools (as paper and pencil) and the interaction between the students was to be analysed, so both audio and video data were needed, as what students did and said needed to be studied as a whole. The complexity of such processes was well captured by the video camera.

A decision about what to record had to be made. The computer screen was needed, but also students' gestures with hands and their writing on paper. This information could be

---

obtained by moving the video camera to follow what the students were doing. However, in the cases in which multiple activities were going on (e.g. one student working with paper and the other working with Cabri), it was not possible to capture everything visually. The students' talk helps in reconstructing what is not visible<sup>8</sup>.

Six classroom sessions were observed within the selected classrooms. One pair of students from each classroom session (see 5.4 for the criteria of selecting the pair) was videotaped while solving the given problem. In the English setting, in some sessions the classroom discussion after the pairs' work was video-recorded too. The sessions lasted one hour and a half to two hours approximately.

### **5.6.2 Fieldnotes**

Fieldnotes for each video-recorded pair of students were also taken, in order to provide more context from the situation, which could not be captured by the video camera. Moreover, observing the students allowed me to have a general sense of the overall process straight after the session, while the video was then used for the detailed analysis.

### **5.6.3 Collection of material**

All the paper materials students produced were also collected, as I was interested in the use of different tools used in the process. In some cases I collected the paper work from the whole classroom, in order to get a sense of the general productions. As far as the specific role of Cabri in the process is concerned, the students' Cabri files<sup>9</sup> were collected.

### **5.6.4 Data collected**

The raw material collected through the previously described research methods, appropriately transformed, constituted the main corpus of data to be subsequently analysed. It consisted of fieldnotes, transcripts from the video recording, students' worksheets and Cabri files, as shown in Table 5.2.

---

<sup>7</sup> This for example is different from getting access to their thinking by carrying out one-to-one interviews, where students are forced to talk aloud, and this might be unnatural for them. It might also disturb their thinking and distract them. The process studied in such interviews might be different from what students would normally do.

<sup>8</sup> In the English setting some problems with the video-camera occurred, because it was the first time we used the video-camera and the definition of what to observe was refined over the whole research process. In fact, the camera was fixed on a tripod in a way that would capture the computer screen mainly. Because it was fixed, the observer in charge of it did not stay with it all the time, therefore sometimes it was not moved in time to follow the students when they switched to paper.

<sup>9</sup> A method to gather useful Cabri data would have been the 'recording session' feature of an experimental version of Cabri: this allows to record every action students do in Cabri (constructions and dragging) and to play it back. Unfortunately I could not install this version of Cabri in any of the schools I went to, due to technical problems.

Methods of data collection	Data collected
Taking fieldnotes	Typed fieldnotes
Video-recording	Transcripts of video-tapes
Collection of materials	Students' worksheets & Cabri files

Table 5.2. Collecting data

In particular, the data collected from the two settings are illustrated in Table 5.3 and Table 5.4.

Classroom	Problem	Transcripts	Cabri files	Written work	Field notes
Churchill	Angle bisectors of a quadrilateral	Alice&Will discussion	All students	All students	Alice&Will
Churchill	The square problem	Stuart&Ian discussion	All students	All students	Stuart&Ian

Table 5.3. Data collected from the English setting

Classroom	Problem	Transcripts	Cabri files	Written work	Field notes
II E Liceo G.Ferraris	Perpendicular bisectors of a quadrilateral	Bartolomeo & Tiziana		All students	Bartolomeo & Tiziana
II C Liceo Berti	Perpendicular bisectors of a quadrilateral	Debora & Giulia		Debora & Giulia	Debora & Giulia
II D Liceo Berti	Varignon's problem	Alessandra & Tiziana		All students	Alessandra & Tiziana
IV D Liceo Issel	Perpendicular bisectors of a quadrilateral	Valentina & Michela & Elisa		Valentina & Michela & Elisa	Valentina & Michela & Elisa

Table 5.4. Data collected from the Italian setting

### 5.6.5 The role of the researcher

This section discusses my role as researcher in the classroom.

Given that data were to be collected within an intervention study, I was faced with the decision of what degree of participation I wanted to have in the research, being aware of the fact that

limits are placed on the possibility and desirability of being a complete participant by the necessary differences between taking part in an activity, on the one hand, and the production of an analytic account of that activity, on the other. (Brown & Dowling, 1998, p.45)

and that

The options for an observer are conventionally marked out on a continuum from complete participant to complete, non participant, observer. Both ends of this continuum are problematic. (Brown & Dowling, 1998, p.45)

---

Taking into account the suggestion that came from the exploratory study, as described in section 5.2, the role I decided to have in the classroom was an intermediate one between these two extremes and was redefined in each school setting, according to the real situation I had to work in.

In both the English and Italian settings I took an active role in the planning phase of the intervention: the problems to be given to students and the methodology of working in the classroom were planned in negotiation with the teachers. Then, during the actual classroom situation, I decided to let the teacher be responsible for the teaching and the development of the learning situation as much as possible, so I acted as a semi-participant observer. I either took fieldnotes or used the video camera for the one pair of students chosen to be observed in each classroom.

Up to four researchers<sup>10</sup> were present in the classroom sessions in the English setting, including myself. We all had different roles as observers. I took fieldnotes of the pair of students which was chosen to be video-recorded. Another researcher was in charge of the video camera. The other two researchers generally observed the remaining students, taking fieldnotes. Since all of us were involved in the planning and implementation of the project (see chapter 4, p.73), and the use of Cabri was new to the teacher, sometimes we had to discuss things with the teacher during the session while the students were working or to help with the use of the software<sup>11</sup>. In this sense, my role was of semi-participant observer.

In the Italian setting, two researchers<sup>12</sup> were present in each classroom session. Given the different characteristic of the classroom interventions these sessions belong to (see chapter 4), there was no need for us to be participant in any way. We acted as completely detached observers (Gold, 1958). One researcher video-recorded the chosen pair of students while the other one observed the same pair and took fieldnotes. In this setting I could not be present in all the sessions, except for 2 out of 4. In the other two sessions an Italian research student was in charge of the video camera. The kind of data I needed to collect and analyse (the videos and the written students' work) did not require the physical presence in the

---

<sup>10</sup> As far as the use of data from the project, the four researchers (including myself) were interested in different things. They all participated in the planning phase, but they then collected different data from the project to be analysed according to different aims and in a number of different ways.

<sup>11</sup> In all settings I was never alone as observer in the classroom. And the fact of having two or more observers and different methods of collecting data, was useful in avoiding major loss of information.

<sup>12</sup> The two researchers were myself and a researcher from the Mathematics Education Research Group in Turin, or two researchers from the Mathematics Education Research Group in Turin, when I could not be present in the classroom.

---

classroom as fundamental. Moreover, I knew the classrooms well because I had already done some observations over previous years and I also knew the teachers.

Despite defining my role as detached in the Italian setting, the need for choosing what to have recorded by the video camera made the role of the researcher in general not totally detached. Choices made during the video recording influenced the set of data which were then available for the analysis, and ultimately had an impact on the analysis itself. Even when not using the video camera myself, I always shared my ideas in terms of what I wanted to be video-recorded with the person actually doing the video recording.

## 5.7 ANALYSING THE DATA

The phase following the gathering of data involved deciding what to do with that material and what data to use for the main analysis. "Qualitative data analysis is a continuous iterative enterprise" (Miles & Huberman, 1994, p.12). The process of analysing data, generating hypotheses, testing hypotheses and generating new ones is ongoing. Analysis is made of "three concurrent flows of activities: data reduction, data display, and conclusion drawing/verification" (Miles & Huberman, 1994, p.10). Therefore everything I started to do after the data collection<sup>13</sup> will be considered as an integral part of the analysis itself.

The general process of analysis was of progressive focussing on emerging trends and issues from the observations, which can partly be described within the framework of *grounded theory* (Glaser & Strauss, 1967), starting from potentially important variables. Glaser & Strauss (1967) have developed a model of generating hypotheses through "grounded theory", i.e. theory which is discovered from systematically obtained and analysed data. Even if at the beginning of my research I did not plan to follow this model, the actual process of analysis emerged as a combination of letting hypotheses emerge from the data (grounded theory) and developing a theoretical explanation on the basis of pre-set theoretical ideas (drawing on the literature discussed in chapters 2 and 3).

The cases selected to be part of the corpus of data for the analysis are outlined in Table 5.5<sup>14</sup>.

---

<sup>13</sup> Given the characteristics of the study, some analysis started during the process of data collection and allowed me to refine the data collection methods in order to gather more appropriate data.

<sup>14</sup> From all the data collected, one case was left out from the corpus of data to be analysed. This decision was based on the idea of "theoretical saturation", that is "the point at which incremental learning is minimal because the researchers are observing phenomena seen before" (Eisenhardt, 2002, p.26).

Case study	Problem	Students	Setting
Case 1. B&T	Perpendicular bisectors of a quadrilateral	Bartolomeo & Tiziana	Italian setting
Case 2. D&G	Perpendicular bisectors of a quadrilateral	Debora & Giulia	Italian setting
Case 3. A&T	Varignon's problem	Alessandra & Tiziana	Italian setting
Case 4. V&M&E	Perpendicular bisectors of a quadrilateral	Valentina & Michela & Elisa	Italian setting
Case 5. A&W	Angle bisectors of a quadrilateral	Alice & Will	English setting

Table 5.5. The corpus of data for the analysis

In the analysis I did not separate the data from the two settings, because the main focus was the analysis of students' processes in the proving process, but no explicit comparison between the two countries was to be carried out<sup>15</sup>.

### 5.7.1 Data reduction

"Data reduction refers to the process of selecting, focusing, simplifying, abstracting, and transforming the data that appear in field-notes or transcriptions" (Miles & Huberman, 1994, p.10). The first thing to do is then to sort the videos, fieldnotes and students' paper work, which for my research purposes should be looked at at the same time. As far as fieldnotes, they were word-processed in order to get a general sense of what had been going on. However they were not actually precise enough to start any analysis with respect to the aims. The students' work was left aside and used later in the analysis.

I started the process of analysis by watching all the videos (six). While watching the videos a first analytical step was taken, in that striking facts or issues, on the basis of a preliminary analytical framework (see section 5.8), were annotated on paper and constituted the starting point for the emergent theory. Transcribing the videos was the subsequent activity, which aimed at making the data available in a suitable form for the analysis. It was decided to transcribe all the videos from the selected case studies, in order to be able to access those data in a directly usable form (going back to the video required too much equipment which was not immediately and daily available<sup>16</sup>). It should not be assumed that the preparation of transcripts is simply a technical detail prior to the main business of the analysis. As

<sup>15</sup> Even if initially the possibility of comparing the English and Italian students in terms of their proving processes was considered, it was not possible to collect the data which this comparison would have required (e.g. detailed information about the students' and schools' background).

<sup>16</sup> However the videos were watched again a couple of times during the analysis, especially when the attention was focused on the analysis of interactions (between the students and between the students and Cabri) or on other elements which are difficult to record in a transcription.

---

Atkinson & Heritage (1984) point out, the production and use of transcripts are essentially 'research activities'. "They involve close, repeated listenings to recordings which often reveal previously unnoted recurring features of the organization of talk" (Silverman, 2000, p.151). "The preparation of a transcript from an audio-tape or a video-tape is a theoretically saturated activity" (Silverman, 2000, p.31), as the researcher has to make choices about how to transcribe and what to transcribe. Moreover, presenting the transcripts in a way which is suitable and useful for the analysis and at the same time understandable for a reader, constituted an ongoing process throughout the research. First, I transcribed from watching the videotapes, writing down both talk<sup>17</sup> and gestures or other activities (only when directly relevant for the analysis). Figures from the Cabri screen were also inserted at relevant moments of the activity. After transcribing, the Italian transcripts were translated in full. Second, I chose the form of organising the transcripts for the analysis and for the presentation. Different forms were tried out and experimented with during the analytical process, suggested by the development of different issues which required different layouts to be displayed. The most useful organisation of the transcripts for the analysis is shown below (Table 5.6). In this form, a table is constructed in which each student is allocated a column (one on the left and one on the right) and a column in the middle is used for the interventions of the teacher or observer or other students. The interventions or actions are written in consecutive lines and numbered. The very left column contains the time sequence of events. This layout allows seeing at a glance the frequency of the interventions of each student, how much the teacher intervened, in what ways the exchanges between the students took place and also it makes it easier to follow the line of arguments related to a particular conjecture/proof. All these things were absolutely relevant for the research aims. Third, each transcript was divided into episodes, that are "distinct students interactions with a clearly identified focus" (Noss & Hoyles, 1996, p.148). The focus was identified as a different kind of activity (e.g. exploring, conjecturing or proving) or as a different 'topic' (e.g. different figures or configurations). All conjectures and proofs made by the students were highlighted in all the different instances in which they appeared in the proving process. Finally, the 'story' of the proving process for all cases was written (see appendixes

---

<sup>17</sup> I did not follow particular transcription rules, because the kind of analysis I wanted to carry out did not require a lot of precision in the transcripts; what was important for me was to have all the talk and actions recorded. The rules I adopted for the transcriptions were: when there was a long silence for more than 1 minute, then this was transcribed as 'silence'; if the students started a sentence but did not finish it (because either they were interrupted by another student or they did not know how to finish it) I put "...". Students' actions are in Normal while students' talk is in *Italics*.

E, F, G and H) as a first “write-up” for each case, which allowed me “to become familiar with each case as a stand-alone entity” (Eisenhardt, 2002).

	Will	Teacher/Observer/Others	Alice
0.14.10	<i>113. Will: two pairs of lines in the middle of the quadrilateral</i>		
	114. Will points at the small square.		
			115. Alice deletes the measure.
		<i>116. Teacher: so both these things are about what pairs of opposite sides are parallel together?</i>	
	<i>117. Will: yeah.</i>		
			<i>118. Alice: so that's a parallelogram now</i>
			119. Alice moves C a small bit, then moves D along the diagonal DB (Figure 5.1).
			 <p>Figure 5.1. A&amp;W, Ep.3, #119</p>

Table 5.6. Example of the layout of a transcript

### 5.7.2 The continual process of analysis

The reading of the transcript, the development of the categories of analysis and the elaboration of an explanatory theory proceeded in a continual process, in which the categories were continuously redefined according to the information emerging from the data. As Miles & Huberman (1994) put it:

You begin with a text, trying out coding categories on it, then moving to identify themes and trends, and then testing hunches and findings, aiming first to delineate the “deep structure” and then to integrate the data into an explanatory framework. In this sense we can speak of “data transformation” as information is condensed, clustered, sorted and linked over time. (p.91)

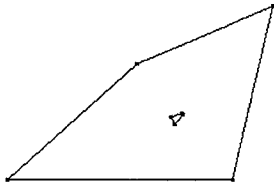
After having transcribed all videos, the process of “data transformation” began with making a decision about the way of analysing them. Two steps were taken: first, an in-depth analysis of the proving process in one case according to a preliminary framework (described in chapter 6), which led to the development of a more complete analytical



framework<sup>18</sup> (discussed in chapter 7), and second, analysis of single episodes in different cases, according to the analytical framework, chosen to illustrate and support theoretical claims constantly developed (see chapters 8 and 9). The process of selection of the transcript to analyse in full detail was not set out at the beginning, but it followed the first step of the analysis (watching all the videos). One transcript was initially chosen on the basis of the fact that interesting issues, which I wanted to further pursue, emerged from it. The case chosen was Case1 -B&T.

First case study (Case 1 –B&T). The process of analysis with the first transcript was the following. 'Reading' the transcript (data), that is highlighting what struck me most, without being too constrained by the starting categories of analysis. New elements emerged as relevant in the proving process. A table of analysis was constructed according to the initial categories of analysis (an example is shown in Table 5.7 and in Appendix D, p.303), leaving space for emerging new elements. From such an analysis, major trends and issues were identified. The categories were redefined, a final decision about the ones to include in the research was made and a final analytical framework was developed.

#	events	statements	dragging	interactions	others
49.	After finishing the Cabri construction B suggests to move the figure. T seems reluctant to do this at first. She seems to pay a lot of attention to the appearance of the figure first. But then she follows what B is saying and starts moving the point D randomly on the screen.	Dynamic	B wants to do dragging (#49-#50).	B has a strategy in mind and wants to move (#49). While T wants to make the figure 'perfect' before moving (#50).	
50.		Dynamic			
51.		dynamic and generative: <i>try to move (#51)</i> : it is the starting point of the exploration.			

Table 5.7. Example of a table of analysis

Other cases. After the analytical framework was specified (chapter 7), the other case studies were analysed according to these categories (chapter 8). Within case and cross case analysis

<sup>18</sup> "Begin the analysis on a relatively small part of your data. Then, having generated a set of categories, you can test out emerging hypotheses by steadily expanding your data corpus" (Silverman, 2000, p.179).

---

was carried out in a process of developing an explanatory model for the proving process occurring in dynamic geometry environments. Similarities and differences with the previous case were observed, following the process of constant comparison (Glaser & Strauss, 1967).

While coding an incident for a category, compare it with the previous incidents in the same and different groups coded in the same category ... This constant comparison of the incidents very soon starts to generate theoretical properties of the category. The analyst starts thinking in terms of the full range of types or continua of the category, its dimensions, the conditions under which it is pronounced or minimised, its major consequences, its relation to other categories, and its other properties. (p.106)

The process of analysis leading to the development of the explanatory framework (chapter 9) was highly iterative, including back and forth moves from one case to another, from building generalisation to looking back at the data; this let new elements and explanations constantly emerge. “The process is alive with tension between divergence into new ways of understanding the data and convergence onto a single theoretical framework” (Eisenhardt, 2002, p.28).

Figure 5.2 illustrates the process of analysis<sup>19</sup>.

---

<sup>19</sup> This structure of the analytical process helped me not to be overwhelmed by the amount of data I had. In fact, after the first transcript was analysed, looking at the others through the analytical framework became much easier and things came up very quickly.

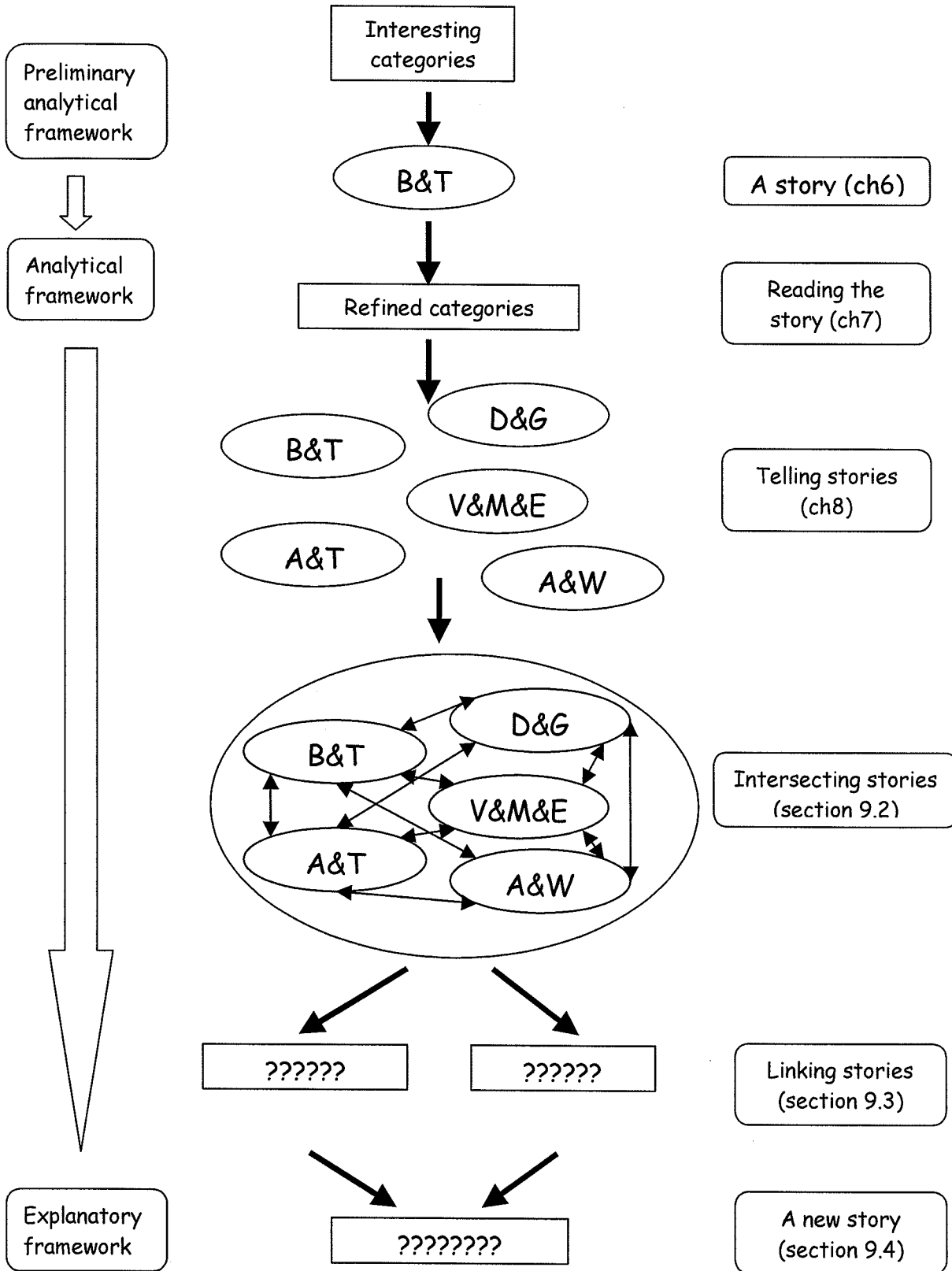

Figure 5.2. The analytical process

## 5.8 A PRELIMINARY ANALYTICAL FRAMEWORK

This section presents the preliminary analytical framework, which was a starting point for the investigation of the research aims of this project (see section 5.1) and for the development of a more specific analytical framework to describe and explain how the proving process occurs in a dynamic geometry environment. I went to the field with an idea of what I wanted to observe and how I was going to observe it. So I had in mind broad categories which to look at the data through, but I was open to let other things emerge from the data. This preliminary framework was based on different inputs: the existing literature (chapters 2 and 3), observations from an exploratory study (section 5.2), a previous study (see section 3.4.4) and new observations (see chapter 6). All these inputs guided the choices with respect to which elements to observe within the richness of the learning situation, taking into account the two main aims of the project (which concern the development of conjectures and proofs in the proving process, and the interactions taking place in the proving process). The starting point (see section 5.8.1) was the model previously developed by Arzarello et al. (1998a) and Olivero (1998; 1999). This model identified different dragging modalities students use when tackling open geometry problems and provided a cognitive explanation for their use. Dragging however is only one of the tools available to students while solving the problems and the interaction of students with dragging is only one of the interactions taking place during the proving process, as it emerged from the exploratory study. Therefore other potentially important elements of analysis (see section 5.8.2) were identified a priori, i.e. before going into the main fieldwork, either from the exploratory study or from the theoretical assumptions and literature. Starting from these general categories of analysis, a first scan of all data available was done and new interesting categories of investigation, which had not been taken into consideration before, emerged (see section 5.8.3).

### 5.8.1 The starting point: a categorisation of dragging modalities

Many tools are available within the Cabri environment. In a previous study I chose to single out the main aspect that makes it different from a paper and pencil environment: the dragging function. In the analysis of the dragging function, a number of modalities were

identified in a previous study (Olivero, 1998) and refined over time according to new observations (Olivero, 1999). The modalities are described below in Table 5.8<sup>20</sup>.

<b>DRAGGING MODALITY</b>	<b>Description</b>
<b>Non dragging</b>	Not moving anything on the screen.
<b>Dragging test</b>	Moving draggable or semi-dragable <sup>21</sup> points in order to see whether the figure keeps the intended properties.
<b>Wandering dragging</b>	Moving the basic points on the screen randomly in order to discover configurations or regularities in the figures.
<b>Bound dragging</b>	Moving a semi-dragable point, which is constrained to move on a constructed object (e.g. a point on a circle).
<b>Guided dragging</b>	Dragging the basic points of a figure in order to give it a particular shape.
<b>Lieu muet dragging<sup>22</sup></b>	Moving a basic point so that the figure keeps a discovered property; that means you are following a hidden path (lieu muet), even without being aware of this.
<b>Line dragging</b>	Drawing new points on the ones that keep the regularity of the figure.
<b>Linked dragging</b>	Linking a point to an object and moving it onto that object.

Table 5.8. Dragging modalities

However, the analysis of transcripts showed that not only what appears at the interface when students are using Cabri is relevant but also where students appear to be focusing their attention on while dragging during the proving process, so that this dragging model required refinement.

### 5.8.2 A priori categories of analysis

The framework for dragging was taken as a starting point, but the use of other tools and interactions in the process needed to be studied in order to formulate a more general picture of what the proving process is like in a dynamic geometry environment. So the following categories of analysis were identified.

**The use of paper sketches.** The students observed were always given the possibility of using paper. The exploratory study had already shown the need for a deeper investigation of the use of paper and pencil (see section 5.2). The way and the moments

<sup>20</sup> Examples for each dragging modality will be presented in the following chapter, in the description of the complete analytical framework (chapter 7 – see section 7.3.1).

<sup>21</sup> Draggable points are the free points, that is the ones which are constructed using the menu 'point'. Semi-dragable points are points on objects, that can move only on that object (e.g. points on a circle).

<sup>22</sup> The word already used in literature in *mou* (Laborde, 1995), i.e. soft, but I preferred to use *muet*, i.e. dummy, so to underline the fact that you do not know which way the path is going.

in which students decide (if they do) to use paper may be a key point in the development of the proving process.

**Types of statements.** In chapter 2 (see section 2.6, p.41), the *proving process* was defined as the process of finding and entering a relationship of the kind 'B follows from A', until the agents involved (in this case, the students) are satisfied with the explanation for the truth of the statement; this explanation is a proof if it satisfies the rules of logical consequence. According to this definition, the production of conditional statements, is a key point towards the development of proving. "If properties of figures are not conceived as dependent, a deductive reasoning has no meaning" (Laborde, 2000, p.157). Therefore, the evolution of the different statements produced over the process, which leads to the final de-timed conditional form of the conjecture 'if ... then', became an object of study.

**Interactions between the students.** An important element of the proving process is the relationship between internal and external contexts<sup>23</sup> of action. The internal context is what is and happens in the mind of the students, while the external context is what is produced and visible (as for example Cabri figures, statements, etc). When there are two (or more) students solving the problem at the computer, everyone has his/her own internal context, which has to be externalised in order for interaction to take place. The construction of a Joint Problem Space (Teasley & Roschelle, 1993) is then considered important as it may either support or get in the way of the evolution of the proving process.

**Interplay between the spatio-graphical field and the theoretical field.** When tackling an open geometry problem, two fields are available to students: the theoretical field and the spatio-graphical field. The Theoretical field (T) refers to theorems, definitions, properties and their deductive structure within geometry (Laborde, 1998). The Spatio-Graphical field (SG) includes figures, drawings, sketches (Laborde, 1998). Since Cabri figures embody both graphical and theoretical elements (as discussed in section 3.4.2), the way students make use of these two different fields towards the construction of conjectures and proofs is revealed to be particularly interesting in this context.

---

<sup>23</sup> What I call internal context is what Edwards & Mercer (1987) define as context: "We shall use the term *context* to refer to everything that the participants in a conversation know and understand, over and above that which is explicit in what they say, that contributes to how they make sense of what is said" (p.63).

---

### 5.8.3 New categories emerged from the data

While scanning through all transcripts, some other elements came up quite vividly as interesting moves in the proving process, as listed below.

**The use of construction elements.** Besides dragging, it emerged from the data that the use of construction elements in Cabri plays a fundamental role. In fact, Cabri allows a broad flexibility with the use of construction lines, which can be added, deleted, hidden and shown. The way students deal with these possibilities has an impact on the proving process. Research on the use of constructions as a means to foster theoretical thinking has been carried out (see Mariotti, 1996), however the use of constructions within problems which are not necessarily focused on constructions has not yet been tackled.

**Interactions between students and Cabri.** The way the students exploit and incorporate the computer in their solution strategies in general, through the use of dragging, of constructions and by talking, was observed to be relevant for the development of the proving process. Differences between students and between different phases of the process were observed and required an explanation.

Figure 5.3 shows this preliminary analytical framework, in which the hierarchy of categories is based on how those categories may be observed in the investigated setting. Categories which can be directly observed, by looking at what students do on the Cabri screen or on paper and what students write or say, are: the use of dragging, the use of constructions, the use of paper sketches and the types of statements produced. Categories which can be observed through the previously listed ones are: the interactions between students and Cabri and the interactions between students. In fact these ones depend on how students do dragging, use constructions, do sketches and the statements they produce. At a top level is the interplay between the spatio-graphical field and the theoretical field, which can be tracked by looking at all the previously listed categories.

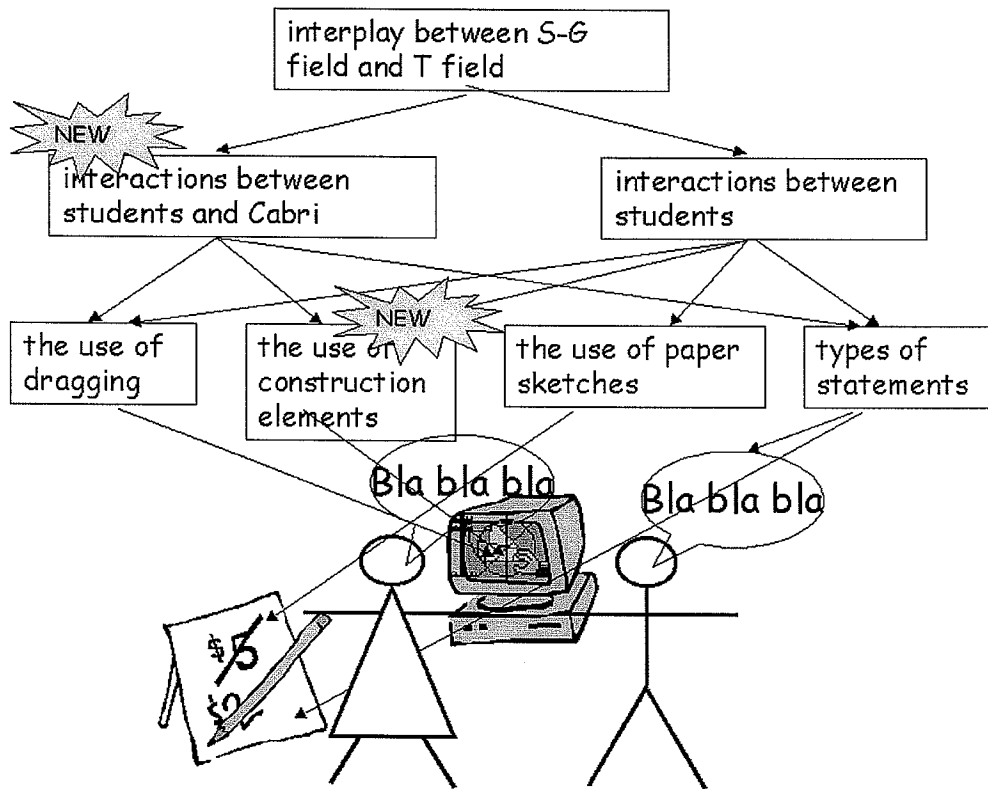

Figure 5.3. A preliminary analytical framework

## 5.9 RELIABILITY, VALIDITY AND GENERALISABILITY

This research is a qualitative study of case studies of pairs of students in multiple classroom settings, in which a process of theory building takes place.

“Validity is a measure of the extent to which you are measuring what you think you are measuring” (Brown & Dowling, 1998, p.26). The validity of this type of research is granted by the fact that “the theory-building process is so intimately tied with evidence that it is very likely that the resultant theory will be consistent with empirical observation” (Eisenhardt, 2002, p.29). The way the research process developed, with a constant interplay between generating a theory and looking at the data, should establish the “validity” of the study. The following chapter (chapter 6) will provide an account of how the analytical and explanatory frameworks were generated starting from the observation of data, so that the reader will be able to see how validity was constructed.

“Reliability is a measure of the consistency of a coding process when carried out on different occasions and/or by different researchers” (Brown & Dowling, 1998, p.26). Reliability was obtained by the variety of settings observed and the presence of more than one researcher in the observation process.



---

“Case study theory building is a bottom-up approach such that the specifics of data produce the generalization (sic) of theory. [...] They are essentially theories about specific phenomena” (Eisenhardt, 2002, p.30). The “theory” constructed in this study consists of an analytical and explanatory framework describing the proving process and the interactions taking place within a dynamic geometry environment. The theoretical explanations for the observed behaviours provide generality but I am aware of the specificity of the setting and process observed. A balance between the details of the data and the generality of the theory being constructed was attempted throughout the research process.

## **5.10 ETHICAL ISSUES**

Two main ethical issues were taken into account:

- informing the participants;
- using and displaying data.

All participants in the research (students and teachers) were informed of the fact that they were part of a research project for my PhD and they all gave their consent to be part of it. In two classrooms in Italy the students were used to having external observers in the classroom, given that they were part of a project with the University. In general, the students were not disturbed by the use of the video camera or by the presence of observers in the classroom.

As far as the use of data to be presented in papers and conferences, I obtained the consent from the parents of the Italian students and of the students in the English setting. Also the teachers and the schools were happy to be mentioned in presentations of the research. Therefore the names of students and schools used in this thesis are the original ones.

## **5.11 THE OVERALL RESEARCH PROCESS**

Figure 5.4 represents the whole research process which is characterised by a continuous interaction between theory and data.

- A model describing the phases of the proving process for students working within dynamic geometry environment was the starting point. Cabri was seen as a possible support to enable students to do the things experts normally do, because of the dragging function (see section 2.5.3, p.40 and 3.4.4, p.66).
- This model was then used to plan and observe a classroom experiment in England (the exploratory study- see section 5.2 and (Olivero, 2001). Results from this study and a

new literature review provided elements showing the need to refine and add elements to the initial model. A re-thinking of the model began: the process in Cabri is not that simple as the previous model was showing. New research aims were stated. At the same time methodological suggestions were drawn (e.g. what kind of data need to be collected to investigate these new elements, what is missing in the videos) and then used in other classroom observations.

- Other classroom observations were carried out within multiple classroom interventions (in an English and an Italian setting). The data and the theory informed each other throughout the whole research process, in order to illuminate the construction of a new explanatory framework. The literature was constantly reviewed and new perspectives taken on board.
- The final goal was to come up with an explanatory framework, that is a detailed description and interpretation of students' proving processes within a dynamic geometry environment, which elaborates all the elements which are coming up from the analysis and provides answers to the formulated research questions.

Starting from the preliminary analytical framework presented in this chapter, the analysis of one transcript is presented in the following chapter (chapter 6). Specifications for each of these categories emerged and contributed to the development of an expanded analytical framework (chapter 7) and to highlight the particular focus of this research.

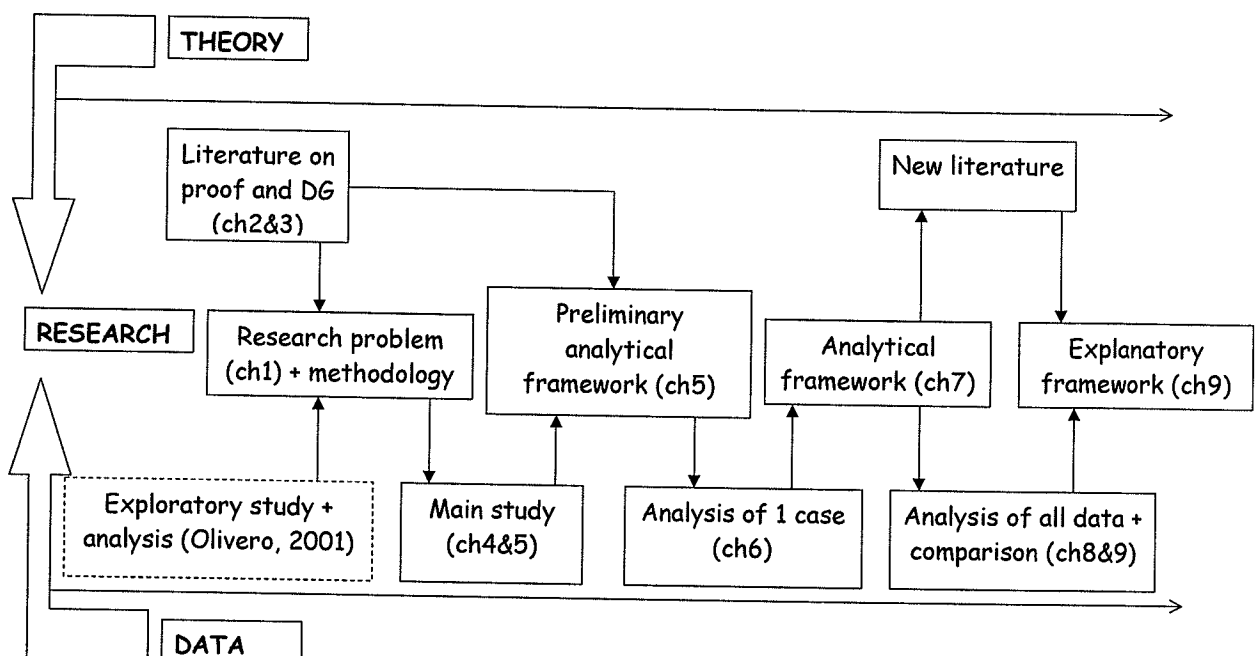

Figure 5.4. The research process

---

## CHAPTER 6. THE STORY OF BARTOLOMEO AND TIZIANA

*Bartolomeo: so, wait, if this is a right angle I can say that...*

*Tiziana: no, but it's not a right angle, what are you talking about? So ...*

*Bartolomeo: ... it must be, otherwise they are not parallel*

*Bartolomeo: ... so... let's do this... but look, here there are four right angles,  
otherwise they are not parallel*

*Tiziana: oh dear, look!... the perpendicular bisector, isn't it? There is always a right angle!*

*(Bartolomeo & Tiziana, 15 year old students, Italy)*

### 6.1 INTRODUCTION

Usually it is hard to explain something satisfactorily until you understand just what the something is. Thus a natural progression, as Rein & Schon (1977) suggest, is from **telling a first “story”** about a specified situation (what happened, and then what happened?), to constructing a “map” (formalizing the elements of the story, locating key variables), to building a theory or model (how the variables are connected, how they influence each other). (Miles & Huberman, 1994, p.91)

This chapter tells the “story” of Bartolomeo and Tiziana (case 1 - this case will be abbreviated as B&T where necessary) and their proving process while solving the problem Perpendicular bisectors of a quadrilateral. This is to be the first step of the “natural progression” mentioned above, which will continue in the next three chapters: chapter 7 involves constructing a “map” or analytical framework and chapters 8 and 9 involve building a “model” or explanatory framework.

The chapter is divided into four sections. The first section briefly sketches the context of the case study. The second section reports the development of the proving process, divided into episodes. The third section tells the story of the proving process from the point of view

of the broad categories of the analytical framework outlined in chapter 5<sup>1</sup> (section 5.8). Finally the key elements of this story are set out and lead into the construction of the analytical framework presented in chapter 7.

## 6.2 THE CONTEXT

Bartolomeo and Tiziana are 15-year-old students from a second year classroom of a Liceo Scientifico in Turin (Italy)<sup>2</sup>. They are medium achievers with respect to mathematics. They had already used Cabri some times before this session, working on construction and exploration problems. The problem given to the students was: Perpendicular bisectors of a quadrilateral (Figure 6.1). The session took place on the 16<sup>th</sup> February 2000.

You are given a quadrilateral ABCD. Construct the perpendicular bisectors of its sides: a of AB, b of BC, c of CD, d of DA. H is the intersection point of a and b, K of b and c, L of c and d, M of a and d.

Investigate how HKLM changes in relation to ABCD.

Prove your conjectures.

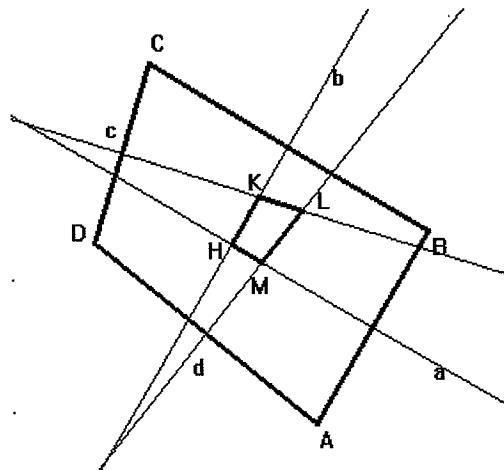

Figure 6.1. B&T. Perpendicular bisectors of a quadrilateral

The students were presented with the problem and asked to formulate conjectures and try to prove them. They were given a worksheet with the statement of the problem and were required to write the conjectures down and possibly proofs. The session lasted 1 hour and 45 minutes. The teacher was left free to intervene, but she never did. The observer intervened a couple of times: once when the students appeared to be stuck on one particular

<sup>1</sup> The broad categories of analysis are the following: the use of dragging, the use of construction elements, the use of sketches, types of statements, interactions between the students and Cabri, interactions between the students, interplay between the spatio-graphical field and the theoretical field.

<sup>2</sup> For a detailed description of the context of the Italian setting see chapter 4 (section 4.3).

configuration and she suggested that they moved on to something else, and a second time to suggest that the students went back to an interesting configuration they had abandoned.

### 6.3 THE PROVING PROCESS OF BARTOLOMEO AND TIZIANA

This section presents the story of the solution process the students undertook, divided into episodes, which summarise activities of the same kind. The construction of conjectures and proofs will be described as they were discovered, formulated and written down. The conjectures are numbered in order of appearance as C1, C2 etc. and so are the proofs (P1 is the proof for C1, P2 for C2 and so on). All the statements which are a different formulation for conjecture Cn are named Cn. The numbers n refer to lines in the transcript, which is attached in Appendix C (p.268). The description of the events is in normal Times. *The students' talk is in Italics.* The written statements are in Courier font.

#### 6.3.1 Episode 1. Constructing the figure

(#1-#48, time: 0.00.00-0.05.03)

The first five minutes of the session are dedicated to the construction of the two quadrilaterals ABCD and HKLM (Figure 6.2). Then Bartolomeo reads the statement of the problem (47).

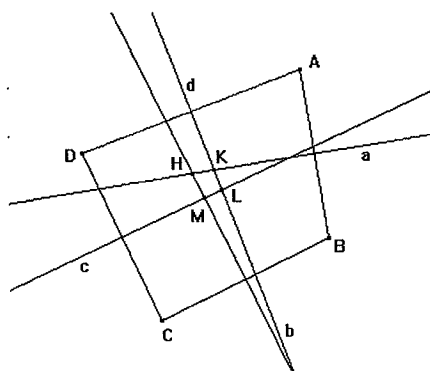

Figure 6.2. B&T, Ep.1, #46

#### 6.3.2 Episode 2. Starting to explore. Formulating a conjecture about the parallelogram (C1)

(#49-# 68, time: 0.05.04 - 0.07.03)

After finishing the Cabri construction, Bartolomeo suggests moving the figure: *try to move (51)*. Tiziana seems reluctant to do this at first. But then she follows what Bartolomeo is saying and starts moving point D, after having hidden the construction lines (56). Bartolomeo suggests exploring and seeing *what happens in every case (60)*, starting with a trapezium: *try to make it a trapezium (57)*. Tiziana instead drags the quadrilateral into a parallelogram (Figure 6.3).

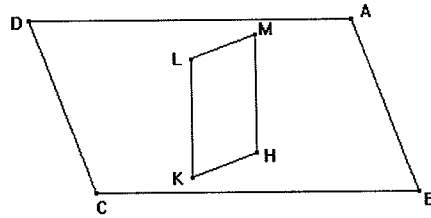

Figure 6.3. B&amp;T, Ep.2, #64

The first conjecture **C1** is formulated as *if this is a parallelogram then this is a parallelogram too* (65) and written down: if ABCD is a parallelogram then HKLM is a parallelogram too (68). As soon as they formulate the conjecture about the parallelogram, Bartolomeo says that *then we need to prove it of course* (67).

**C1**<sup>3</sup>

### 6.3.3 Episode 3. Exploring the case of the point (C2) and the case of the trapezium (C3)

(#69 - #111, time: 0.07.04 – 0.13.00)

Meanwhile Tiziana drags ABCD so that it is a rectangle (Figure 6.4).

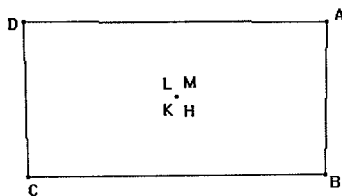

Figure 6.4. B&amp;T, Ep.3, #69

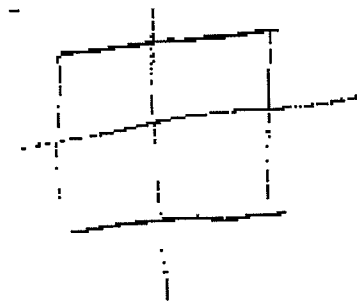

Figure 6.5. B&amp;T, Ep.3, #93

From 69 to 93 they explore the case when there is a point inside, and Bartolomeo formulates the conjecture for the rectangle, **C2**: *When it's a rectangle it is always a point* (79), which he writes down, asking whether he should write *disappear* or *it's a point*. The conjecture is then reformulated as *if it is a rectangle it is a point* (81-C2). Bartolomeo writes down his conjecture (81), which Tiziana then says again in 90. A proof for that is seen in a paper sketch that Tiziana makes (Figure 6.5 - 93).

**C2**

Incidentally, Tiziana observes (80) that there are other positions for which H, K, L and M coincide. But Bartolomeo does not pay attention to this, so that the conjecture is not generalised.

**C7**

While exploring the case of the point, there are two detours around other configurations. First, Tiziana notices some relationships between the sides of the two quadrilaterals: *This* (she points at LM) *follows what this* (AB) *does, this* (LK) *follows this* (AD) ... (76 - Figure 6.6). She keeps concentrating on it in this episode (96, 101-109) and later in the process, discovering the more general conjecture about ABCD and HKLM being similar (see conjecture **C8**, Episode 7). Second, Bartolomeo wants to do the case of the kite (85), which however is abandoned to go back to the rectangle-square case.

**C8**

<sup>3</sup> This column on the right marks the conjectures and all the incidences which will bring to future conjectures. For example when I write C1 it can be that the conjecture C1 formulated at that moment or that the students are working on something related to conjecture C1. This should help the reader to follow the evolution and production of conjectures and proofs throughout the process.

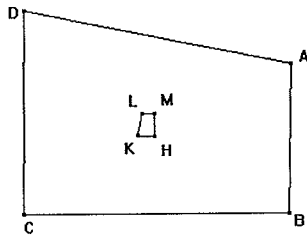

Figure 6.6. B&T, Ep.3, #76

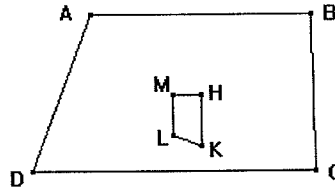

Figure 6.7. B&T, Ep.3, #97

After this Bartolomeo goes back to the parallelogram case (94) making ABCD a parallelogram on the screen and he reminds himself of the conjecture C1 they wrote before (95). Then Bartolomeo concentrates on another figure, the trapezium (97- Figure 6.7), and formulates conjecture C3: *try to make it a trapezium (97) ...it becomes a trapezium too (100).*

C1

C3

### 6.3.4 Episode 4. Proving the case of the parallelogram (P1)

(#112 - # 197, time: 0.13.01 – 0.34.49)

#### a. Wanting to prove conjecture C1

Bartolomeo goes back to the case of the parallelogram again (C1 - 112). He knows they have to prove their conjectures (112). After having a figure on the screen which is a parallelogram<sup>4</sup>, they start proving that HKLM is a parallelogram (118). The declaration *we must prove that it is a parallelogram* (119) provokes silence.

P1

#### b. Summarising conjectures and detour on another conjecture about the rhombus (C4)

Before starting to prove C1, Bartolomeo makes a summary in words of all the conjectures they made up until this point (C1, C2 and C3), formulates a new one (123) about the rhombus: *then, if this is a rhombus? That one is a rhombus too (C4)*, and then writes it down: *if ABCD is a rhombus then HKLM is a rhombus (124 – C4).*

C1

C2

C3

C4

#### c. Bartolomeo tries proving conjecture C1 (P1)

Bartolomeo says again that now they have to prove the case of the parallelogram (C1) because he thinks it is the easiest (125). He makes the bisectors visible and transforms the thesis (HKLM parallelogram) into a property of the parallelogram (lines parallel - 127), so that they can get started. He wants to prove that two opposite sides of HKLM are equal (131). In 136 Bartolomeo explains the line of the proof he is thinking about. It centres on proving that KL and HM are parallel by using a theorem about the internal angles of parallel lines. He draws the diagonal HL and marks the internal alternate angles (137 - Figure 6.8).

P1

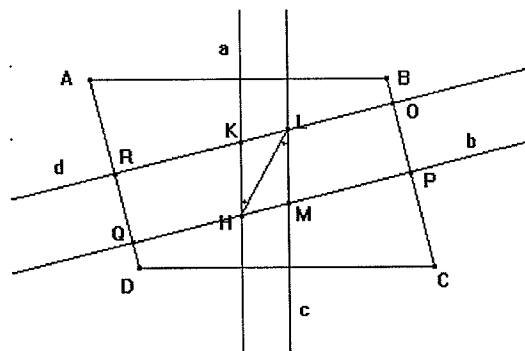

Figure 6.8. B&T, Ep.4, #137

Bartolomeo sees that Cabri marks those angles with equal marks, but he is aware that they have to prove that those angles are actually equal (138). There is a first step towards the proof: *since*

<sup>4</sup> They obtain this parallelogram by drawing a line going through A and parallel to BC and then moving D on that line. And this constitutes a validation for them. There is no actual geometrical construction.

they (angles MLK and LHK) are equal then HM and KL are parallel (138). About 30 seconds of silence. Then Bartolomeo says *so we know it's true but we should prove it* (149). Another bit is added: *well, we can prove that HLM, this triangle, equals that one* (he points at the triangle KLH with the mouse), *so if they will be equal, the angles in L and in H will be equal too; so these are parallel* (points at KL and HM), *is that right?* (149). About 45 seconds of silence. The perpendicular bisectors are mentioned for the first time, but only as lines, not mentioning their property of being perpendicular to the sides (153). After some reasoning on the angles formed by H, K, L and M and the perpendicular bisectors b and d, Bartolomeo thinks he has proved the conjecture (163) but Tiziana tells him that he has taken for granted the thesis (parallelism of KL and HM) (162-164).

#### d. Tiziana proves conjecture C1 (P1)

They start again from considering what they can see on the screen and what they know: ABCD is a parallelogram (165 - Figure 6.8). Tiziana adds a bit of justification: *because you constructed it* (166). Bartolomeo notices that b and d are parallel (167). Tiziana notices the midpoints of BC and AD (168), then she says that *if AD and BC were parallel ...*(172). Bartolomeo observes that those two segments are actually parallel, so b is the transversal line and the equality of internal opposite angles (BPQ=OQP and BOR=DRO) is noticed (173). Bartolomeo is thinking that *if this is a right angle (BPQ)...* (175). Tiziana says *but it's not a right angle* (176). Bartolomeo reacts: *it must be, otherwise they are not parallel* (b and d) (177). Tiziana summarises: parallel sides AD and BC and midpoints R and P. The intervention in 181 is a proof for Tiziana, even if she did not use the property of the perpendicular bisectors: *now, since these are parallel, this angle here* (points at CPQ) *equals that angle there* (AQP). *Then, this angle here* (COR) *equals that angle there* (ORA), *so they are... correspondent* (points at angles PQA and ORA); *therefore this and this are parallel* (points at d and b)... *I made it!* (181).

P1

#### e. Tiziana explains her proof P1 to Bartolomeo

Bartolomeo is asking for explanation about the proof Tiziana has just done (184). Right angles are mentioned again by Bartolomeo (192). Finally Tiziana mentions the perpendicular bisector and the property of having right angles (193). This is the key fact that allows them to construct the proof. The proof P1 of conjecture C1 is in lines (194-196). *Bartolomeo: I see! How stupid we are! So, therefore, this is right angle, and this one too...and these are right angles. Therefore if it is right angle, they are parallel. Tiziana: so this equals this... Bartolomeo: they are parallel, ok, fine till now.*

P1

### 6.3.5 Episode 5. The case of the rhombus (C4)

(#198 - #213, time: 0.34.50 – 0.36.00)

Bartolomeo wants to consider the rhombus (C4), but they only manage to make ABCD look like a rhombus, then there is a 15 minutes break.

C4

### 6.3.6 Episode 6. Proving the case of the point inside (C2)

(#214 - #227, time: 0.36.01 – 0.38.56)

They go back to conjecture C2 they made in 69, generalising it to a square. Bartolomeo constructs the proof P2, looking at Figure 6.9: *so since this is the midpoint* (points at the midpoint of AB) *this bit equals that bit* (points at the parts in which AB is divided by its perpendicular bisector) *and so also this one equals that one* (repeats the same thing about the two halves of CD) ... *yes...and so they meet at one point only* (points at HKLM), *because anyway the perpendicular bisectors... since this goes through the midpoint* (points with the mouse at the midpoints of AB and CD)... *the two midpoints are connected by a line parallel to the sides...*(points at BC and AD) ... *therefore the two perpendicular bisectors coincide ... So we proved it... it must be!* (216 - 226). Tiziana follows what he is saying and agrees.

C2  
P2



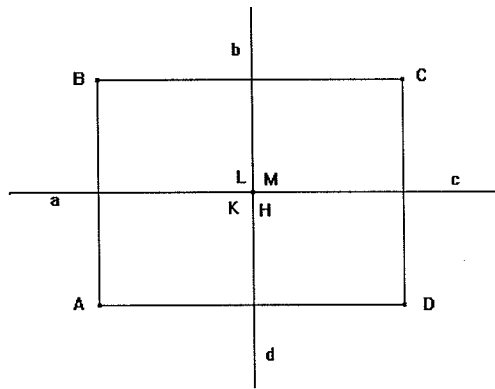

Figure 6.9. B&T, Ep.6, #214

### 6.3.7 Episode 7. Exploring and proving the case of the right-angled trapezium (C5 & P5) and the case of similar quadrilaterals (C8)

(#228 - # 349, time: 0.39.00 – 1.06.00)

#### a. Discovering and proving C5

Tiziana wants to do the trapezium (229) and suggests: *Make it right-angled!* Bartolomeo makes a conjecture about the right-angled trapezium (233): *so another trapezium is formed (C5)*. They start proving it and Bartolomeo constructs a proof very quickly in 247: *that's easy. These are perpendicular (points with the mouse at the line through HK and at b), these being parallel (points at BC and at a, which is the line through HK)... this is a perpendicular (points at b) and so here (in H) a right angle is formed ... proven. Ok, so we proved it's a trapezium ... that it's isosceles, hem, yes, right-angled...* (P5).

C5

P5

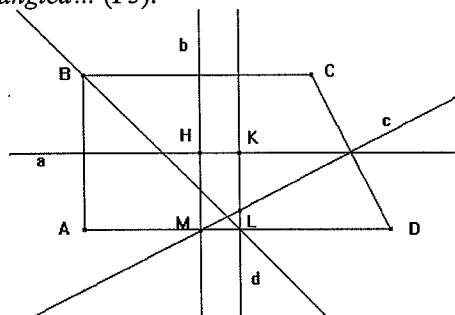

Figure 6.10. B&T, Ep.7, #230

#### b. Trying to prove C8

At the same time Bartolomeo says that *they seem similar (247)*, as he had said in 241, which echoes the observations Tiziana had made before about the corresponding sides in Episode 3. He wants to prove it and has got the idea of how to do it: *We must prove that (247).. it should be...the ratio of BA to HK is the same as the ratio of AD to HM... (250), the ratio of BC to KL, is the same as... the ratio of CD to LH...(252)*. However the proof goes on from 250 to 348, without success. In the proof they add/delete many construction elements in the Cabri figure. At some point the observer suggests that they do another case.

C8

P8

### 6.3.8 Episode 8. Exploring and proving the case of the isosceles trapezium (C6) and the case of the rhombus (C4)

(#350 - #462, time: 1.06.05 – 1.24.36)

Bartolomeo opens a new file and draws a quadrilateral (352).

#### a. The case of the isosceles trapezium (C6)

Tiziana suggests exploring the isosceles trapezium (353 - Figure 6.11).

C6

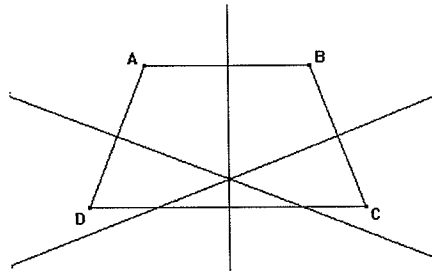

Figure 6.11. B&T, Ep.8, #356

Bartolomeo in 360 observes that *And a point is formed* (when it is an isosceles trapezium), and then transforms it into conjecture a (362): *if it is isosceles the points coincide anyway* (C6).

**b. Tiziana is exploring something new towards the general conjecture about cyclic quadrilaterals (C7)**

A new exploration begins in 364, which is leading to the general conjecture. The first hint for a more general conjecture was in Episode 3: *Tiziana: no, because now it's a point too* (80- when she dragged B so that ABCD was not a rectangle, but HKLM was still a point). Tiziana draws a quadrilateral and then wants to put a circle going through its vertices (364-390), but does not succeed. When being asked by Bartolomeo what she is trying to do (379), she cannot answer.

C7

**c. The case of the rhombus (C4)**

Bartolomeo goes back to the rhombus and wants to prove this case (396 - C4). Tiziana wants to go back to the trapezium (401- C6), but Bartolomeo goes on with the rhombus – C4. Trying to make the figure look like a rhombus takes some time, but he finally manages to do that (434). In 440 the conjecture C4 is reformulated: *so a rhombus is formed*. It had already been written down in Episode 4. Tiziana draws a sketch on paper (441 - Figure 6.12).

C4

C6

C4

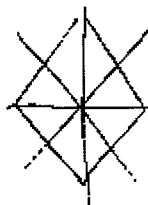

Figure 6.12. B&T, Ep.8, #441

**d. Proving the case of the rhombus (P4)**

In 450-458 they think they have proven the case of the rhombus, although this is not the case. *Bartolomeo: ... this is an isosceles triangle* (points at triangle LKM), *because if this (LM) equals that (KL)... so we proved that that one is a rhombus ...* (P4).

P4

**6.3.9 Episode 9. Formulating of a general conjecture about cyclic quadrilaterals (C7)**

(#463 - #517, time: 1.24.40 – 1.31.00)

The observer suggests that they go back to the figure where the perpendicular bisectors meet at a point, as Tiziana says it is *the one about the circle* (481). They make a summary of what they have conjectured and proven till now (491-492). *Bartolomeo: No, we proved that if it is a rectangle or a square the perpendicular bisectors meet at a point: if it is a parallelogram or a trapezium or a rhombus ... depending on ... Tiziana: if it is an isosceles trapezium... if the trapezium is isosceles, they meet at a point again* (P2, P1, C6). Tiziana is doing something in Cabri, trying to draw four points on a circle (494). Bartolomeo asks her what she wants to do: *a trapezium? A quadrilateral?* (495). Then he constructs a cyclic quadrilateral and its bisectors

C7

P1

P2

C6

C7

(498 - Figure 6.13) and Tiziana immediately observes: *When the quadrilateral is cyclic the things meet at a point* (499 – C7) and Bartolomeo says that: *yes, the perpendicular bisectors meet at a point ... but now we should prove it: this is the worst part* (500). They work on this conjecture from 502 to 511, when in 511 Tiziana reformulates C7: *the sum of the opposite angles equals 180 ...the perpendicular bisectors meet at a point* (511). Bartolomeo observes that square and rectangle (C2) are particular cases of C7: *in fact also the rectangle and the square the sum of the opposite angles is 180* (512).

C7

C2

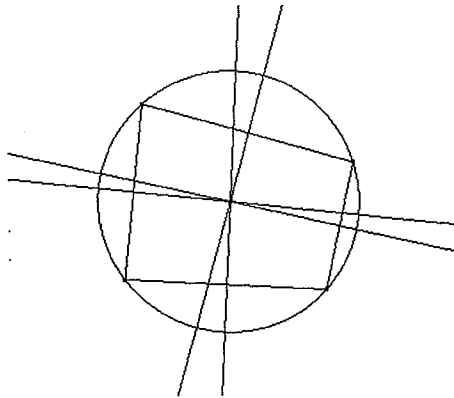

Figure 6.13. B&T, Ep.9, #498

### 6.3.10 Episode 10. Concluding with a general conjecture (C9)

(#518 - #574, time: 1.32.00 – 1.45.00)

Bartolomeo says again C7 in 519. Then in 527 they summarise all their discoveries, by formulating a general conjecture C9= C7+C8. *Bartolomeo: I wanted to see something: that if the sum of the opposite angles we said is 180, then the perpendicular bisectors meet at a point; if on the contrary the sum is not 180, an equal quadrilateral appears...* *Tiziana: not equal, similar!* *Bartolomeo: eh, similar to the given one!* C8 is: *if the sum of opposite angles is different from 180, then there is a figure similar to the given one* as reformulated in 542. After some exploration which shows that the quadrilaterals are always similar (for example Figure 6.14), in 544 Bartolomeo realises that they must prove that in every case they are similar (C8). In 551 they recollect they have proven the parallelogram case (P1). They write down the last general conjecture C9.

C7

C9

C8

P1

C9

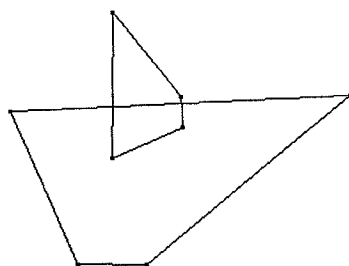

Figure 6.14. B&T, Ep.10, #534

At the end they hand in the following worksheets (Figure 6.15 and Figure 6.16).

**B-T**

the problem

**Esercitazione in laboratorio, 16-2-2000**

Sia dato un quadrilatero ABCD. Tracciate gli assi  $a$  del lato AB,  $b$  del lato BC,  $c$  del lato CD,  $d$  del lato DA. Sia H il punto di incontro degli assi  $a$  e  $b$ , K il punto di incontro di  $a$  e  $d$ , L il punto di incontro di  $c$  e  $d$ , M il punto di incontro di  $c$  e  $b$ . Studiare come varia HKLM al variare di ABCD. Dimostrate le congetture prodotte durante l'esplorazione fatta in Cabri.

1) Se ABCD è un parallelogramma allora anche HKLM è un parallelogramma degli assi

2) Se " è un rettangolo allora HKLM è un punto  
con il movimento in un quadrilatero non c'è un punto fisso

3) Se " è un rombo allora anche HKLM è un rombo

4) Se " è un trapezio " " è un trapezio  
ma se è isoscele si incontrano in un punto

$\hat{K} = \hat{KHM}$   
 $\hat{H} = \hat{LKH}$

$\hat{LKH} + \hat{KHM} = 180^\circ$

1) If ABCD is a parallelogram then HKLM is a parallelogram too right angles

2) If " is a rectangle then HKLM is a point square perp. bis. meet at a point

3) If " is a rhombus then HKLM is a rhombus too

4) If " is a trapezium " " is a trapezium " but if it is isosceles they meet at a point

BA: HK = AD: HM = BC: KL = CD: LH

$\hat{BAD} = \hat{HAM} = 90^\circ$

$\hat{ABB} = \hat{HKN}$  perché  $\hat{BKN} = 90^\circ$   
 $\hat{B} = 90^\circ$

$\hat{CBD} = \hat{BKH}$  perché angoli alterni interni

because internal alternate angles

$\hat{HKN} = \hat{ABB}$

$\hat{MKL} = \hat{CBD}$  perché  $\hat{B}$  e  $\hat{K} = 90^\circ$  formati da angoli uguali

because composed of equal angles

Figure 6.15. B&T. Written work (1)

Esercitazione in laboratorio, 16 - 2 - 2000

Sia dato un quadrilatero ABCD. Tracciate gli assi  $a$  del lato AB,  $b$  del lato BC,  $c$  del lato CD,  $d$  del lato DA. Sia H il punto di incontro degli assi  $a$  e  $b$ , K il punto di incontro di  $a$  e  $d$ , L il punto di incontro di  $c$  e  $d$ , M il punto di incontro di  $c$  e  $b$ . Studiare come varia HKLM al variare di ABCD. Dimostrate le congetture prodotte durante l'esplorazione fatta in Cabri.



$AB \rightarrow a$   
 $BC \rightarrow b$   
 $CD \rightarrow c$   
 $DA \rightarrow d$

- 1) If the sum of opposite angles =  $180 \Rightarrow$  the perpendicular bisectors meet at a point
- 2) If the sum of opposite angles  $\neq 180 \Rightarrow$  you have a figure similar to the first one

- 1) Se la somma degli angoli opposti =  $180^\circ \Rightarrow$  gli assi si incontrano in un unico punto
- 2) Se la somma degli angoli opposti  $\neq 180^\circ \Rightarrow$  si ha una figura simile a quella di prima

- 1) Dimostrazione con un rettangolo e con un quadrilatero inscritto
- 2) Dimostrazione con il parallelogramma

- 1) Proof for a rectangle and a cyclic quadrilateral
- 2) Proof for the parallelogram

Figure 6.16. B&T. Written work (2)

### 6.3.11 Summary of conjectures and proofs

Table 6.1 summarises the conjectures and proofs made by Bartolomeo and Tiziana. The numbers # refer to the lines in the transcript where the conjecture or proof was being constructed.

Conjectures	# <sup>5</sup>	Proofs	#
<b>C1<sup>6</sup></b> If ABCD parallelogram, then HKLM parallelogram	65, 68, 95	<b>P1</b>	112-119, 125-190, 192-197
<b>C2</b> If ABCD rectangle, then HKLM point	70, 81, 91, 123, 214-215	<b>P2</b>	216-226
<b>C3</b> If ABCD trapezium, then HKLM trapezium	97-100, 123, 124	<b>P3</b>	No proof
<b>C4</b> If ABCD rhombus, then HKLM rhombus	123, 124, 211, 431, 440, 446	<b>P4</b>	450-458 (proof attempted but not finished)
<b>C5</b> If ABCD right-angled trapezium, then HKLM right-angled trapezium	231-233	<b>P5</b>	247
<b>C6</b> If ABCD isosceles trapezium, then HKLM is a point	353-360, 362, 492	<b>P6</b>	360
<b>C7</b> If ABCD is cyclic, then HKLM is a point	499, 502-503, 507, 511, 519, 538	<b>P7</b>	No proof
<b>C8</b> HKLM is similar to ABCD	76, 96, 101, 109, 241, 247, 462, 528, 542	<b>P8</b>	250-348 (proof attempted but not finished)
<b>C9</b> If the sum of the opposite angles is 180, then the perpendicular bisectors meet at a point; if on the contrary the sum is not 180, a similar quadrilateral appears	491, 527	<b>P9</b>	No proof

Table 6.1. B&amp;T. Conjectures and proofs

The table included above allows some general considerations as far as the proving process of B&T is concerned. These students produce many conjectures, from particular cases to the most general one (C9), which however they do not prove. They do manage to prove other conjectures about particular cases. The fact that for some configurations a point inside is formed struck the students (it happened with almost all students in this study, as we will see in chapter 8). Bartolomeo is aware of the fact that the conjectures need to be proven, and mentions this fact many times in the process. Probably this is due to the didactical contract (Brousseau, 1988) which has been established in the classroom: conjectures need to be proven in order to be validated. So, for Bartolomeo the need for a proof does not seem to come from the need of explaining why something happens, but just because it needs to be done 'to please the teacher'.

<sup>5</sup> The numbers refer to the lines in the transcript (see appendix C, p.268). For each conjecture and proof, I identified the lines in which the students either make a statement which is related to the final conjecture or work towards proving that conjecture.

<sup>6</sup> The formulation of the conjectures is not necessarily the one made by the students.

Table 6.2 below shows the proving process and how conjectures and proofs developed and intersected over time.

Ep.	C1	C2	C3	C4	C5	C6	C7	C8	C9	#	
Ep2	○									65-66	
	○									68	
Ep3		○								70-72	
								○		76	
			○							79	
			○							81-91	
		○								95	
								○		96	
				○						97-100	
Ep4								○		101	
								○		109	
	○									114-117	
	○	○	○	○						123	
			○	○						124	
	●									125- 190	
	●									192-197	
			●							216-226	
	Ep5				○						211
	Ep6		○								214-215
Ep7					○					231-233	
								○		241	
					●			○		247	
Ep8						○				353-360	
						●				360	
						○				362	
				○						431	
				○						440-446	
				●						450-458	
								○		462	
Ep9									○	491	
						○				492	
							○			499	
							○			502-503	
							○			507	
							○			511	
							○			519	
									○	527	
Ep10								○		528	
							○			538	
								○		542	

Table 6.2. B&T. Evolution of conjectures and proofs

○<sup>7</sup> = conjecture, ● = proof

<sup>7</sup>The symbols ○ and ● indicate either the moment in which the conjecture or proof was made or the moments in which students worked towards that conjecture or proof.

## 6.4 TELLING THE STORY OF BARTOLOMEO AND TIZIANA AND THEIR PROVING PROCESS

This section presents the analysis of the proving process of Bartolomeo and Tiziana as concerns the broad categories of the preliminary analytical framework outlined in chapter 5 (see section 5.8). The preliminary categories are:

- The use of dragging
- The use of construction elements
- The use of paper sketches
- Types of statements
- Interactions between students and Cabri
- Interactions between students
- Interplay between the spatio-graphical field and the theoretical field

Key elements for the development of the proving process emerged from the transcript within these broad categories. Key extracts from the transcript are included with the purpose of both illustrating the analysis and showing where the analytic categories developed in chapter 7 are rooted.

### 6.4.1 The use of dragging

The preliminary analytical framework includes the dragging modalities<sup>8</sup> which were identified in a previous study. They are summarised in Table 6.3. These modalities account for what can be seen on the screen by an observer who is looking at what the students do with Cabri.

Non dragging
Dragging test
Wandering dragging
Bound dragging
Guided dragging
Lieu muet dragging
Line dragging
Linked dragging

Table 6.3. Dragging modalities

<sup>8</sup> For a description of the dragging modalities see Table 5.8, p.98.



Figure 6.17 below presents an overview of which dragging modalities the students used in the proving process. We can see that these students used a lot of guided dragging and very little wandering dragging. Only one instance of lieu muet dragging was observed. No dragging was done while proving, but the static Cabri figure on the screen was used as a paper figure and elements were added and deleted over the course of the construction of the proof, but without carrying out any dragging.

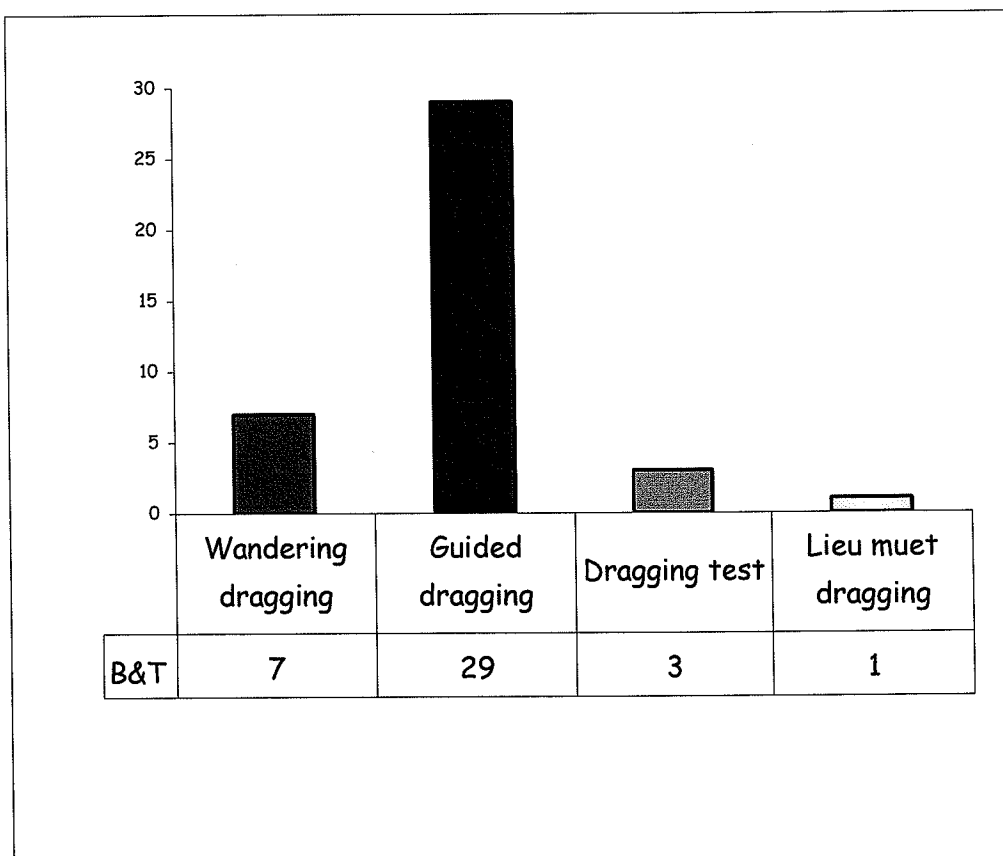

Figure 6.17. B&T. Dragging modalities used throughout the proving process<sup>9</sup>

Figure 6.18 below singles out what modalities each student used and how dragging was shared between the two students. The main thing to be seen is that in general Bartolomeo did more dragging than Tiziana. Tiziana did considerably more wandering dragging than Bartolomeo and Bartolomeo did more guided dragging than Tiziana. And in particular, the transcript shows that Tiziana did guided dragging mainly when Bartolomeo asked her to do so. It seems that the two students are characterised by two different ways of using dragging and each one prefers one particular dragging modality.

<sup>9</sup> The two diagrams in Figure 6.17 and Figure 6.18 show the number of times each dragging modality has been used. The number of times is the number of instances (which correspond to numbered lines in the transcript) in which a particular dragging modality was used, without taking into account the time length of the dragging in that particular instance.

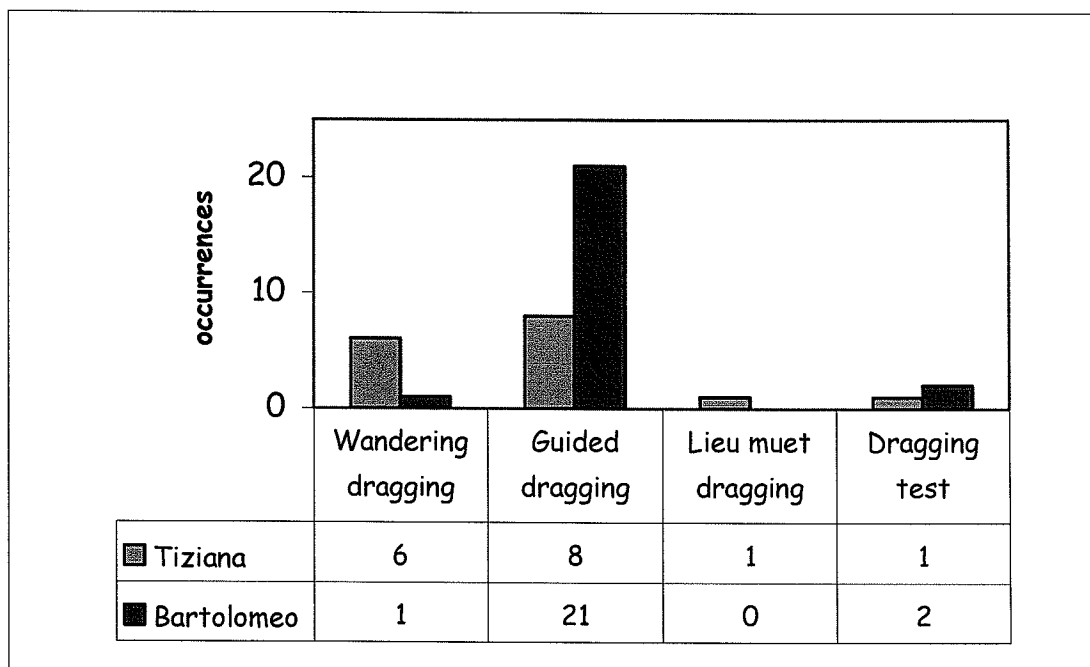

Figure 6.18. B&T. Dragging modalities used by each student throughout the process

The transcript shows that each dragging modality can be associated to a particular strategy of tackling the proving process. The use of *guided dragging* shows a particular exploration strategy that Bartolomeo pursues throughout the proving process, i.e. ordered exploration of particular cases (“let’s see what happens in every case, shall we?” – 60<sup>10</sup>). Especially at the beginning of the process, the students formulate conjectures just after the quadrilateral ABCD has been transformed into a particular quadrilateral via guided dragging (see Extract 6.1).

- 97 Bartolomeo: **try to make it a trapezium**  
 98 Tiziana: **yes**  
 99 Tiziana takes the mouse and **drags C** on the right (Figure 6.19)  
 100 Bartolomeo: **... it becomes a trapezium too**

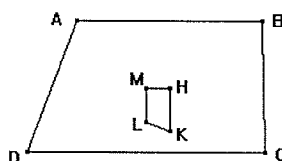

Figure 6.19. B&T, Ep.3, #99

Extract 6.1. B&T, Ep.3, #97-100<sup>11</sup>

<sup>10</sup> The numbers used in the analysis refer to lines in the Extracts.

<sup>11</sup> The captions for the Extracts from the transcripts presented here and in the following chapters contain the initials of the case study they belong to (e.g. B&T), the episode they are taken from (e.g. Ep.3) and the numbers of the lines they correspond to (e.g. #97-100).

---

There is only one incidence of *lieu muet dragging* (80), which shows a different strategy and is very relevant, as far as the formulation of a general conjecture is concerned (Extract 6.2).

- 80 Tiziana: no, because **now it's a point too (Tiziana dragged B so that ABCD is not a rectangle but HKLM is still a point)**.
- 81 Bartolomeo: eh ... well..., but if it is a rectangle it is a point ... it's not the only case ...
- 82 Tiziana drags B fast, but she slows down when she is nearby the positions which make HKLM a point

Extract 6.2. B&T, Ep.3, #80-82

After Bartolomeo formulates the conjecture about the case when ABCD is a rectangle (see Extract 6.3), Tiziana sees that there are other quadrilaterals for which HKLM is a point too (80), by doing *lieu muet dragging*, i.e. by moving B such that a point is kept inside. Her observation is crucial because the general conjecture, which they develop later, is that HKLM is a point if ABCD is a cyclic quadrilateral, i.e. the case of the rectangle is not the only one. However, Bartolomeo is not interested in this discovery (even if he seems to acknowledge the fact) and he writes down his original conjecture, so that Tiziana's observation gets lost for the moment. This observation has a follow up later on in Episode 8, when Tiziana seems to have a conjecture in mind, concerning the quadrilaterals for which there is a point inside. The *lieu muet dragging* of 80 allows her to obtain a figure that is a quadrilateral for which HKLM is a point but is not any particular quadrilateral.

Besides using different dragging modalities, Bartolomeo and Tiziana also show different ways of focusing their attention while dragging. This appears very clearly in Extract 6.3, where the students show two different ways of looking at what happens while dragging.

- 69 Meanwhile Tiziana drags ABCD into a rectangle (Figure 6.20)
- 70 Bartolomeo: what have you done, a **rectangle**?
- 71 Tiziana: yes, well...
- 72 Bartolomeo: **so... it is a point... try to make it bigger...**
- 73 Tiziana: eh, how can I do that?
- 74 Bartolomeo: just dragging!
- 75 Tiziana drags D up and stops to observe and think (Figure 6.21)
- 76 Tiziana: **excuse me! This (she points at LM) follows what this (AB) does, this (LK) follows this (AD) ... (she laughs)**
- 77 Bartolomeo: let's examine some more cases
- 78 Tiziana drags A up and gets Figure 6.22
- 79 Bartolomeo: **ah, when it's a rectangle it's always a point...** (he writes down the second conjecture) ... if... shall I write "disappears" or "is a point"? It's a point...

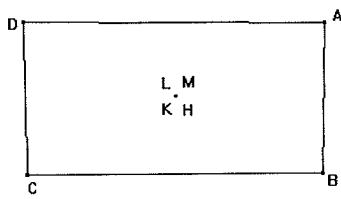

Figure 6.20, B&amp;T, Ep.3, #69

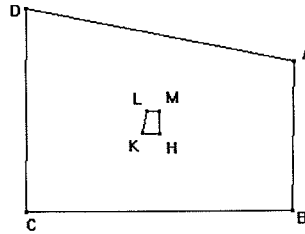

Figure 6.21. B&amp;T, Ep.3, #75

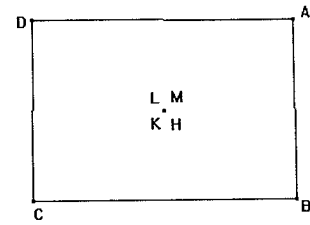

Figure 6.22. B&amp;T, Ep.3, #78



Extract 6.3. B&amp;T, Ep.3, #69-79

This episode is paradigmatic in showing how the same dragging event may be approached in two completely different ways by the students. In 72, 77 and 79 Bartolomeo shows how he wants to use Cabri: to produce and check conjectures in a very systematic way. He pays attention only to the initial and final figure (Figure 6.20 and Figure 6.22), as two snapshots, as his aim was clear: checking if  $HKLM$  is always a point when  $ABCD$  is a rectangle (“always” means in two cases, for him). As soon as Tiziana stops in Figure 6.22 he formulates the conjecture (79). On the contrary, Tiziana is observing the figure over the dragging which takes her from Figure 6.20 to Figure 6.22, through Figure 6.21, ‘reading’ what the figure suggests. She stops in 75 and reads a relationship between elements of the figure (she sees a relationship between the sides of  $ABCD$  and of  $HKLM$ , which again will be transformed into a general conjecture later on in the process). In a sense she is ‘dragged by dragging’: she observes the figure while moving and stops when she sees something interesting. She looks at the film that occurs in front of her eyes and is produced by her.

#### 6.4.2 The use of construction elements

What came out of the transcript of B&T is a particular way of dealing with construction lines, exploiting the possibility of Cabri to hide and show back elements of figures.

Bartolomeo and Tiziana sometimes hide construction lines and sometimes they make them visible again. They hide the construction elements (perpendicular bisectors of  $ABCD$ ) immediately after they finish the construction before starting the exploration via dragging.

55 Bartolomeo: **hide** the lines, the points are connected anyway.

Extract 6.4. B&T, Ep.2, #55

---

So they do the transformation from left to right shown in Figure 6.23 (56). Then the bisectors are made visible every time they say they have to prove something (e.g. the case of the parallelogram in 113, 122, 130 and the case of the trapezium in 233).

- 233 Bartolomeo: here you are ... so another trapezium is formed. Let's **prove** it.  
So let's **put the perpendicular bisectors again**.

Extract 6.5. B&T, Ep.6, #233

The bisectors are hidden after a construction when they want to explore (199, 444, 530).

- 198 Bartolomeo: so we need to look at the rhombus.  
199 Bartolomeo hides the perpendicular bisectors and then drags A, D and B

Extract 6.6. B&T, Ep.5, #198-199

This way of dealing with the construction elements (either hiding or showing them) seems to influence the students' perception of the figures on the screen. When the bisectors are hidden, the attention is focused on the figures as wholes, because this is what appears on the screen. The fact that two separate figures are visible on the screen makes it easy to formulate conjectures about the shapes of the quadrilaterals but does not seem to help with the proof. In fact, they make the bisectors visible again when proving. While proving the case of the parallelogram (P1), these students completely forgot about the fact that the lines they made visible again (the perpendicular bisectors), were actually perpendicular bisectors, i.e. lines perpendicular to the sides of ABCD. They spent time in constructing a proof in which something was always missing, that is a right angle which was there but they could not 'see' until the very end of the proof (Extract 6.7).

- 175 Bartolomeo: so, wait, **if this is a right angle** I can say that...  
176 Tiziana: no, **but it's not** a right angle, what are you talking about? So ...  
177 Bartolomeo: ... it must be, otherwise they are not parallel [...]  
192 Bartolomeo: ... so... let's do this... but look, here there are four right angles, otherwise they are not parallel  
193 Tiziana: oh dear, **look!... the perpendicular bisector**, isn't it? (she points at b) There is always a right angle!

Extract 6.7. B&T, Ep.4, #175-176 & #192-193

The way B&T used construction lines in the first part of the proving process is summarised in Figure 6.23.

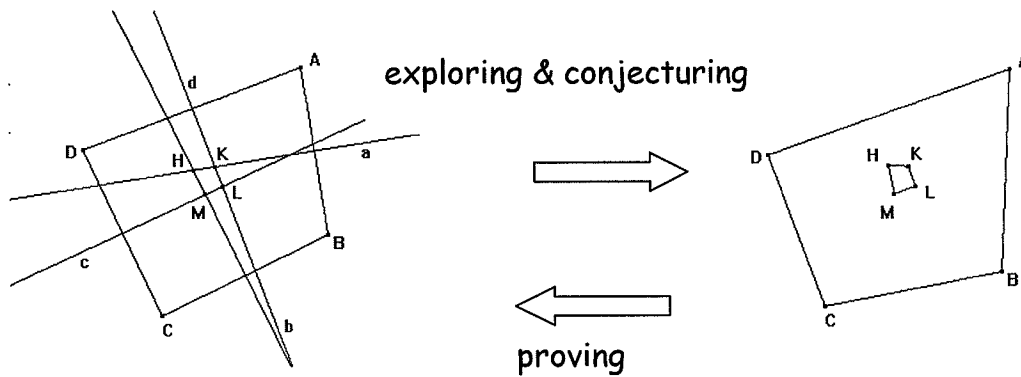

Figure 6.23. B&amp;T. Hiding and showing construction lines.

The situation concerning the use of construction lines changes in episode 8 and episode 9, when Tiziana tries to explore a new situation, which then leads to the discovery of the general conjecture (C7 – if ABCD is cyclic then HKLM is a point). In this case the bisectors of the quadrilateral are left visible and the internal quadrilateral is not marked at all. The aim of this part of the exploration is to find the properties for the configuration in which the bisectors all meet at a point. This process looks more like a search for an explanation of the fact that there are cases in which inside there is a point. And it seems that in this case it is important that the perpendicular bisectors are left visible, as they are to be part of the explanation.

### 6.4.3 The use of paper sketches

The students were given the possibility of using paper and pencil besides Cabri. In this transcript, we can observe the use of paper to do sketches in two instances of the proving process and in two different ways.

- 88 Bartolomeo drags B to get a square.  
 89 Bartolomeo: ... square ... yes, because if ... it happens ... well, if also the rectangle  
 90 Tiziana: I mean, but ... if it is a rectangle it is a point.  
 91 Tiziana **draws a rectangle on paper** with the perpendicular bisectors intersecting in a point (Figure 6.24).  
 92 Tiziana: ... of course it's point!  
 93 Bartolomeo: sure! But this is the proof ... wait...

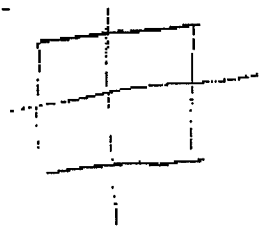

Figure 6.24. B&amp;T, Ep.3, #91

Extract 6.8. B&amp;T, Ep.3, #91-93

The first sketch is done after the formulation of the conjecture about the rectangle (C2 – if ABCD rectangle then HKLM point), as shown in Extract 6.8. After Bartolomeo formulates the conjecture and writes it down, Tiziana has the mouse and sees by dragging that there are other cases in which there is a point inside (see Extract 6.2, p.120). Bartolomeo seems not to be interested in that observation, so he takes the mouse and does something else, before eventually writing down the conjecture about the rectangle. At this point, Tiziana draws a sketch on paper of a rectangle (91) and says: "of course it is a point!" (92). It seems that sketching that figure on paper has allowed her to understand why if ABCD is a rectangle then there is a point inside. Bartolomeo sees the proof on the sketch (93).

- 434 Bartolomeo draws the perpendicular bisectors of the side of the rhombus  
 435 Bartolomeo: why is it so big?  
 436 Bartolomeo marks the intersection points to get HKLM (Figure 6.25)  
 437 Bartolomeo: is it marked??  
 438 Bartolomeo goes left to see the bit of the drawing which is outside the visible part of the screen  
 439 Tiziana: yes, but **what's that?**  
 440 Bartolomeo: well, it's a bit big!... so... a rhombus is formed ... then...  
 441 Meanwhile Tiziana **draws a rhombus on paper** with the perpendicular bisectors meeting in the intersection point of the diagonals (Figure 6.26).

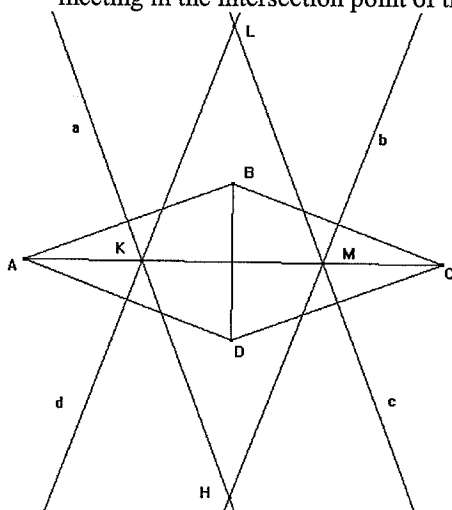

Figure 6.25. B&T, Ep.8, #436

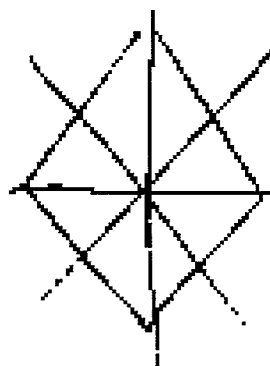

Figure 6.26. B&T, Ep.8, #441

Extract 6.9. B&T, Ep.8, #434-441

The second sketch seems to have a different function (Extract 6.9). Bartolomeo draws a rhombus on the screen, then the perpendicular bisectors and the points of intersection. Tiziana seems not to understand what that figure is, because it is very big and nearly goes out of the screen (Figure 6.25). In 441, Tiziana draws a rhombus on paper (Figure 6.26). In this case, it seems that the need for going to paper is due to the fact that Tiziana does not understand the figure on the screen; she cannot 'read' it and therefore needs to reconstruct it herself in a maybe more familiar way and environment (paper). In this case the sketch seems to serve more as a tool for thinking.

#### 6.4.4 Types of statements

An important category suggested by theoretical considerations about the proving process is the use of different types of statements in the process of constructing and formulating conjectures and proofs. Table 6.4 presents the evolution of the statements related to the formulation of some conjectures over the course of the process. Different types of formulations can be identified and the evolution from one type of statement to another, related to the same configuration, seems to be crucial for the production of conjectures and eventually proofs. What is most striking is the difference between statements which contain a 'dynamic' element and statements which are static. The particular types of statements observed will be specified and classified in the analytical framework.

	Conjectures	Type of statements
<b>C2</b>	<b>If ABCD rectangle, then HKLM point</b>	
	Bartolomeo: What have you done, a rectangle? (70) ...so...it's a point (72).	This is a description of a particular case.
	Bartolomeo: When it's a rectangle it's always a point (79).	After dragging to another rectangle configuration, the conjecture is expressed in a dynamic form: <i>always</i> constructs generality in time.
	Bartolomeo: If ABCD is a rectangle then HKLM is a point (81).	Now the conjecture is static: generality has been constructed so time is no longer present and the conjecture is written in the standard way.
	Bartolomeo: If it is a rectangle... also a square (123)	A new fact is observed while the figure is dragged to a square configuration, but the complete conjecture is not formulated here.
	Bartolomeo: In the case when this quadrilateral becomes a rectangle or a square we have that (214) Tiziana: ... KLMH changes ... it's a point (215)	The description is transformed into a dynamic conjecture first, which describes an action of transforming ABCD, and then it becomes static: it's a point.
<b>C3</b>	<b>If ABCD trapezium, then HKLM trapezium</b>	
	Bartolomeo: Try to make it a trapezium (97) ...it becomes a trapezium too (100).	This conjecture is formulated while the action of dragging is carried out and the formulation embodies the action itself.
	Bartolomeo: .. if this is a trapezium ... also that one is a trapezium (123)	Here the conjecture is static and it expresses a relationship that always holds.
	Bartolomeo: If ABCD is a trapezium, then HKLM is a trapezium (124)	The static relationship is written down.

Table 6.4. B&amp;T. Types of statements



---

#### 6.4.5 Interactions between students and Cabri

The discussion around dragging in section 6.4.1 has already shown a difference in the ways the two students used dragging. More generally, Bartolomeo and Tiziana show two different kinds of interaction with Cabri throughout the course of the proving process. They use the software in two different ways which reveal two different aims, even though they were probably not explicit to the students.

Bartolomeo shows a control over the software, in that he uses Cabri to accomplish a plan, that is to explore different cases for ABCD and discover what happens to HKLM. The student seems to be in control of the situation and exploits the software for his own ends. When he does not have the mouse he tells Tiziana what to do. Extract 6.1 (p. 119) shows a typical example of Bartolomeo's interaction with Cabri.

On the contrary, Tiziana seems not to have a strategy at the beginning. She uses Cabri in order to get ideas and to explore the situation. She is open to 'read' what happens in Cabri, without interpreting it in a pre-planned strategy. An example of her typical behaviour is in Extract 6.2 (p.120). After discovering that when ABCD is a rectangle then HKLM is a point, by experimenting with dragging and 'reading' what is on the screen, Tiziana finds other cases for which HKLM is a point (80-82). She is absorbed by the Cabri environment and needs to do things in order to get ideas and think. In fact, this behaviour is observed throughout the process. For example, when Bartolomeo does not let Tiziana have the mouse back, she draws on paper (see Extract 6.8, p.123), as if she needed a physical experience anyway, and since she cannot get the mouse she finds herself another space. Extract 6.3 (p.121) is another example of Tiziana's typical interaction with Cabri, reading what is happening in Cabri while she is dragging (76). She follows carefully the figure while she is dragging and stops whenever she sees something interesting.

#### 6.4.6 Interactions between students

The B&T transcript shows different ways in which the students interact with each other and try to communicate throughout the proving process. Each student tells his/her own story, but at the same time the two stories need to intersect, given that only one computer is available to them. What can be noticed is that there are moments in the process in which the students think and do different things and moments in which a good communication takes place and the students really work on the 'same' problem. An interesting thing is to observe how students get to communicate and 'merge' their stories towards a common goal, which is the production of conjectures and proofs.

The following extract (Extract 6.10) shows a situation in which the two students are thinking about and doing different things. Bartolomeo, who does not have the mouse and therefore cannot do what he wants, suggests an idea, but Tiziana, who has the mouse, chooses to do something else. However, at the end they succeed in communicating within the shared Cabri space.

**Bartolomeo<sup>12</sup>**

49 Bartolomeo: did you do it for L and M? Now go to pointer and let's try to move...

51 Bartolomeo: try to move...

53 Bartolomeo: so, let's do this...

55 Bartolomeo: hide the lines, the points are connected anyway

57 Bartolomeo: ok, try to make it a trapezium...

60 Bartolomeo: let's see what happens in every case, shall we?

**Tiziana**

50 Tiziana: no, wait, shall we delete...? No

52 Tiziana drags D randomly rightwards and then leftwards

54 Tiziana: eh, excuse me, isn't that a...

56 Tiziana hides the perpendicular bisectors (Figure 6.27)

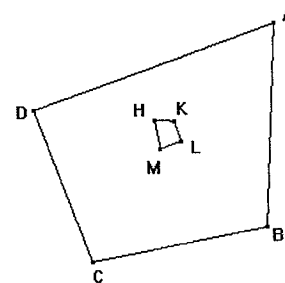

Figure 6.27. B&T, Ep.2, #56

58 Tiziana drags D

59 Tiziana: is it a trapezium?

61 Tiziana: wait, eh... let's do this...

<sup>12</sup> This extract is presented in a form that shows the interaction between the students. The arrows keep track of the ideas being developed by the two students.

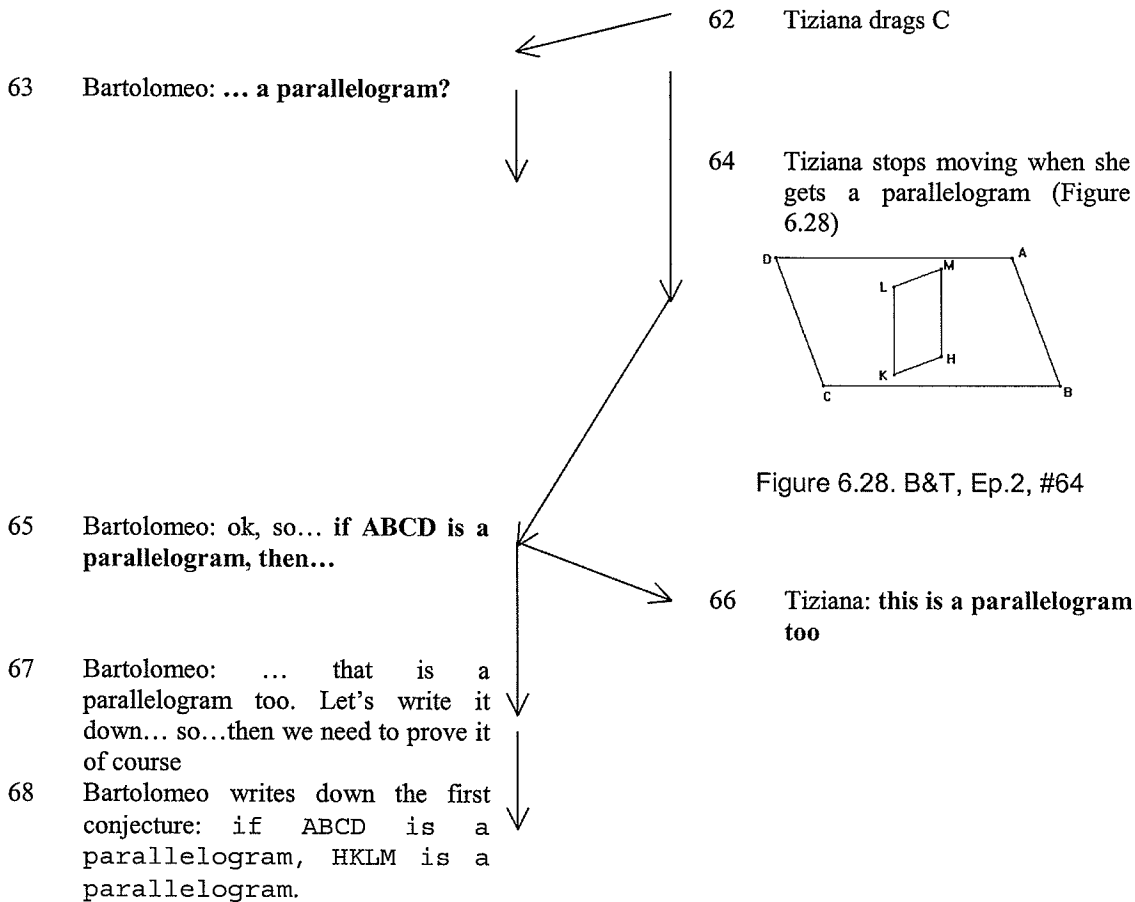

Extract 6.10. B&T, Ep.2, #49-68

Bartolomeo has a strategy in mind and wants to move ABCD (49). Tiziana wants to make the figure 'perfect' before moving (50). Tiziana starts moving in 52, accomplishing Bartolomeo's wish. Bartolomeo continues to think about his own strategy which he has not made explicit yet (53). Tiziana is thinking about something on her own. She is looking at the Cabri figure and 'reading' it (54). Bartolomeo makes explicit what he wants to do (57). Tiziana follows what Bartolomeo says but without seeming to understand where he wants to go (58). Bartolomeo makes explicit the general strategy he has in mind, that is an ordered exploration of cases (60): what happens to HKLM when ABCD is a...? This time Tiziana does not pay attention to what Bartolomeo says and pursues her own idea ("wait" - 61), without talking Bartolomeo through it. They are going along two different paths; they have different strategies. They both have ideas so it is the person who has the mouse that leads the situation. Tiziana has the mouse and she does what she wants (62), forcing Bartolomeo to follow her in her thoughts. Bartolomeo is surprised to see a parallelogram (63) on the screen because he does not know what Tiziana wants to achieve. It is only when dragging is stopped (64) that the two students produce a conjecture about the same thing. At this point (65-66) the students seem to be sharing the 'same' story, after a whole episode in which

they were not communicating (49-64). The communication seems to take place around Figure 6.28 and it seems to be more a fact of 'tuning' each other's thoughts than only communicating with each other. It is a visual element, not a spoken one that provides mutual understanding. There is no need for speaking at this point, everything happens around a Cabri figure which now has a shared meaning. A conjecture can be produced by both students at the same time (65-66).

#### **6.4.7 Interplay between the spatio-graphical field (SG) and the theoretical field (T)**

In section 6.4.2, it was observed that the students act on the spatio-graphical field by changing the aspect of the figure they have to work with, according to the aim they pursue (exploring-conjecturing or proving). The interplay between the spatio-graphical field (i.e. the Cabri and paper figures) and the theoretical field (i.e. geometrical definitions and properties) seems to be very important in the proving process. Bartolomeo and Tiziana show different ways of dealing with this interplay: at some stages they work at a spatio-graphical level only, some other times they show moves up and down from the spatio-graphical field to the theoretical field and back.

For example, during the construction (1-48) the students work at a spatio-graphical level. The work is within Cabri and all elements correspond to a Cabri function only, with no geometrical meaning. The students do not mention the geometrical property of the perpendicular bisectors when constructing the quadrilateral at the beginning. And they do not mention it at all until line 193 in the proof for the conjecture about the parallelogram (C1- if ABCD parallelogram then HKLM parallelogram), when they finally 'see' four right angles and connect them to the perpendicular bisector's property of being perpendicular to the side (195-196). Each time they say they have proven the conjecture, a bit of the justification is always missing in what they say, which is exactly the fact that there are right angles. They probably see the property implicitly on the screen (178-180, 194) but are not able to distil it and make it explicit. In the whole episode there seems to be a conflict between seeing things on the figure and trying to find a theoretical explanation for that (138). In line 149 Bartolomeo makes it explicit that they know the conjecture is true, because they see it is true in the figure on the screen, but they have to prove it<sup>13</sup>. Line 166 is a justification within the Cabri field of why the figure on the screen is a parallelogram, without thinking that that was a hypothesis. Until line 180, the visual component is too

strong and does not let them focus on the geometrical properties. There is a need to change the way they look at the figures on the screen: they should no longer be considered as a field of discovery, from which properties are 'read', but a support for theoretical properties, as happens in 195.

- 138 Bartolomeo: **it marks them equal, so it means that** since they are ... alternate internal equal ... KL and HM are... parallel... however we should prove that they are alternate internal equal, because it's not enough ... (Figure 6.29) [...]
- 149 Bartolomeo: what shall we do?... so, **we know it's true, but we need to prove it** ... well, we can prove that HLM, this triangle, equals that one (he points at the triangle KLH with the mouse), so if they will be equal, the angles in L and in H will be equal too; so these are parallel (points at KL and HM), is that right? [...]
- 165 Bartolomeo: well, this one outside (points at ABCD) is a parallelogram
- 166 Tiziana: **because you constructed it** [...]
- 178 Bartolomeo: so, wait, **if this is a right angle** I can say that...
- 179 Tiziana: no, **but it's not a right angle**, what are you talking about? So ...
- 180 Bartolomeo: ... it must be, otherwise they are not parallel [...]
- 194 Bartolomeo: ... so... let's do this... but look, here there are four right angles, otherwise they are not parallel
- 195 Tiziana: oh dear, **look!... the perpendicular bisector**, isn't it? (she points at b) There is always a right angle!
- 196 Bartolomeo: I see! How stupid we are! So, therefore, this is right angle, and this one too...and these are right angles. Therefore if it is right angle, they are parallel
- 197 Tiziana: so this equals this...
- 198 Bartolomeo: they are parallel, ok, fine till now
- 199 Tiziana: and these are parallel too (points at a and c), therefore this is a parallelogram (points at HKLM)

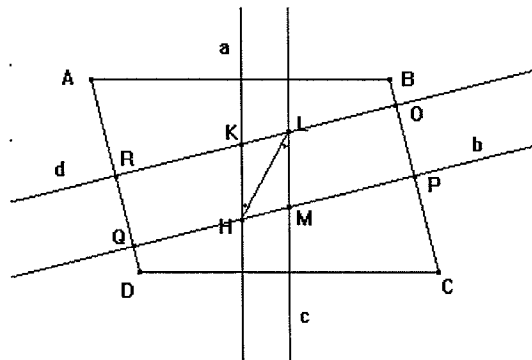

Figure 6.29. B&T, Ep.4, #135

Extract 6.11. B&T, Ep.4, #138-199

At the beginning of the process, Tiziana seems to pay much attention to the appearance of the figure and she does not want to move before having a 'perfect' figure. She seems to be very linked to the spatio-graphical field and she needs to start from there in order to understand the situation and formulate conjectures. In general, both students formulate all

<sup>13</sup> This links up with what Polya wrote (1954): understanding and conviction are necessary conditions for proving; when you have satisfied yourself that the theorem is true, you start proving it.

conjectures (C1 to C6) by looking only at one or two figures. For example, they do not move ABCD any more before being sure that the fact that if ABCD is a parallelogram then HKLM is a parallelogram (C1) is a general fact (see Extract 6.10, p.128). The spatio-graphical field works as a field of discovery from which properties about figures are 'read'.

## 6.5 KEY ELEMENTS IN THE PROVING PROCESS OF BARTOLOMEO AND TIZIANA

This section singles out the main points from the analysis of the story of Bartolomeo and Tiziana. This will set the ground for the development of the analytical framework (chapter 7).

In the course of the proving process, Bartolomeo and Tiziana formulated many conjectures and some proofs. In particular, they constructed a very general conjecture which incorporates all particular cases (C9 - if the sum of the opposite angles of ABCD is 180, then the perpendicular bisectors meet at a point; if the sum is not 180, HKLM is similar to ABCD). Cabri was fundamental in the discovery of this last conjecture, because it was the whole proving process (from the beginning to end of the session) in Cabri which laid the path towards this general conjecture. A question to focus on then is: what are the key elements which characterise the story of Bartolomeo and Tiziana and account for important moves in the proving process?

Starting with **the use of dragging**, it was shown that generally these students use a lot of guided dragging, while there is only one instance of lieu muet dragging. The two students seem each to prefer a particular dragging modality: Bartolomeo uses mainly *guided dragging*, while Tiziana does more *wandering dragging*. The use of a particular dragging modality corresponds to a solution strategy: for example Bartolomeo's strategy is that of exploring ordered cases and he carries it out by doing guided dragging. The episode of *lieu muet dragging* is revealed to be important within the production of the general conjecture (C9). This suggests that dragging modalities are important variables in the development of the proving process. Besides the dragging modalities, it was observed that also what the students focus on while dragging is important and is a sign of different strategies. Bartolomeo shows attention only to the initial and final states of dragging, while Tiziana pays attention to what happens during the whole dragging episode. Since these two modalities lead to different discoveries, the choice of one or the other (even if unconscious) may be an important element of the proving process.

---

As far as **the use of construction elements**, Bartolomeo and Tiziana make use of the possibility of hiding and showing elements without deleting them. They hide and show construction lines with different purposes: hiding construction lines when exploring and making them visible again when proving. If the construction elements are hidden then the exploration seems to take place at a more visual level, because what is seen on the screen is just two quadrilaterals that are related via dragging, in the sense that if ABCD changes then HKLM changes too. However the theoretical-geometrical elements that explain why such a relation holds are hidden and not available to students on the screen. The construction elements need to be shown again by the students, as happens for B&T when they decide to prove the case of the parallelogram. The situation however changes in the final part of the transcript when construction lines are left visible. All this suggests that hiding or showing construction lines may reveal a key step in the proving process, with the different things it affords.

Concerning **the use of sketches**, Tiziana goes to paper and does some sketching, twice over the course of the process, for two different reasons. The first time it is because she cannot have the mouse but is thinking about the situation they are analysing (C2). And at that point Bartolomeo sees the proof on the sketch. The second time it is because she seems not to be able to understand the Cabri figure which is on the screen, so she prefers drawing something more manageable and which she can control. All this happens while exploring and conjecturing. Sketches then seem to have a role in the proving process.

Regarding **the types of statements**, it was clearly shown that the same conjectures are reformulated more times and in different ways in the course of the proving process. What feels important is to be able to describe the different types of statement in terms of them being pure descriptions of what is on the screen or stating relationships between elements or figures and on the fact that they are static or dynamic. The use of theory in the formulation of conjectures and construction of proofs has to be taken into account as well, and especially the way theoretical statements are included in the proving process together with statements more related to the story developing in Cabri.

The overall use of dragging and construction elements from Bartolomeo and Tiziana has shown that each student has a particular **way of interacting with the software**. Bartolomeo seems to exploit Cabri to accomplish his own plan or strategy while Tiziana seems very much open to 'read' what the software has to offer her, even if of course it is her 'creating' the story she is 'reading' on the screen. Taking into account these modalities of interaction

may provide a control over the way and the extent to which the software has an impact in the proving process, as compared to paper and pencil environments.

As far as the **interaction between the students**, this case shows that moments of non-communication and different focus are alternated with moments of communication and shared focus; this ‘communicating’ seems to happen within and through the Cabri environment. In this way, Cabri seems to have the function of support in the construction of a joint problem space (Teasley & Roschelle, 1993) in which the two students can interact towards the production of conjectures and proofs. Defining these two different moments of interaction may be relevant to understand the development of the proving process as a joint activity.

Bartolomeo and Tiziana manage the **interplay between the spatio-graphical field and the theoretical field** at different levels: sometimes they work purely at a spatio-graphical level and some other times they bring about theoretical elements too. What turns out to be most interesting are the moves up and down from the spatio-graphical field to the theoretical field and back and the ways students try to connect the two fields towards the construction of a proof.

## 6.6 SUMMARY

This chapter has discussed the story of the proving process of a first case study (B&T-Case1) according to the broad categories of the preliminary analytical framework and has set out the key elements of the proving process as they emerged from the transcript. All preliminary categories were observed and the transcript provided interesting specifications for them, as shown in Figure 6.30.

The next chapter (chapter 7) will draw on this story and show how the analytical framework was developed, framing the key elements of proving processes in dynamic geometry environments.



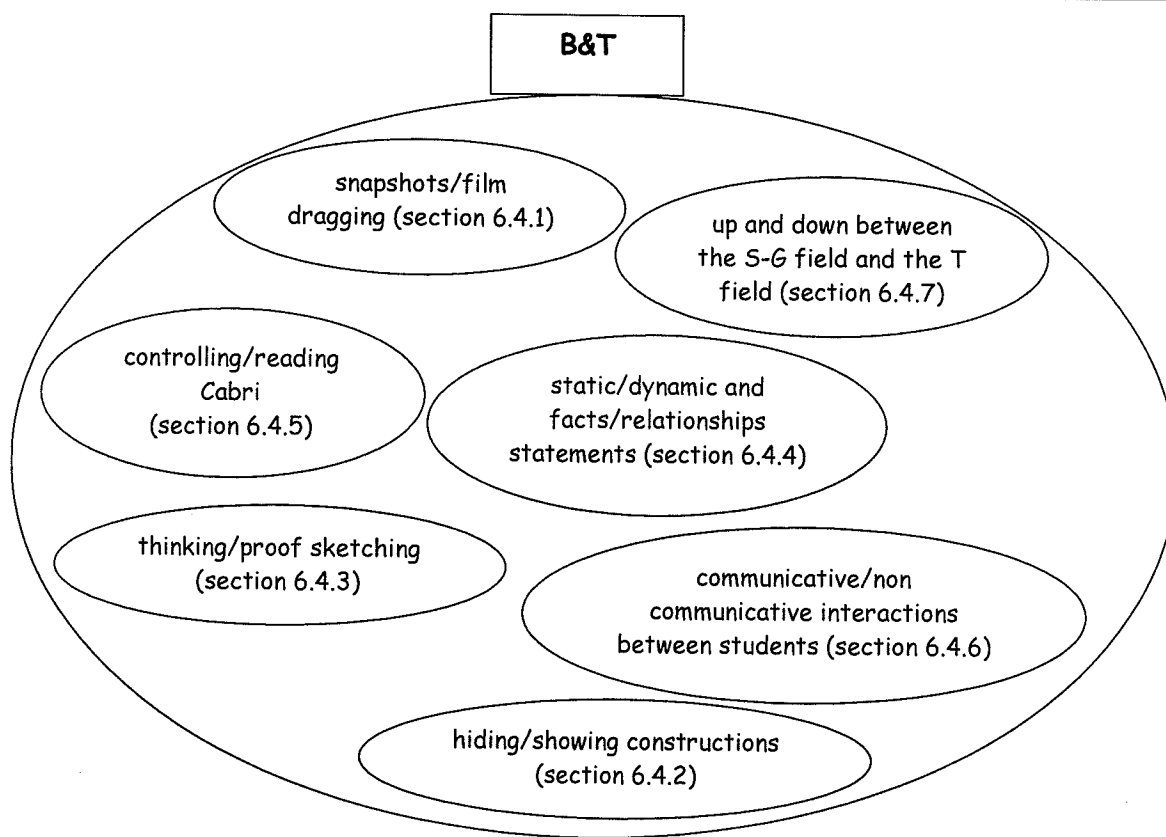

Figure 6.30. B&T. Key elements of the proving process

## **CHAPTER 7. DEVELOPING AN ANALYTICAL FRAMEWORK**

*We are engaged in the generation of theory not primarily as a predictor of variables, but as a pattern which we will recognise when it recurs. If the theoretical pattern is sufficiently recognisable, useful and sensitively constructed, and if our segment of the world is not too unrepresentative of aspects of that pattern, it may turn out to be recognisable, appealing and useful to others as well.*

*(Gherardi & Turner, 2002, p.93)*

### **7.1 INTRODUCTION**

This chapter is concerned with "constructing a map" (Miles & Huberman, 1994, p.91). It will elicit from the story of Bartolomeo and Tiziana (chapter 6) the key categories to be analysed in order to describe the proving process within Cabri. It will be shown how themes and trends that emerged from the story were transformed into an analytical framework, which is a first result of the analysis.

The chapter is divided into four sections. First, an analytical framework is developed. Then each category is described in detail, according to the place it has in the analytical framework.

### **7.2 DEVELOPING AN ANALYTICAL FRAMEWORK**

In chapter 5, a preliminary analytical framework was presented (see section 5.8), in which broad categories of analysis were derived from different sources (literature, exploratory study, and analysis of new transcripts). The story of Bartolomeo and Tiziana (chapter 6) brought to light key elements in the proving process and showed how all categories can be specified in different ways. This section will show how the final analytical framework

---

emerged from both the analysis of data and previous inputs (as described in chapter 5, p.97). The analytical framework is a frame which links together key elements of the proving process and is used to look at the other data.

The two main aims of this research concern the development of the proving process in a dynamic geometry environment and the interactions taking place within this process. Students work in pairs at the computer with Cabri solving open problems. The proving process can be observed through what students say (language) and what students do (actions). By talking and acting, towards the aim of constructing conjectures and proofs, students produce objects and statements which evolve throughout the process.

The focus of the analytical framework is then on two kinds of **transformations** that the proving process involves: transformations on objects (which will be referred to as TO) and transformations on statements (which will be referred to as transformations TS). The transformations on objects (TO) involve manipulations of real objects either in the Cabri environment, for example via dragging, or on paper, and of 'mental' objects (see transformational reasoning, Simon, 1996). These objects are transformed from particular objects into generic objects (Balacheff, 1982). The transformations on statements (TS) refer to the shifts from facts and experiences in a precise space and time to de-timed logical statements of the form 'if ...then'. These statements have a different epistemological status, and the shifts are essential in the context of an approach to theoretical thinking.

The categories of analysis previously identified (see section 5.8) were divided according to the different kinds of transformations they account for. This classification is not meant to be exhaustive, but concerns only the elements of the proving process which were chosen to be investigated on the basis of the rationale discussed in chapter 5 (see section 5.8)<sup>1</sup>. Type A categories are the ones accounting for transformations on objects (TO) and they are: the use of dragging, the use of construction elements and the use of paper sketches. Type B categories are the ones related to transformations on statements (TS) and they are: types of statements. Type C categories are the ones which are based on the previous two categories and therefore produce both transformations on objects (TO) and on statements (TS) and they are: the interactions between students and Cabri, the interactions between students and

---

<sup>1</sup> There are other relevant elements which affect the proving process, e.g. the interaction between the students and the teacher, but these were not included because this research focuses more on the learning point of view and the unit of analysis is the student (or pairs of students) with the computer.

the interplay between the spatio-graphical field and the theoretical field. Figure 7.1 represents the analytical framework.

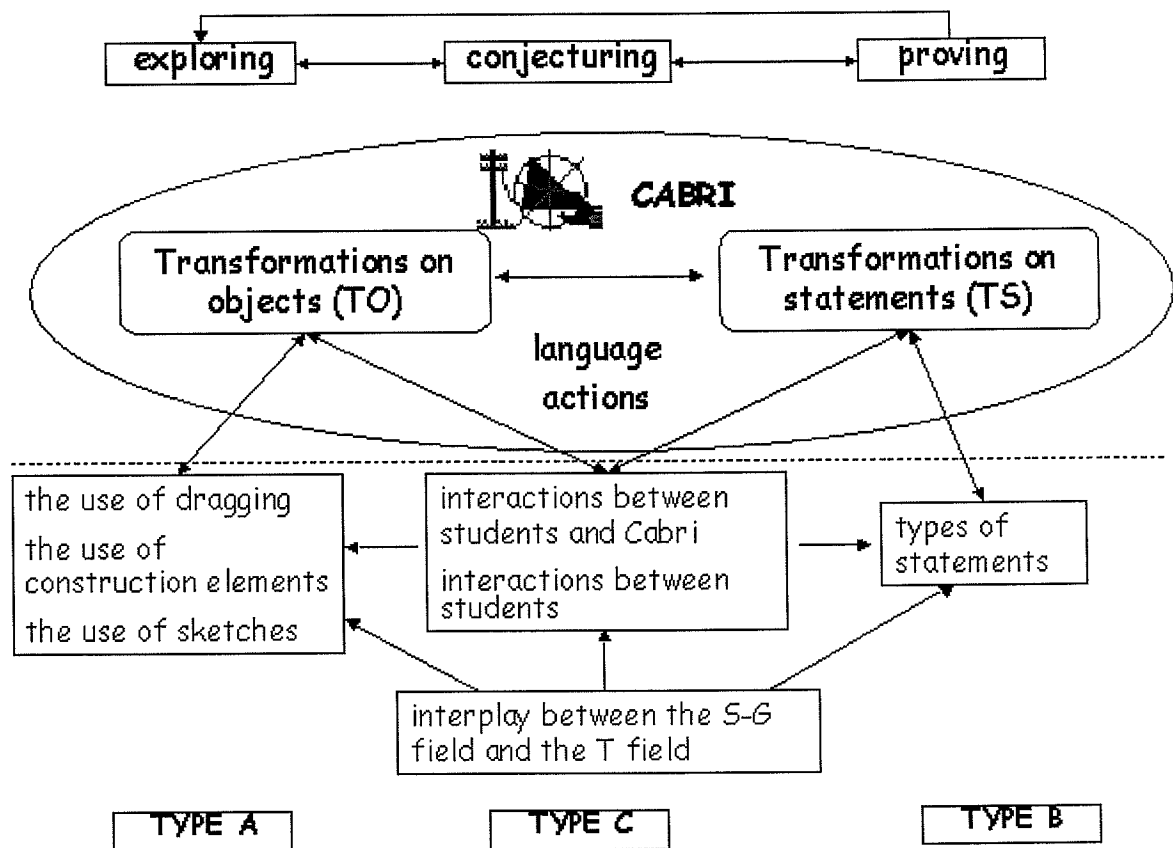

Figure 7.1. The analytical framework

### 7.3 TYPE A CATEGORIES - TRANSFORMATIONS ON OBJECTS

Figure 7.2 represents the categories related to the TO transformations specified into different instances. This section will illustrate all the categories with examples from the transcript analysed in the previous chapter.

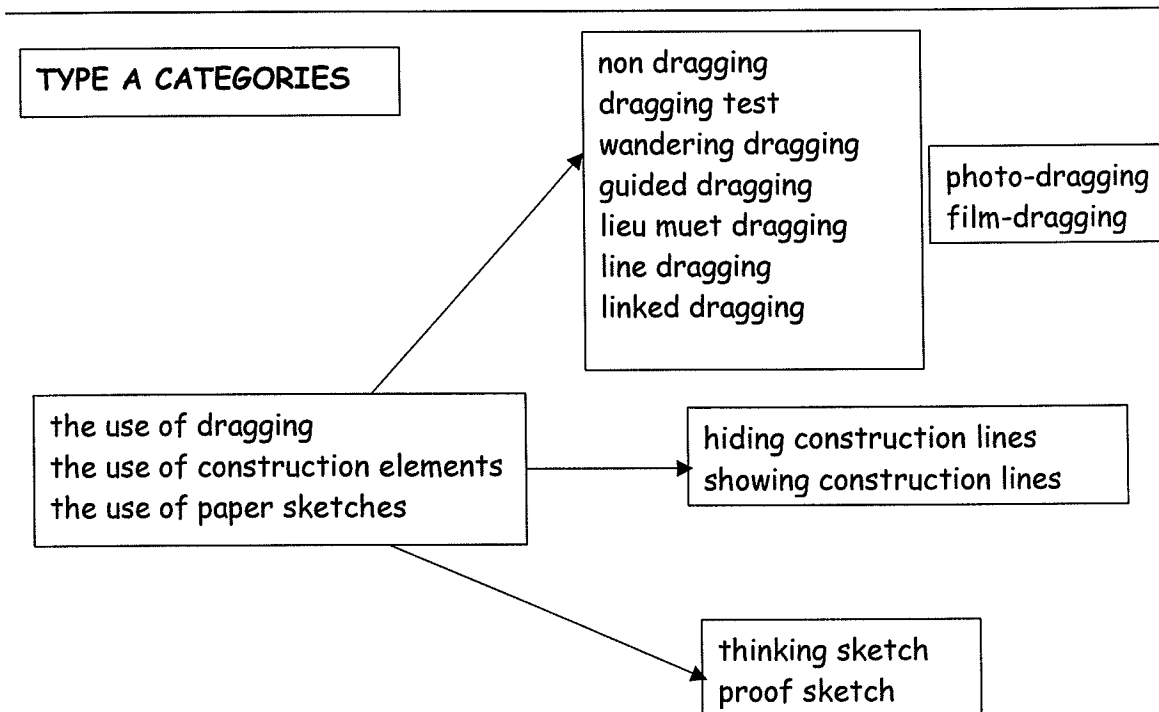

Figure 7.2. Type A categories

### 7.3.1 (DM) Dragging modalities

As came out from the analysis of B&T (see chapter 6), two aspects are to be taken into account in the analysis of the dragging function: what appears at the interface when students are using Cabri, i.e. the dragging modalities (Table 7.1), and where students appear to be focusing their attention while dragging (Table 7.2).

The dragging modalities are taken from the previous study (Olivero, 1998; Olivero, 1999) and are summarised in Table 7.1.

<b>DRAGGING MODALITY</b>	<b>Description</b>	<b>Examples<sup>2</sup></b>
<b>Non dragging</b>	Not moving anything on the screen.	
<b>Dragging test</b>	Moving draggable or semi-draggable <sup>3</sup> points in order to see whether the figure keeps the intended properties.	364 Tiziana takes the mouse and goes to circle. She tries to make a circle with the centre in the intersection of the perpendicular bisectors and going through the vertices of ABCD.

<sup>2</sup> Whenever possible, the examples illustrating the analytical categories are taken from the transcript analysed in chapter 6 and will show how the category emerged from the data or how the data confirmed the occurrence of an a priori category.

<sup>3</sup> Draggable points are the free points, that is the ones which are constructed using the menu 'point'. Semi-draggable points are points on objects, that can move only on that object (e.g. points on a circle).

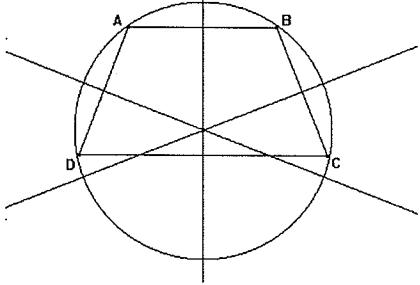
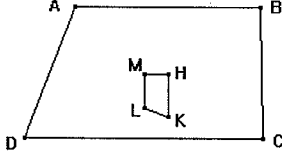
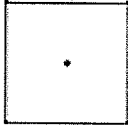
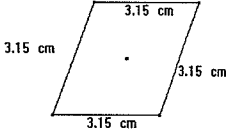
		 <p>Figure 7.3. B&amp;T, Ep.8, #364</p> <p>372 Tiziana drags the circle to enlarge it, thinking that ABCD will enlarge too.</p>
<b>Wandering dragging</b>	Moving the basic points on the screen randomly in order to discover configurations or regularities in the figures.	<p>52 Bartolomeo: try to move ...</p> <p>53 Tiziana drags D randomly rightwards and then leftwards.</p> <p>54 Bartolomeo: so, let's do this ...</p> <p>55 Tiziana: eh, excuse me, isn't that a ...</p>
<b>Guided dragging</b>	Dragging the basic points of a figure in order to give it a particular shape (e.g. to make it a rectangle), or to give another figure a particular shape (e.g. in the Varignon's problem <sup>4</sup> , dragging the external quadrilateral so that the one inside has got equal sides).	<p>97 Bartolomeo: try to make it a trapezium</p> <p>99 Tiziana takes the mouse and drags C on the left (Figure 7.4).</p> <p>100 Bartolomeo: ...it becomes a trapezium too.</p>  <p>Figure 7.4. B&amp;T, Ep.3, #99</p>
<b>Lieu muet dragging</b>	Moving a basic point so that the figure keeps a discovered property (e.g. the fact that the internal quadrilateral is a point in the angle bisectors problem). This means you are following a hidden path (lieu muet), even without being aware of this. Or moving basic points along a given (not visible) path (e.g. following the prolongation of a diagonal).	<p>148 Alice<sup>5</sup> makes a point inside and a square outside (Figure 7.5).</p> <p>173 Alice moves CD (the upper side) up so to keep a point inside (Figure 7.6) then stops.</p>  <p>Figure 7.5. A&amp;W, Ep.5, #148</p>  <p>Figure 7.6. A&amp;W, Ep.6, #173</p>
<b>Line dragging</b>	Drawing new points on the ones that keep the regularity of the figure.	The researcher observing them suggests them to mark a discrete trace, that is to mark the points corresponding to C as 60° (Figure 7.7).

<sup>4</sup> See Appendix B (p.266) for the statement of Varignon's problem.

<sup>5</sup> This example from A&W illustrates better what lieu muet dragging is than the lieu muet dragging B&T do.

		 <p data-bbox="852 454 1241 488">Figure 7.7. Group 12, Session 8<sup>6</sup></p>
<b>Linked dragging</b>	Linking a point to an object and moving it onto that object.	

Table 7.1. Dragging modalities (DM)

Bartolomeo and Tiziana were observed to have different ways of focusing on the figure under dragging. The following quotes by Mason & Heal (1995) corroborate the importance of taking into account where students focus their attention while dragging:

Geometry packages use cursor-movement linked to muscular movement to associate near-ness with a sense of the general (as Cabri). Spatial location and muscular movement in space are linked to variance and invariance, which lies at the heart of awareness of generality. Although only a finite number of positions can actually be sampled, there is a film-like impression of continuity as the mouse drag objects over the screen. (p.298)

and

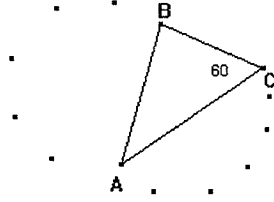
You can think of a sequence of images as a single moving figure, changing its size or other attributes, and you can also think of it as the successive lighting up of a whole family of such figures, so that your attention is attending to different ones over time, or it is varying the attributes of a single object. (p.298)

Along with these observations, another category was developed, as presented in Table 7.2.

<sup>6</sup> This example is taken from the exploratory study (see Olivero, 2001).



<b>DRAGGING</b>	<b>Description</b>	<b>Example</b>
<b>Photo-dragging (discrete dragging)</b>	Modalities which suggest a discrete sequence of images over time: the subject looks at the initial and final state of the figure, without paying attention to the intermediate instances. The aim is to get a particular figure.	70 Bartolomeo: what have you done, a rectangle? (Figure 7.8) 71 Tiziana: yes, well... 72 Bartolomeo: so... it is a point... try to make it bigger... 73 Tiziana: eh, how can I do that? 74 Bartolomeo: just dragging!
<b>Film-dragging (continuous dragging)</b>	Modalities which suggest a film: the subject looks at the variation of the figure while moving and the relationships among the elements of the figure. The aim of dragging is the variation of the figure itself.	75 Tiziana drags D up and stops to observe and think (Figure 7.9) 76 Tiziana: excuse me! This (she points at LM) follows what this (AB) does, this (LK) follows this (AD) ... (she laughs) 77 Bartolomeo: let's examine some more cases 78 Tiziana drags A up and gets Figure 7.10. 79 Bartolomeo: ah, when it's a rectangle it's always a point... (he writes down the second conjecture) ... if... shall I write "disappears" or "is a point"? It's a point...
 <p>Figure 7.8. B&amp;T, Ep.3, #69</p>	 <p>Figure 7.9. B&amp;T, Ep.3, #75</p>	 <p>Figure 7.10. B&amp;T, Ep.3, #78</p>
<b>photo-dragging</b>		
<b>film-dragging</b>		

Table 7.2. Film-dragging and Photo-dragging

### 7.3.2 (C) Hiding and showing construction elements

As far as the use of construction elements, we saw that Bartolomeo and Tiziana hide and make them visible at different moments of the proving process, according to different aims. The possibility of hiding and showing construction elements was considered a relevant category to take into account. In fact, the way students manage this feature of the software is found to be very relevant in the focusing process, in that hiding or showing means

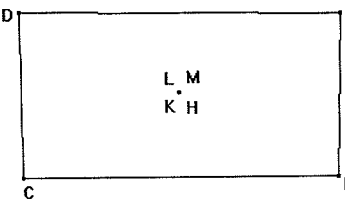
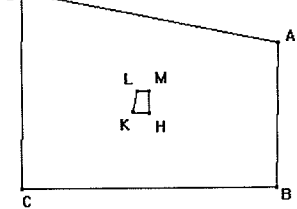
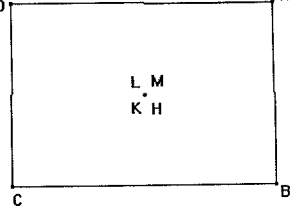
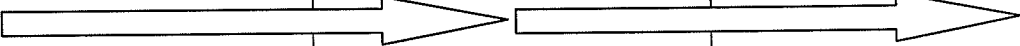

choosing what to focus on and therefore which line of conjecturing and proving to follow.

The category is presented in Table 7.3.

CONSTRUCTIONS	Description	Examples
<p><b>Showing construction elements<sup>7</sup></b></p>	<p>The students leave the construction elements (e.g. perpendicular bisectors in B&amp;T) visible or make them visible.</p>	<p>127 Bartolomeo: so .. we must prove those two are parallel ... we can ..</p> <p>130 Tiziana does this and then <b>makes the perpendicular bisectors visible</b> (Figure 7.11).</p>  <p>Figure 7.11. B&amp;T, Ep.4, #130</p>
<p><b>Hiding construction elements</b></p>	<p>The students hide the construction elements (e.g. perpendicular bisectors in B&amp;T) and leave visible only the figures required by the problem (e.g. two quadrilaterals).</p>	<p>55 Bartolomeo: <b>hide the lines</b>, the points are connected anyway</p> <p>56 Tiziana hides the perpendicular bisectors (Figure 7.12).</p>  <p>Figure 7.12. B&amp;T, Ep.2, #56</p>

Table 7.3. Hiding and showing construction elements (C)

### 7.3.3 (SK) Thinking sketches and proof sketches

As we saw in the story of Bartolomeo and Tiziana, sketches on paper may be used by students in different phases of the proving process. Assuming that paper sketches have a different status from Cabri figures (as will be discussed in chapter 9), the use of sketches becomes a relevant category to be observed in the proving process, as the use or not of paper sketches and the phase in which they are used contribute to the development of the proving process in different ways. Table 7.4 below contains the description of the category.

<sup>7</sup> With the term 'construction elements' I refer to the elements (mainly lines) that are part of the construction required by the statement of the problem (e.g. perpendicular bisectors, angle bisectors).

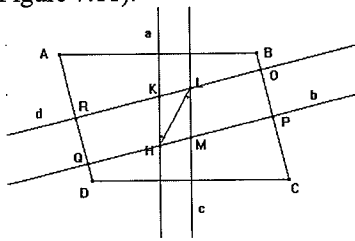
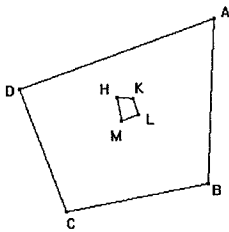
PAPER SKETCHES	Description	Examples
<b>Proof sketch</b>	When the sketch itself is used by the students as a proof. They look at the figure as a field for proving.	<p>91 Tiziana draws a rectangle on paper with the perpendicular bisectors intersecting in a point (Figure 7.13).</p> <p>92 Tiziana: ... of course it's point!</p> <p>93 Bartolomeo: sure! <b>But this is the proof ... wait...</b></p>  <p style="text-align: center;">Figure 7.13. B&amp;T, Ep.3, #91</p>
<b>Thinking sketch</b>	When students use paper and pencil as a tool to think with. The sketch may incorporate theoretical elements.	<p>434 Bartolomeo draws the perpendicular bisectors of the rhombus in Cabri.</p> <p>435 Bartolomeo: why is it so big?</p> <p>436 Bartolomeo marks the intersection points to get HKLM (Figure 7.14)</p> <p>437 Bartolomeo: is it marked?</p> <p>438 Bartolomeo goes left to see the bit of the drawing which is outside the visible part of the screen</p> <p>439 Tiziana: yes, but <b>what's that?</b></p> <p>440 Bartolomeo: well, it's a bit big!... so... a rhombus is formed ... then...</p> <p>441 Meanwhile <b>Tiziana draws a rhombus on paper</b> with the perpendicular bisectors meeting in the intersection point of the diagonals (Figure 7.15).</p>   <p style="text-align: center;">Figure 7.14. B&amp;T, Ep.8, #434</p> <p style="text-align: right;">Figure 7.15, B&amp;T, Ep.8, #441</p>

Table 7.4. Thinking and proof sketches (SK)

---

## 7.4 TYPE B CATEGORIES - TRANSFORMATIONS ON STATEMENTS

These categories (Figure 7.16) account for the transformations on statements (TS) towards the formulation of general conjectures of the form 'if...then' and the construction of proofs.

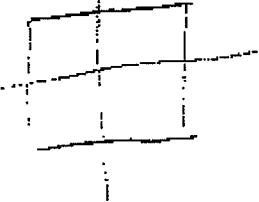
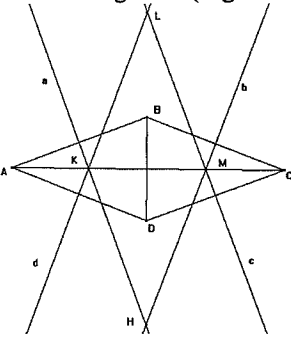
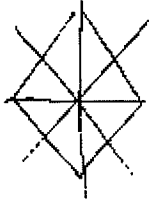
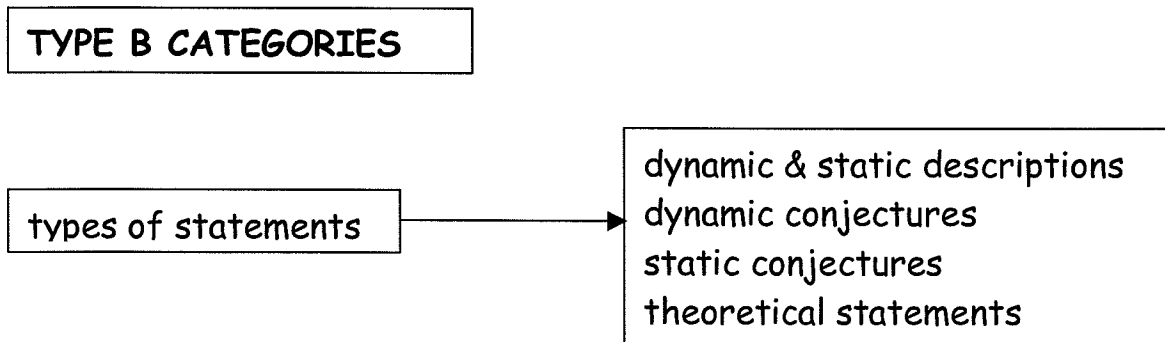

Figure 7.16. Type B categories

### 7.4.1 (ST) Types of statements

The case of Bartolomeo and Tiziana (chapter 6) has shown that the same conjecture is formulated in different ways and at different times in the proving process. What differentiates the different formulations seems to be whether they refer to relationships between elements of the figure or not and whether they are static or dynamic formulations. It is interesting to observe the evolution of the different statements produced over the process, which should lead to the final de-timed conditional form of the conjecture 'if ... then'. In fact, seeing that two things happen at the same time while dragging, and are so related, does not necessarily mean that students will transform that visual evidence into a relationship (e.g. seeing that the diagonals of a parallelogram with four equal sides remain perpendicular under dragging does not imply that students will conjecture the dependency between rhombus and perpendicular diagonals). The statements students produce (both oral and written) are distinguished according to: the linguistic formulation, if they are based on elements coming from the theoretical or spatio-graphical field, the tense used. Based on these elements, four categories for the types of statements were established, as presented in Table 7.5.

STATEMENTS	Description	Examples
<b>Dynamic &amp; static descriptions</b>	There is <b>no</b> mention of <b>relationships</b> between elements of the figure. The statements refer to particular figures. The statements come from observations in the spatio-graphical field and actions. The tense used is the present. The formulation is like 'this is .. and that is ..'.	440 Tiziana: well, it's a bit big! .. a rhombus is formed
<b>Dynamic conjectures</b>	There is reference to <b>relationships</b> between (elements of) figures. The statements mainly refer to actions. The statements may come both from the theoretical and spatio-graphical field. The tense used is either the present or the future or the past. The formulation can be: 'when ...then' or 'do', 'move', 'try to do this', 'if we did this...' It is like telling a story, i.e. describing something that is happening or will happen, a process.	79 Bartolomeo: When it's a rectangle it is always a point. ----- 231 Tiziana: Make it right angled!: 233 Bartolomeo: so another trapezium is formed.
<b>Static conjectures</b>	There is reference to <b>relationships</b> between (elements of) figures. There is no reference to actions or time. The tense used is the present. The formulation is of the form 'if...then'. The process is crystallised in a conditional static sentence, which becomes a product.	81 Bartolomeo: if it is a rectangle it is a point.
<b>Theoretical statements</b>	Statements which refer to elements belonging to the <b>theoretical field</b> , which may be known to the students already or may have been constructed during the proving process.	193 Tiziana: oh dear, the perpendicular bisectors, isn't it? There is always a right angle!

Table 7.5. Types of statements (ST)

## 7.5 TYPE C CATEGORIES - MANAGING THE TRANSFORMATIONS ON OBJECTS AND STATEMENTS

These categories refer to and are based on both transformations on objects and on statements. The categories were detailed as follows (Figure 7.17): emergent-planned interaction with the software, which accounts for the students' management of the tool; synchronous-asynchronous interaction between students, which reveals how and if the communication changes in front of the computer and what impact this has on the proving process; ascending-descending processes between the spatio-graphical field and the theoretical field, which provide a picture of the fruitful interplay of perceptual and theoretical elements.

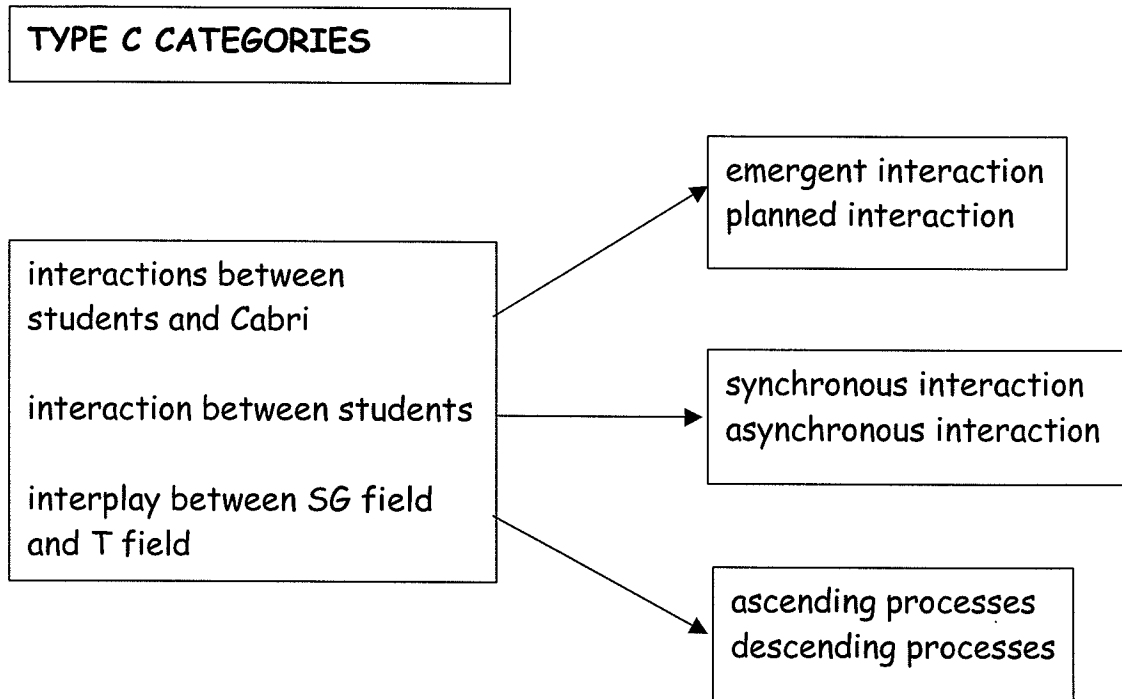

Figure 7.17. Type C categories

### 7.5.1 (SC) Emergent and planned interaction with Cabri

This category is based on the previous ones (use of dragging, use of construction elements, use of sketches and types of statements) and brings together all of them, trying to characterise more generally ways of interaction of students with the tools at their disposal (Cabri in this case). The way students interact with the computer is visible through the transformations that occur on the objects (TO) and on the statements (TS) they produce. What was observed in the story of Bartolomeo and Tiziana as far as their interaction with Cabri, can be interpreted within the framework of computers as “amplifiers” or “reorganisers”. As discussed in chapter 3 (section 3.2.2), Pea (1987) distinguished two ways of considering computers: they can be *cultural amplifiers* of the intellect, such as tools that can improve human cognitive capacities, provoking “the intensification of a signal, which does not undergo change in its basic structure” (p.94) or *conceptual reorganisers*, such as tools that imply a restructuring of the thinking activities. The way the students exploit and incorporate the computer in their solution strategies is considered relevant for the development of the proving process. Table 7.6 identifies accordingly two ways of dealing with Cabri.

<b>STUDENTS-Cabri INTERACTIONS</b>	<b>Description</b>	<b>Examples</b>
<b>Emergent interaction</b>	When the students 'read' the software without appearing to have any specific idea in mind. Ideas and statements appear to emerge from the interaction with the software, which is used to experiment and discover.	69 Tiziana makes a rectangle. 70 Bartolomeo: what have you done, a rectangle? 71 Tiziana: yes, well... 72 Bartolomeo: so... it is a point... try to make it bigger...[...] 75 Tiziana drags D up and <b>stops to observe and think</b> 76 Tiziana: excuse me! This (she points at LM) follows what this (AB) does, this (LK) follows this (AD) ... (she laughs).
<b>Planned interaction</b>	When the students carry out actions according to what appears to be a pre-specified plan. The software is used in a more controlled way without too much experimentation.	57 Bartolomeo: ok, <b>try to make it a trapezium...</b> 58 Tiziana drags D 59 Tiziana: is it a trapezium? 60 Bartolomeo: <b>let's see what happens in every case, shall we?</b>

Table 7.6. Emergent and planned interaction with Cabri (SC)

### 7.5.2 (SS) Synchronous and asynchronous interaction between the students

There is a need for microanalysis of all the interactions in a computer context, i.e. inter-pupil and pupil-computer. We need to know the outcome of the activity but also the processes by which this outcome has been achieved. We need to distinguish what the pupils are talking about - screen output, the underlying mathematical issues or the links between the two. One would hope that such an analysis might uncover significant incidents and critical decision points whereby pupils come to experience their mathematics in a different way and to see it in a new light. (Hoyles, Sutherland, & Healy, 1991, p.164)

Bartolomeo and Tiziana have shown moments in which the communication was taking place between them and moments in which they seemed to be focused on different things and not really communicating between each other. The interaction between the students is considered important as it may either support or get in the way of the evolution of the proving process. Two types of interaction were identified and the process of occurrence of each one and of transition from one to the other is found to be interesting for the development of the proving process. The different occurrences of this category are presented in Table 7.7.

INTERACTION	Description	Examples
<b>Synchronous interaction</b>	The two students 'see' the same thing on the same figure. The discourse is spoken by the two together, helping each other, interrupting each other.	61 Tiziana: wait, eh... let's do this... 62 Tiziana drags C 63 Bartolomeo: ... a parallelogram? 64 Tiziana stops moving when she gets a parallelogram 65 <b>Bartolomeo: ok, so... if ABCD is a parallelogram, then</b> 66 <b>Tiziana: this is a parallelogram too</b> 67 <b>Bartolomeo: ... that is a parallelogram too. Let's write it down.</b>
<b>Asynchronous interaction</b>	The two students look at the same figure but focus on different aspects, say different things. The two students follow different solution strategies. One student has got the mouse and the other one wants it. Indicators are for example: 'what are you doing!', 'why did you do that?', 'wait!'	366 Bartolomeo: I don't understand why you did that 367 Tiziana is about to draw another circle by mistake. Bartolomeo helps her to delete it. Then Tiziana drags B around by chance. 368 Bartolomeo: take out the circle... do this, take the circle out 369 Tiziana: no, wait, I did it wrong!... no, nothing, <b>I wanted to do ...</b> 370 Tiziana intersects the circle with all the sides of ABCD 371 Bartolomeo: <b>I don't understand what you want to do!</b>

Table 7.7. Synchronous and asynchronous interactions between students (SS)

### 7.5.3 (AD) Ascending and descending processes between the spatio-graphical field and the theoretical field

The story of Bartolomeo and Tiziana has shown that the interplay between the spatio-graphical field and the theoretical field was very important in the proving process in order to transform facts into conjectures and particular objects into generic objects. The students were observed at times to work at a spatio-graphical level only, and other times to manage shifts between the two fields. The way students make use of these two different fields is revealed by both transformations on the objects (TO) and on the statements (TS). Since Cabri figures embody both graphical and theoretical elements, as discussed in chapter 3 (section 3.4.2), the processes of transition between the two fields are revealed to be particularly interesting in this context. The two processes are described in Table 7.8.

PROCESSES <sup>8</sup>	Description	Examples
<b>Ascending process</b>	This is a process in which the students move from the SG field to the T field. The SG field works as a field of discovery, in which students perform their experiments and look for properties etc, that then have to be linked to the theory.	<p>69 Bartolomeo: what have you done, a rectangle?  70 Tiziana: yes, well...  71 Bartolomeo: so... it is a point... try to make it bigger...  72 Tiziana: eh, how can I do that?  73 Bartolomeo: just dragging!  74 Tiziana drags D up and stops to observe and think  75 Tiziana: excuse me! This (she points at LM) follows what this (AB) does, this (LK) follows this (AD) ... (she laughs)  76 Bartolomeo: let's examine some more cases  77 Tiziana drags A up  78 Bartolomeo: ah, when it's a rectangle it's always a point... (he writes down the second conjecture) ... if... shall I write "disappears" or "is a point"? It's a point...  79 Tiziana: no, because now it's a point too (Tiziana dragged B so that ABCD is not a rectangle, but HKLM is always a point)</p>
<b>Descending process</b>	This is a process in which the students move from the T field to the SG field. The SG is no longer a space for discovery but a space for validation. The theory comes into play.	<p>364 Tiziana takes the mouse and goes to "circle". She tries to make a circle with the centre in the intersection of the perpendicular bisectors (Figure 7.18)</p>  <p style="text-align: center;">Figure 7.18</p> <p>365 Tiziana: right!  367 Tiziana is about to draw another circle by mistake. Bartolomeo helps her to delete it. Then Tiziana drags B around by chance.  369 Tiziana: no, wait, I did it wrong!... no, nothing, I wanted to do ...  370 Tiziana intersects the circle with all the sides of ABCD</p>

Table 7.8. Ascending and descending processes between the spatio-graphical field and the theoretical field (AD)

<sup>8</sup> The ascending and descending processes are similar to what Laborde (in print) calls "moves between the SG and T" (p.11).

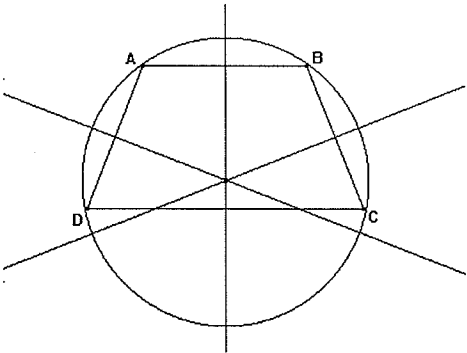

## 7.6 SUMMARY

This chapter has developed an analytical framework on the basis of a detailed analysis of one case study, developing the categories previously outlined in chapter 5, as shown in Figure 7.19.

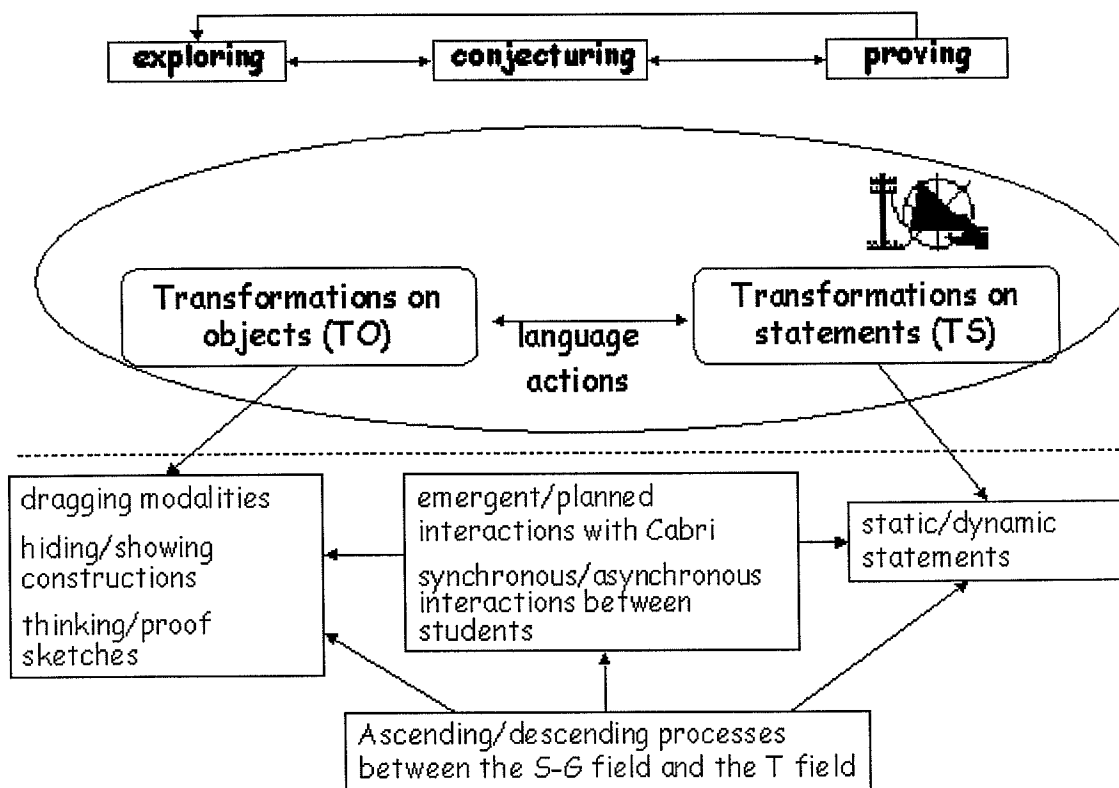

Figure 7.19. The analytical categories

Starting from this framework, what is interesting is to see is how and when these categories occur in the proving process of different students. The final aim of the thesis is to elaborate an explanatory framework to describe the proving process within a dynamic geometry environment.

Questions to be asked are:

- When do students use each dragging modality? How do they choose it and why?
- When do students hide or show construction lines? Why?
- When do students use thinking sketches or proof sketches? What for?
- How does the evolution from one type of statements to another happen?

- What is the interplay between emergent or planned interaction with Cabri? What factors influence the occurrence of each of these types of interaction?
- When do students act either in synchronised or asynchronised way? Why? How is synchronisation possible?
- What is the interplay between ascending and descending processes?

---

## CHAPTER 8. TELLING STORIES

*Teacher: what is the conjecture you're proving?*

*Tiziana: if ABCD is a square... then the other should be a rectangle...because the measures (in Cabri) show that the opposite sides are congruent, so it is a rectangle.[...] however I do not understand this, it doesn't make sense.*

*Teacher: why? What puzzles you?*

*Tiziana: because...if this is the midpoint (she points at P) then it divides this side in two equal parts (she points at AD and AP and PD). So it should be: if it is a square, the quadrilateral inside is a square too.*

*Why doesn't the figure show that?*

*Teacher: what do you trust more, that drawing or your proof?*

*Tiziana: my proof! (laughing).*

*(Tiziana, 15-year-old student, and her teacher, Italy)*

### 8.1 INTRODUCTION

This chapter provides the link between "constructing a map" and "building a theory" (Miles & Huberman, 1994, p.91). It will start off from the analytical framework laid out in chapter 7 and present the analysis of the case studies in relation to this framework. The case studies analysed<sup>1</sup> are summarised in Table 8.1.

---

<sup>1</sup> A detailed description of the case studies is set out in chapter 5 (section 5.4).

Case study	Problem <sup>2</sup>	Students	Setting
Case 1. B&T	Perpendicular bisectors of a quadrilateral	Bartolomeo & Tiziana	Italian setting
Case 2. D&G	Perpendicular bisectors of a quadrilateral	Debora & Giulia	Italian setting
Case 3. A&T	Varignon	Alessandra & Tiziana	Italian setting
Case 4. V&M&E	Perpendicular bisectors of a quadrilateral	Valentina & Michela & Elisa	Italian setting
Case 5. A&W	Angle bisectors of a quadrilateral	Alice & Will	English setting

Table 8.1. The case studies selected for the analysis

The students showed different ways of tackling the situations they were presented with and produced a different number of conjectures and proofs, as shown in Table 8.2, Table 8.3 and Table 8.4 below. This table also shows the development of the formulation of the conjectures in different cases, given that the number of each conjecture refers to the order in which it appeared in the process (e.g. C2 is the second conjecture produced or dealt with in the process). Appendixes E, F, G and H describe in detail the proving process of Cases 2, 3, 4 and 5.

Perpendicular bisectors of a quadrilateral	B&T		D&G		V&M&E	
	Cj <sup>3</sup>	Proof	Cj	Proof	Cj	Proof
If ABCD parallelogram, then HKLM parallelogram	C1	yes	C6	some hints	C2	yes
If ABCD rectangle, then HKLM point	C2	yes	C3	no		
If ABCD trapezium, then HKLM trapezium	C3	no			C11	yes
If ABCD rhombus, then HKLM rhombus	C4	some hints	C1	no		
If ABCD right-angled trapezium, then HKLM right-angled trapezium	C5	yes			C10	yes
If ABCD isosceles trapezium, then HKLM coincide	C6	no			C7	no
If ABCD is cyclic, then HKLM is a point	C7	no			C4	yes
HKLM is similar to ABCD	C8	no	C4	no		
If ABCD rhombus, then LMNP rhombus					C6	yes
If ABCD square, HKLM point			C2	no	C1	yes
HKLM coincide			C7	no		
If ABCD is convex (concave), then HKLM convex (concave)					C5	no
If ABCD triangle, then HKLM point					C8	no

Table 8.2. Conjectures and proofs for B&amp;T, D&amp;G and V&amp;M&amp;E

<sup>2</sup> The problems are presented in Appendixes A and B.

<sup>3</sup> The columns marked with Cj contain the number of the conjecture (e.g. C2) formulated by each pair.

Angle bisectors of a quadrilateral	A&W	
	Cj	Proof
If ABCD square, HKLM point	C1	no
If ABCD parallelogram, then HKLM parallelogram	C2	yes
If ABCD rectangle, HKLM square	C3	no
If ABCD kite, then HKLM point	C5	yes

Table 8.3. Conjectures and proofs for A&W

Varignon's problem	A&T	
	Cj	Proofs
LMNP is a parallelogram	C1	no
If ABCD square, then LMNP square	C4	yes
Is ABCD rectangle, then LMNP rhombus	C5	no

Table 8.4. Conjectures and proofs for A&T

All data were looked at through the categories of the analytical framework, which are summarised in Table 8.5. A table of analysis (see the example in Appendix D) was constructed for each transcript and similarities and differences came up quite vividly by comparing the tables.

Type A categories - Transformations on objects	Type B categories - Transformations on statements	Type C categories - Transformations on objects and statements
dragging modalities (DM) film/photo dragging	types of statements (ST)	emergent/planned interactions between the students and Cabri (SC)
hiding/showing construction elements (C)		synchronous/asynchronous interactions between the students (SS)
thinking/proof sketches (SK)		ascending/descending processes between the spatio-graphical field and the theoretical field (AD)

Table 8.5. The analytical categories

Table 8.6 below summarises which categories will be the specific focus of analysis for each case study in this chapter. In fact, given the large amount of data analysed, in this chapter only selected extracts from different transcripts will be discussed. I chose to include extracts that:

- represent a case in point for the behaviour of students with respect to Cabri and interactions throughout the process;
- could be compared across cases as far as some of the categories, letting similarities and differences emerge.

In general, the parts of transcripts presented constitute a unity around the construction of one conjecture and/or its proof. Some more general reference to the whole stories presented in Appendixes E, F, G and H will also be made. At the end of the chapter (p.199) the main issues from all case studies will be cross referenced. This will be the starting point of the generation of the explanatory framework.

	<b>B&amp;T</b>	<b>D&amp;G</b>	<b>A&amp;T</b>	<b>V&amp;M&amp;E</b>	<b>A&amp;W</b>
<b>Dragging modalities</b>	*			*	*
<b>Hiding/showing construction lines</b>		*		*	*
<b>Thinking/proof sketches</b>					*
<b>Types of statements</b>		*			*
<b>Emergent/planned interaction with Cabri</b>	*	*	*		
<b>Synchronous/asynchronous interaction between students</b>	*	*		*	
<b>Ascending/descending processes</b>		*	*	*	

Table 8.6. Analysis of the case studies

The chapter is divided into five sections. Each section tells the story of one case study, with particular respect to some of the categories of analysis, as discussed above. Each section contains a brief description of the context of the case study, the main categories to focus on, a number of commented extracts from the transcript of the case study and some general conclusions for the particular case study.

## 8.2 THE STORY OF DEBORA AND GIULIA<sup>4</sup> (D&G<sup>5</sup> - CASE 2)

Debora and Giulia are 15-year-old students from a second year classroom of a Liceo Psicopedagogico in Turin (Italy)<sup>6</sup>. They are low-medium achievers with respect to mathematics. They had used Cabri only once before this session. The problem given to the students was: Perpendicular bisectors of a quadrilateral (see Figure 8.1). The session took place on the 1<sup>st</sup> February 2000.

You are given a quadrilateral ABCD. Construct the perpendicular bisectors of its sides: a of AB, b of BC, c of CD, d of DA. H is the intersection point of a and b, K of b and c, L of c and d, M of a and d.

Investigate how HKLM changes in relation to ABCD. Prove your conjectures.

<sup>4</sup> The proving process of Debora and Giulia is described in Appendix E (p.312).

<sup>5</sup> Where necessary, all the case studies will be referred to with abbreviations, which stand for the initial of students' names.

<sup>6</sup> For a detailed description of the context of the Italian setting see chapter 4 (section 4.3).

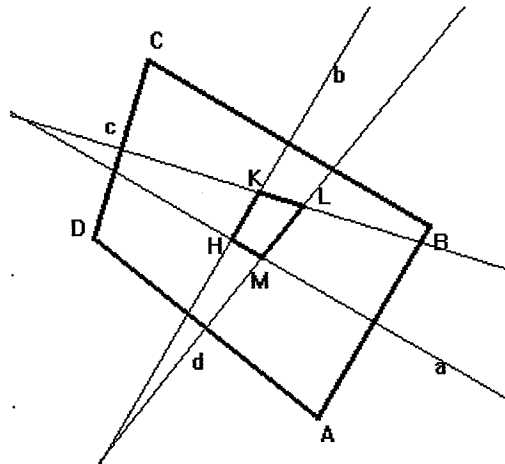

Figure 8.1. D&G. Perpendicular bisectors of a quadrilateral

The students were presented with the problem and asked to formulate conjectures and try to prove them. They were given a worksheet with the statement of the problem and were required to write the conjectures down and possibly proofs. The session lasted 1 hour and 30 minutes.

The extracts presented in this section concern the exploration towards conjectures C2 (If ABCD square then HKLM is a point), C4 (HKLM similar to ABCD), C1 (If ABCD rhombus then HKLM rhombus) and C6 (If ABCD parallelogram then HKLM parallelogram) and the attempt to prove C6. The analysis of the proving process of Debora and Giulia will focus on the following issues related to the categories of analysis.

**Hiding/showing construction elements:** the impact of leaving construction lines visible all the time throughout the process (compare with V&M&E and A&W).

**Types of statements:** how the statements produced about the studied objects are transformed from descriptions to conjectures.

**Emergent/planned interaction with Cabri:** how students are/are not able to manage the use of Cabri for their own purposes (compare with A&T).

**Synchronous/asynchronous interaction between the students:** how students interact through the mouse and shape the development of the proving process.

**Ascending/descending processes between the SG and T field:** how students interpret what happens in Cabri (SG field) and how they manage to link it up with the theory (T field) (compare with A&T).

### 8.2.1 Students' interactions and types of statements: using the mouse

At the beginning of the exploration, after constructing of the figure (1-81), different ways of dragging and different observations about the figures on the screen are made. Debora and Giulia are trying to make sense of what they have to do with the figures on the screen.

- 84 Giulia: (reading the problem) study... how HKLM changes, that is the quadrilateral in the middle, when ABC...D changes  
 85 Debora: ...if now it does not move, I'm gonna kill myself!  
 86 Debora drags segment BC with the mouse  
 87 Debora: ok, let's see how it changes, if it changes... look, **it changes!**  
 88 Debora **drags the figure fast**  
 89 Giulia: **slow!**<sup>7</sup> [...]  
 96 Giulia: I don't understand anything!  
 97 Debora: yes, it changes, but ... [...]  
 107 Debora: **if I move AB, line c stays still.** If I move BC ...  
 108 Giulia: this one should stay still (points at d) ...and in fact  
 109 Debora: if I move BC, d stays still: if I move DC, a stays still. If I move AD, ...b stays still  
 110 Debora: it changes  
 111 Giulia: thank you, but how, they want to know! ... Try ... Try to do such that ABCD becomes a rhombus.  
 112 Debora drags BC trying to make ABCD a rhombus (Figure 8.2)

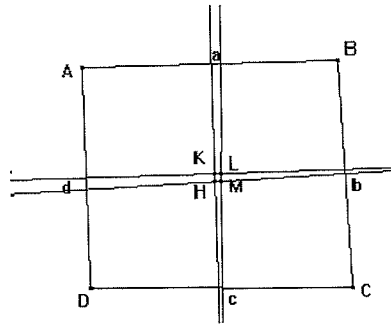

Figure 8.2. D&G, Ep.2, #111

- 113 Giulia: **ehi, stop, they all go ... try to make them coincide** [the perpendicular bisectors]  
 114 Debora: but they do not coincide perfectly, because you see ...(she points at the 4 perpendicular bisectors) ...help! Miss!  
 115 Giulia: **and this is a square, do you want to bet?**  
 116 Debora: excuse me, but **what does the perpendicular bisector divide?** ... It cuts the side in half, doesn't it? ... So this should be the midpoint  
 117 Giulia: **ah ...but I want to know if it is a square**  
 118 Debora: let's take measurements!  
 119 Debora takes the measurement of all sides of ABCD  
 120 Debora: maybe not! Look you see! They are all different!  
 121 Debora deletes measures  
 122 Giulia: **well, I don't understand** ... make CD change (Debora drags CD) ... I don't understand in which sense ...what it means ...

Extract 8.1. D&G, Ep.2, #84-122<sup>8</sup>

<sup>7</sup> Bold indicates that I want to stress that sentence which is important for the analysis.

<sup>8</sup> Each extract from the transcripts of each case study will contain the reference to the episode from which it is taken. The numbers refer to the lines in the original transcript. This gives to the reader the possibility of setting the extract in the



---

The exploration starts with a focus on the internal quadrilateral HKLM in relation to the external one ABCD (84). Wandering dragging marks the start of the exploration (86-88) and immediately provokes asynchrony between the students. Debora is controlling the figure via the mouse and wants to see how HKLM changes (87), a thing she intends to do by dragging ABCD very fast (by this kind of dragging invariants should become quite evident). However, Giulia immediately asks her to slow down (89), because she does not understand what is happening (96). This is a typical asynchronous interaction that repeatedly occurs in their proving process (see also 113): the person who has the mouse drags fast and the other person does not follow what is going on and asks the person who has the mouse to slow down<sup>9</sup>. This may suggest that the ownership of the mouse plays a very important role in students' interactions and in shaping the direction of the proving process<sup>10</sup>.

Wandering dragging goes on from 86 to 110 within an ascending process in which the students are trying to 'read' the figure. The first statements are dynamic descriptions ( $D_D$ ) of the behaviour of HKLM (87-97). The attention of the students is directed towards the behaviour of the two quadrilaterals under dragging and this leads them to observe some relationships about ABCD and HKLM as far as movement is concerned (99-109). Some dynamic conjectures are produced regarding the movement of the elements of the two figures (107, 109), i.e. all the work is done in the spatio-graphical field. As Hölzl (2001) observes, this type of observation, concerning how Cabri objects move, is the first thing that appears with students just starting to use Cabri.

The problem they have to solve is very clear to Giulia, who understands that they must discover how HKLM changes (111): she proposes a strategy, which is an ordered exploration of cases via guided dragging. She wants to transform ABCD into a rhombus (111). The focus is on the external quadrilateral. Debora starts dragging and then stops in a position in which H, K, L and M are nearly coincident (112). At this point Giulia notices a regularity and wants Debora to stop the dragging she had started (aiming at making ABCD a rhombus) and instead drag ABCD so that H, K, L and M coincide (113). The idea of the

---

proving process by referring back to the whole stories presented in Appendixes E, F, G and H. The same information is in the captions of the figures.

<sup>9</sup> See also lines 141-142 in Extract 8.2 (p.160).

<sup>10</sup> See also Extract 8.22 from B&T (p.197).

points becoming coincident is taken from the dragging itself: while observing the film on the screen (film dragging), Giulia selects a case which strikes her: it is a modality of *time section* in a dynamic exploration of the problems (see Boero, Garuti & Lemut, 1999). The focus is now on the internal quadrilateral. This is not a real point yet (Figure 8.2) but Giulia anticipates what ABCD could be when the inside quadrilateral becomes a point (115). This anticipation is based on dynamic visual elements: the figure on the screen ‘looks like’ it is being transformed into a square. Her statements do not contain conditional relationships between the two quadrilaterals and appear as descriptions of what is on the screen (“try to make them coincide -113 ... and this is a square -115”). Line 115 has the status of conjecture for Giulia, so that we can interpret the subsequent lines as a way of validating that conjecture.

A descending process starts and takes two different directions: Debora brings in a piece of theory (116) in order to explain the situation on the screen, while Giulia wants to check it in Cabri (117). The attempt to use the property of the perpendicular bisectors made by Debora is totally neglected by Giulia, and her strategy prevails, but does not lead to success (122). The attention has not moved yet to focus on the relationship between ABCD and HKLM but is still at a spatio-graphical level, focused on descriptions of what is seen on the screen. There is no theoretical control over the figure, so that Figure 8.2 cannot be seen as a square yet<sup>11</sup> and the conclusion is: “well, I don’t understand” (122).

- 123 Debora: **what do they want?**  
 124 Giulia: Miss...we didn’t understand what do you mean by study how the little square in the middle changes when ABCD changes. In what sense?  
 125 Teacher: what shape is this figure? (HKLM) ...what kind of figure is it?  
 126 Giulia: it’s a quadrilateral  
 127 Debora: **it depends on how you move it**  
 128 Teacher: exactly  
 129 Debora: so?  
 130 Debora drags BC till ABCD becomes ‘approximately’ a rectangle (Figure 8.3).

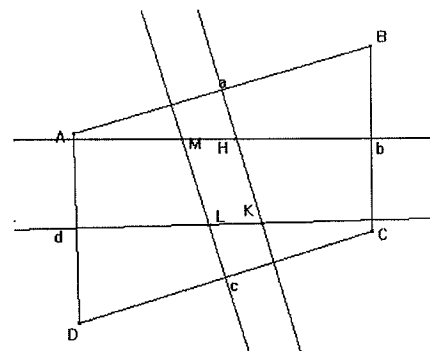
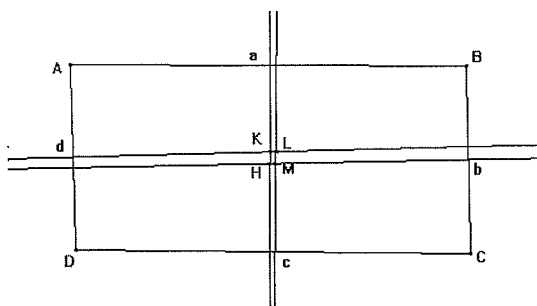

<sup>11</sup> Compare with Extract 8.10 from V&M&E (p.175).

Figure 8.3. D&G, Ep.2, #130

Figure 8.4. D&G, Ep.2, #133

- 131 Debora: **I make a rectangle like this** (points at ABCD in a horizontal position) **and here it becomes vertical** (points at HKLM). I make a rhombus here like this (drags BC till ABCD becomes a rhombus and points at it in an oblique way) ...and here it becomes like that (points at HKLM).
- 132 Teacher: This is the problem: how one changes as a function of the other one.
- 133 Debora: **I make it like this and the one inside becomes** ... (uses her hands on the screen, points at ABCD from right to left and from bottom to top, and HKLM from left to right and from top to bottom - Figure 8.4) ...but I don't know how to explain this...
- 134 Giulia: try the rectangle, do it again ...
- 135 Debora drags BC till ABCD becomes 'approximately' a rectangle [...]
- 137 Giulia: do such that it becomes a little rectangle there in the middle ...
- 138 Debora: look, **if I do it like this, that one becomes like that** (uses her hands on the screen)
- 139 Giulia: try to make another figure ...
- 140 Debora drags CD leftwards
- 141 Debora: no, this thing doesn't matter...wait, I go back
- 142 Giulia: **no!** Try to make it go outside [...]
- 146 Debora tries to make ABCD a square by dragging CD slowly [...]
- 148 Debora: **anyway then they coincide**, you can't see what's in the middle! ...I don't understand ... (stops dragging -Figure 8.5) ... then what do they say?

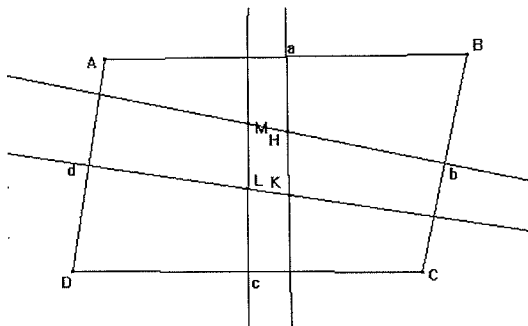

Figure 8.5. D&G, Ep.2, #148



Figure 8.6. D&G, Ep.2, #152

- 151 Giulia: conjectures! The problem is that we didn't make any conjecture!
- 152 Giulia **draws a sketch on paper** (Figure 8.6)
- 153 Giulia: **I can't see anything** ...Miss...help. Well, we can't ... I don't understand, well...I can't ... I can't find the relationship between ...

Extract 8.2. D&G, Ep.2, #123-153

After the exploration carried out in the previous extract (Extract 8.1), which was fast and seemingly unreflective, the students are now trying to understand what they have to do. They call the teacher (124). The attention is still focused on movement (127), but this is the basis to identify a relationship between ABCD and HKLM, which in Cabri are linked via dragging. An episode of guided dragging follows (130-148) with the aim of discovering a relationship. All the statements Debora makes while dragging are still dynamic descriptions, which describe what she is doing and what appears on the screen as a consequence of the movement ("I make it like this and the one inside becomes ..." -131, 133). These are then transformed into dynamic conjectures ("if I do ... that one becomes

...” –138). Visual elements are very strong. The direction is from the outside (ABCD) to the inside (HKLM), i.e. setting hypotheses on ABCD and see what happens to HKLM, within an ascending process. In 134 Giulia goes back to Figure 8.3, which is the same configuration she started considering in the previous phase (see Figure 8.2). From 134 to 147 Giulia, who does not have the mouse, tries to direct the process in the direction she wants, but Debora, who has the mouse, keeps following her own line of thoughts. There is clear asynchrony between the two. At the end of this phase Giulia draws a sketch on paper (151), which is a thinking sketch. This can be seen as an alternative to Cabri, in a moment in which the students are stuck and do not know what to do in Cabri, and it is probably due to the fact that she does not have the mouse and cannot try things out herself.

### 8.2.2 Showing construction lines: a proof linked to the spatio-graphical field

The students leave the construction lines visible all the time. This extract shows how this affects their attempt to prove a conjecture which is based on visual elements only.

- Debora has the mouse.
- 189 Debora keeps dragging CD randomly (Figure 8.7).
- 190 Debora: this is congruent to this (Ac'Mb' and Kd'Ca')<sup>12</sup>, this is congruent to this (aBbH and DcLd) this is congruent to this (Hbd'K and MLdb') this is congruent to this (c'aHM and Lka'c)
- 191 Giulia: **the figures internal to the quadrilateral, excluding HKLM, are congruent in pairs respectively**
- 192 Debora: the opposite are congruent [...]
- 234 Debora: I'm trying to understand from which point to look at it (drags C - Figure 8.8) if this one ... then it becomes something like that. I can't understand which are the biggest sides ... **ah, it's upside down!**
- 235 Giulia: it's upside down
- 236 Debora: excuse me, eh ... isn't the perpendicular bisector that thing which ... (draws a sketch on paper - Figure 8.9). Suppose you have a triangle here ..here you have a triangle and you have it in a mirror ... like that. So if you look at it here (points at the screen) this one (HKLM) is the image in the mirror of this one (ABCD). [...]

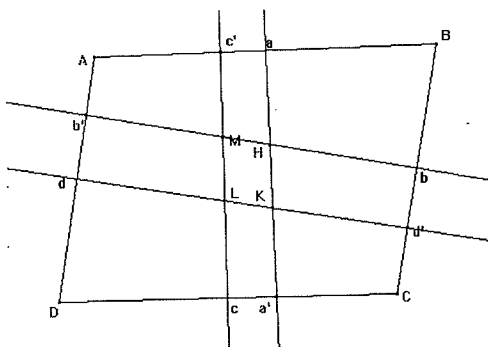

Figure 8.7. D&G, Ep.3, #189

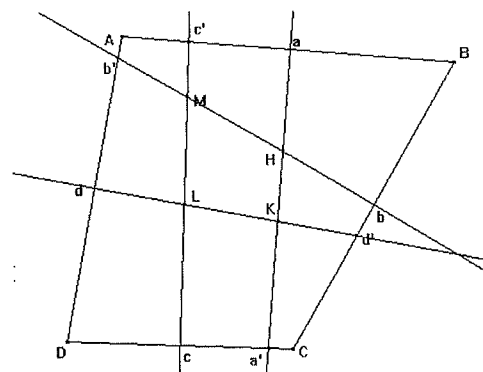

Figure 8.8. D&G, Ep.3, #234

<sup>12</sup> a, b, c, d, a', b', c', d' are used by the students to indicate the intersection points of the perpendicular bisectors with the sides of ABCD.

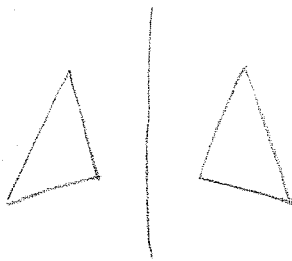

Figure 8.9. D&G, Ep.3, #236

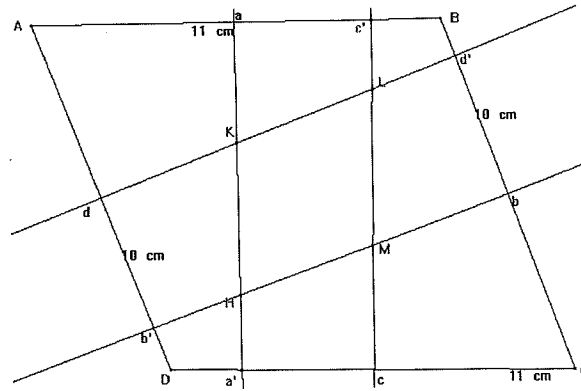

Figure 8.10. D&G, Ep.3, #442

442 Giulia: **so, proofs.** We must prove it is an upside down rhombus (Figure 8.10) ...here is the story ... the congruence stuff. So, let's start from the things we know. We know that this bit (points at Bb with fingers) equals this bit (bC) because this one (b) is a perpendicular bisector... this bit (points at Cc with fingers) equals this bit (cD) because this one (c) is a perpendicular bisector, this bit (points at Dd with fingers) equals this bit (dA) because this one (d) is a perpendicular bisector, this bit (points at Aa with fingers) equals this bit (aB) because this one (a) is a perpendicular bisector. Let's start from these two big figures: this one (Ac'Ld) and this one (Ha'Cb). Can you see them? So, we know that this bit (AdKa) equals this bit (Lc'Bd'), this bit (HcCb) equals this bit (Ha'Db'). No!...no! We must change figure, but the problem is that we can only consider those figures!

Extract 8.3. D&G, Ep.3, #189-192, #234-236, #442

The students' exploration up to this moment happens within the spatio-graphical field and it is an ascending process. They are trying to 'read' the figure and the statements they produce are dynamic descriptions of facts which can be observed on the Cabri figure (190-192). The statement "it's upside down" (234-235) is a static description based on a visual reading of the figure, which follows up from statements 131, 133 and 138 from Extract 8.2 (p.160). All these statements actually express a very general conjecture (HKLM similar to ABCD), but the students do not recognise this and keep talking about the link between ABCD and HKLM only in terms of visual properties.

Debora brings in a piece of theory<sup>13</sup> (236), which however is not appropriate to the situation (perpendicular bisectors are confused with the mirror line in a reflection). 442 is the starting point of the proof for conjecture C1 (If ABCD rhombus then HKLM rhombus). As we can see, what they want to prove is exactly what they focused on in the exploration, that is the

<sup>13</sup> Throughout the whole process it is always Debora who brings in any reference to theory.

congruence of the quadrilaterals formed inside ABCD and external to HKLM<sup>14</sup>. This focus does not lead them anywhere, and they remain at a spatio-graphical level for a long time, without succeeding in constructing a proof. The particular focus the students choose seems to be due to the fact that they leave the perpendicular bisectors visible. In fact, looking at the figure with all the lines visible, what appears very strongly is this multitude of little quadrilaterals in which the figure is split into and it is more difficult to have a global vision of the two quadrilaterals ABCD and HKLM only.

### 8.2.3 Ascending/descending processes and emergent/planned interaction with Cabri: a change in focus

Here the students decide to prove conjecture C6 (if ABCD parallelogram then HKLM parallelogram). While doing this, a conflict between what they see on the screen and what they believe is true occurs and the help of the teacher is needed in order to solve it.

They drag the quadrilateral ABCD until they get a parallelogram.

- 542 Debora: (looking at Figure 8.11) so if ABCD is a parallelogram, HKLM is a parallelogram. Hypothesis: AB parallel and congruent to DC and AD parallel and congruent to BC. Thesis: KL parallel and congruent to HM, KH parallel and congruent to LM.

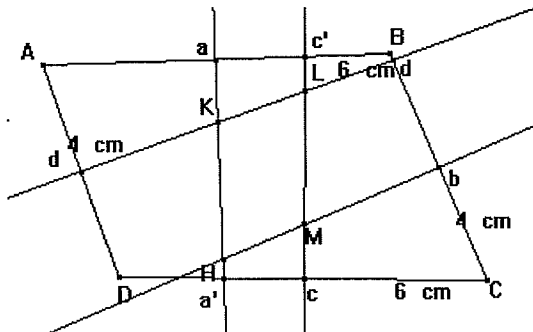

Figure 8.11. D&G, Ep.7, #542

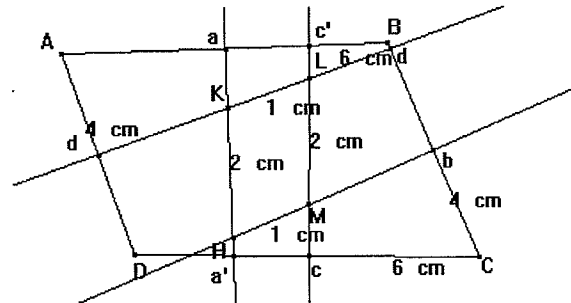

Figure 8.12. D&G, Ep.7, #545

- 543 Debora: but you can see that it's... wrong.  
 544 Giulia: no, it's right, try with measures!...you must define the segments.  
 545 Debora takes measurements of the sides of HKLM (Figure 8.12).  
 546 Debora: look at the measurements, it's right! End of the story! The proof is finished!  
 547 Giulia: well...in order to prove they are congruent we need to prove that the figures... [...]  
 549 Giulia: are congruent!...of course...and then parallel, I have no idea how we can prove they are parallel! [...]  
 551 Debora uses 'parallel line' and constructs the line parallel to d and going through M.  
 552 Debora: they are not parallel...ok, they are not parallel.  
 553 Debora deletes the line.  
 554 Debora: why aren't you parallel?...let's see if the sides of the initial figure (ABCD) are parallel...I'm worried about that!  
 555 Debora draws the line parallel to AD and going through B.

<sup>14</sup> Compare with the Extract 8.21 (p.193) from A&W.

---

556 Debora: actually...it's parallel...  
557 Giulia: well, but the other one as well...  
558 Debora draws the line parallel to AB and going through C.  
559 Debora: look. It's not...parallel  
560 Giulia: **then there's nothing to prove...it's all wrong!**  
561 Debora: I have no idea!  
562 Giulia: neither do I!  
563 Debora: those are not parallel, the sides are not parallel...there is still one  
thing missing: the angles! Let's measure the angles!  
564 Debora measures the angles A, B, C and D.  
565 Debora: They are not congruent...it's all wrong!  
566 Debora deletes measures.

Extract 8.4. D&G, Ep.7, #542-566

The conjecture about the parallelogram was formulated while dragging. The use of Cabri at that stage was visual, because the students got the idea of the parallelism of some sides of the quadrilaterals only by observing the constructed figure. At this point the students search for a validation of their conjecture within Cabri, through the use of measures (544). According to Debora, once they have checked that the measures of the sides of HKLM correspond to (one of) the requirements of the thesis (which was previously formulated), the proof is finished (546). An ascending process starts here, in which the validation occurs within the spatio-graphical field (Cabri figure). Debora uses the construction of parallel lines in order to check whether HKLM is a parallelogram, that is in order to check if the thesis is correct (551). This test tells her that lines d and b are not parallel. In this case the checking does not support the conjecture previously formulated within Cabri. This provokes Debora to ask "Why aren't you parallel?" (554). She seems to rely on her conjecture and try to understand the answer given by the software, which contradicts what was previously seen and formulated. There is no theoretical control over the figure, which is not a 'real' parallelogram because it has not been constructed as such. This episode provokes a chain reaction: since the thesis appears to be wrong, the students go and check if the hypothesis is correct, i.e. if ABCD is a parallelogram (554). Their reasoning is mathematically correct, but it is not supported by a correct interpretation of the particular construction in Cabri. The way they use Cabri is visual, not connected with the theory. We can say there is an emergent interaction with Cabri, because they 'read' the software and try to make sense of what they see, without a pre-specified plan or interpretation. The conflict grows in the students' minds. They check the parallelism of the opposite sides of ABCD (i.e. the hypothesis), and, by looking at the Cabri drawing, they realise the sides are not parallel, so they conclude that the hypothesis does not hold either. For them the end of the story is that "it's all wrong" (560). As a last resort, they check the congruence of the angles of ABCD, that is they check another property that should hold for ABCD to be a

parallelogram and they get the same result: “they are not congruent” (565), because their measures are different. The students trust constructions (parallel sides) and measures (equal angles), so they come to the conclusion that their conjecture must be wrong (565). The Cabri figure does not correspond to the geometric properties a parallelogram should have from a theoretical point of view, because it has not been constructed as such. In this case the use of measures and constructions in Cabri works against the validation of the conjecture. At this point the students are stuck, because they are presented with a conflict between a conjecture, discovered in Cabri, and a refutation of this conjecture, discovered in Cabri too. The work within the spatio-graphical field has produced two different answers: how to solve the conflict? The conflict can be solved only by a change in the way of looking at the situation.

- 571 Giulia: **miss!**  
 572 Teacher: so, what’s the problem?  
 573 Debora: we tried with angles, they are not congruent! ...  
 574 Teacher: but you had a conjecture, which was not bad at all ...  
 575 Giulia: but it’s all wrong!  
 576 Teacher: well, if I’m not wrong, **your conjecture was: if ABCD is a parallelogram, then HKLM ...**  
 577 Giulia: **but the fact is that ABCD is not a parallelogram!**  
 578 Teacher: **but can you make ABCD a parallelogram?**  
 579 Giulia: but I need to have opposite sides parallel!  
 580 Teacher: and can you do this?  
 581 Debora: yes...but ...I mean, you don’t use the initial figure any more  
 582 Giulia: you need another one!  
 583 Debora: I mean, you need to put the line parallel to this one (points at BC)  
 584 Teacher: (takes the mouse) **you can make a figure which has approximately parallel sides ...this one will do!**  
 585 Debora: **but they are not parallel ...shall we do as if they were parallel? ...**  
 586 Teacher: yes, you made a conjecture saying that if ABCD is a parallelogram then HKLM is a parallelogram. right? Can you prove it? If you can find a proof then what you’re saying it’s true  
 587 Debora: who knows, we’ll try  
 588 Giulia: I don’t think so  
 589 Debora: **if we do as if that one was a parallelogram, we’ll make it!**

Extract 8.5. D&G, Ep.7, #571-589

The students call the teacher (571) to understand how to deal with a figure that is supposed to be a parallelogram, but it is not a parallelogram in Cabri. The figure observed by the students is still the same, but it changes status and it is now seen as a *generic object* (in the sense of Balacheff, 1999), which has the mathematical properties of a parallelogram, even if on the screen it does not look like a parallelogram: “shall we do as if they were parallel?” (584). The students are prompted to construct a proof (585) in order to validate their conjecture, rather than trusting the visual feedback of Cabri. They use Cabri in a theoretical-general way.



---

While in the previous extract (Extract 8.4, p.164) the students used mainly words indicating facts (equal, parallel), in this last part of the protocol many words refer to theoretical assumptions (do *as if* they were parallel; *as if* that was a parallelogram). These words are indicators of a change of process: they are now in a descending process in which the same figure is looked at from another point of view, i.e. from the point of view of the theory. The fact that the figure on the screen is not a 'real' parallelogram does not matter now because the students have theoretical control over the figure and they can "do as if" that was a parallelogram, i.e. using all the properties a parallelogram has. The fact that the teacher does not exploit the possibility of constructing a new quadrilateral which is a 'real' parallelogram in Cabri (i.e. constructed according to its properties) has very important consequences. In fact, this decision is what makes the students change the way they look at the figure on the screen: from a particular object, that figure is transformed into a generic object that they control through its properties. ABCD is a parallelogram *because* it has opposite parallel sides, even if the Cabri figure does not show that.

The main points from this analysis are:

- Debora and Giulia leave construction lines visible all the time. This clearly affects their proving process, in particular as concerns the visual impact of the Cabri figure on conjecturing and proving, which are based on the same elements.
- Generally speaking, D&G show an emergent interaction with Cabri, in the sense that the visual impact of figures on the screen plays an important role and a theoretical interpretation of it is found to be difficult.
- At the beginning of the exploration, the ownership of the mouse plays an important role in the interaction between the students. Debora, who has the mouse, directs the proving process, but is continuously stopped by Giulia, who tries to tell her what to do.
- D&G work in the spatio-graphical field most of the time and do not succeed in moving to a theoretical control of the situation until the end of the proving process and thanks to the intervention of the teacher. Descending processes occur mainly within the spatio-graphical field and theory does not have a clear role. However there are many shifts between ascending and descending processes.

### 8.3 THE STORY OF ALESSANDRA AND TIZIANA<sup>15</sup> (A&T - CASE 3)

Alessandra and Tiziana are 15-year-old students from a second year classroom of a Liceo Psico-Pedagogico in Turin (Italy)<sup>16</sup>. They are medium achievers with respect to mathematics. They had used Cabri only once before this intervention. The problem given to the students was: Varignon's problem. The session took place on the 26<sup>th</sup> April 2000.

Draw any quadrilateral ABCD. Draw the midpoints L, M, N, P of the four sides.

1. Which properties does the quadrilateral LMNP have?
2. Which particular configurations does LMNP assume?
3. Which hypotheses on the quadrilateral ABCD are needed in order for LMNP to assume those particular configurations?

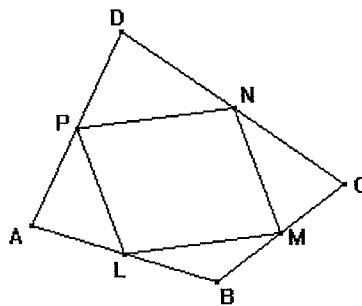

Figure 8.13. A&T. Varignon's problem

The students were presented with the problem and asked to formulate conjectures and try to prove them. They were given a worksheet with the statement of the problem and were asked to write conjectures and proofs down. The session lasted 1 hour and 25 minutes.

The extracts presented in this section track the generation of the conjecture C4 (If ABCD square then LMNP ...) and its proof. The analysis of the proving process of Alessandra and Tiziana in particular focuses attention on the following issues.

**Emergent/planned interaction with Cabri:** how students are/are not able to manage the use of Cabri for their own purposes (compare with D&G).

**Ascending/descending processes between the SG field and the T field:** how students manage the interactions between ascending and descending processes in the generation and validation of conjecture C4 and its proof (compare with D&G).

<sup>15</sup> The proving process of Alessandra and Tiziana is described in Appendix F (p.319).

<sup>16</sup> For a detailed description of the context of the Italian setting see chapter 4 (section 4.3).

### 8.3.1 Ascending/descending processes and emergent/planned interaction: a change in focus

At the beginning the students construct in Cabri a generic quadrilateral ABCD and the quadrilateral LMNP with the vertices in the midpoints of ABCD (Figure 8.14). The following extracts follow the development of the conjecture about the square and its proof, focusing on the conflict between the proof constructed in the theoretical field and the Cabri feedback from the spatio-graphical field.

- Tiziana has the mouse
- 16 Alessandra: Try to take measurements of the sides, it seems that that equals that (she points at LM and NP) and that equals that (PL and MN).
- 17 Tiziana: yes, it is a ...
- 18 T moves C and stops to observe the figure.
- 19 Tiziana: it is ... a parallelogram
- 20 Tiziana puts measures on the sides of LMNP (Figure 8.15).
- 21 Tiziana so...
- 22 Alessandra: so the opposite sides are...
- 23 Tiziana: congruent...eh... [...]

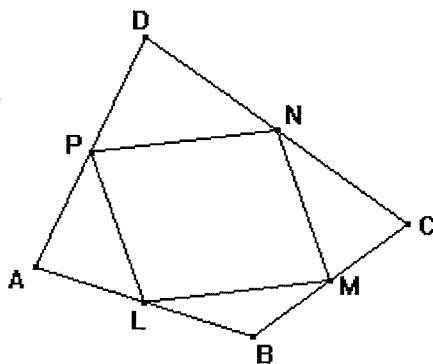

Figure 8.14. A&T, Ep.2, #15

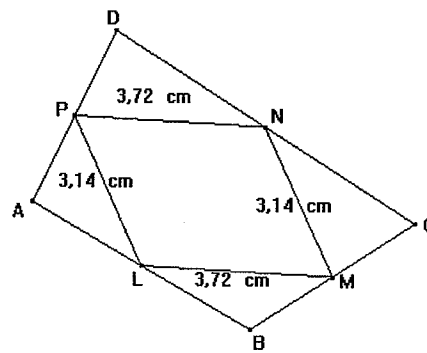

Figure 8.15. A&T, Ep.2, #20

- 38 Tiziana: so... it may be a rhombus
- 39 Tiziana drags B slowly on the left and slows down when it seems she is getting a rectangle.
- 40 Tiziana: it may also become a rectangle!
- 41 Alessandra: **try to make this (ABCD) a square.** Let's see what quadrilateral it (LMNP) becomes.
- 42 Tiziana: **So I need to put measures.**

Extract 8.6. A&T, Ep.2, #16-42

At the beginning, the students start dragging the vertices of ABCD, observing that the opposite sides of LMNP seem to be congruent (16) and they want to check this observation by taking measurements of the sides of LMNP (16). However, first an observation is made about LMNP being a parallelogram (19), then measures are used in order to have more information supporting this conjecture (22-23). Measures and dragging are used within an ascending process, in order to discover a conjecture. In the second phase, the students observe some more regularities in LMNP while dragging and express them as descriptions: it may be a rhombus (38) and a rectangle (40). They pay attention to ABCD as well and try

to relate the two quadrilaterals (41). In order to make ABCD a square they first measure the sides of ABCD (42). They use guided dragging together with measurements in order to achieve a square.

After having explored the situation and formulated some conjectures, they start proving conjecture C4 -if ABCD is a square then LMNP is a rhombus<sup>17</sup>, which was discovered by dragging ABCD into a square via guided dragging and observing the measurements of the sides of LMNP.

- 178 Tiziana draws on paper a square ABCD with the sides 12 squares length, puts the midpoints of the sides and gets the internal quadrilateral LMNP (Figure 8.16).[...]
- 181 Tiziana: all this stuff...these...they are congruent (the halves of the sides of ABCD). Then Tiziana writes down the thesis: LM equals MN, equals NP, equals PL. Meanwhile Alessandra uses a ruler to measure the sides of LMNP. [...]
- 186 Tiziana writes down "let's consider triangle ALP and triangle MCN"
- 189 Tiziana: so NC is congruent to... MC... PAL (angle) is congruent to NCM (angle) because ABCD square (she writes down all this). And so it has got right angles, right? (she marks the right angles in ABCD). We didn't write this in the hypothesis, but ...shall I explain this?
- 193 Tiziana: so PL equals MN. The same for ...PDN triangle and LBM triangle then PN equals LM...Should I do a cross comparison? PDN triangle and PAL triangle then PN equals PL. What's missing? These two are done, these two are done.... [...]
- 195 Tiziana: NCM triangle and MBL triangle so NM congruent to ML
- 197 Tiziana: **They all have equal angles. So it is a rhombus! OK!**

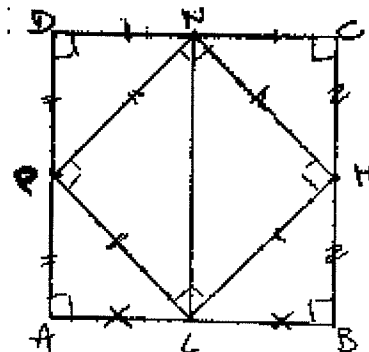

Figure 8.16. A&T, Ep.5, #178

Extract 8.7. A&T, Ep.5, #178-198

In order to get started with the proof, Tiziana makes a drawing on paper. The procedure to get a square is the same as the one used in Cabri: taking measurements of the sides (178). The proof is produced with a deductive reasoning, using the congruence of the triangles in which the figure is decomposed (193). At the end of this reasoning the students are convinced of the validity of their conjecture (198) from a logical point of view, because they proved it. They work within the theoretical field, as they construct the proof according to the deductive rules of mathematics: they deduce the thesis (rhombus) from the

hypothesis (square), connecting all the steps with logical consequence. However, "there is profound difference between determining that something is true and explaining why it is true" (Nunez, 2000, p.3).

- 207 Tiziana: **try to make ABCD a square**  
 208 Alessandra drags A and B trying to obtain a square with a side of 6.17  
 209 Tiziana: is it a rhombus?  
 210 Alessandra: well...(Alessandra points at the sides of LMNP). A rhombus has got equals sides...**oh no! ...It's not a rhombus!** (Figure 8.17) [...]  
 216 Tiziana: then... it's a square, I mean a rectangle, ok?...so... then: it has got congruent sides, and we proved that. Now we need to prove that ... its angles are congruent?  
 220 Tiziana: no, these ones: if it is a rectangle, it has got opposite sides...  
 221 Alessandra: ah, that's true... so...  
 222 Tiziana: so, we need to go on. PL is... PL is not congruent to PN (~~deletes the thesis~~ she had written down on paper and writes PN congruent to LM, NM congruent to PL). So PN... LM... (~~deletes the part of the proof~~ related to the congruence of PN and PL)... but... you know what's the problem?  
 223 Tiziana drags B.  
 224 Alessandra: what have you done?  
 225 Tiziana: **the problem ...is that this is not a square (ABCD).**  
 226 Alessandra: it's impossible.  
 227 Tiziana: look... no... Because if you say that this equals this (PD and DN in Figure 8.16) and you say they have an equal angle (D) and then this equals this (PN and LM) and this and this (PL and MN)...then this becomes a square (LNMP), but we've just seen that it is not a square. So it's all wrong![...]

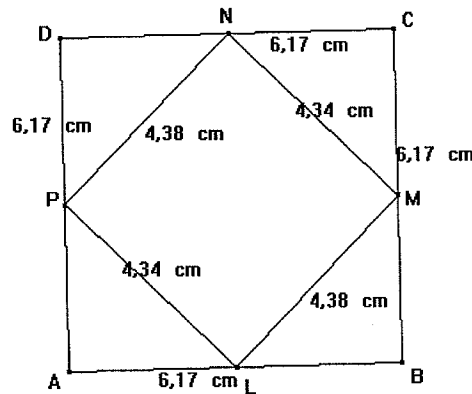

Figure 8.17. A&T, Ep.6, #211

Extract 8.8. A&T, Ep.6, #208-227

The students feel the necessity of validating their deduction in Cabri. So they go back to Cabri and drag ABCD into a square (207), in order to check if LMNP is a rhombus and they measure the length of the sides of LMNP. The students are now using Cabri in a descending process, where figures are a field for validation. They have a theoretical

<sup>17</sup> It is true that if ABCD is a square then LMNP is a rhombus but there is more to it, because LMNP is a square too, because its sides are not only equal but also perpendicular to one another.

deduction, which holds within geometry; however they are seeking an explanation for that and they want to understand why is that so. They are unhappy when they see that the measures do not corroborate their thesis (210). A conflict arises<sup>18</sup>, as from a logical (theoretical) point of view they came to one conclusion, but the empirical point of view does not corroborate it. So the experimental validation provokes a conflict. These students' attitude towards Cabri seems to be of complete trust, and as such it is a case of emergent interaction. They immediately go back to their proof and check each deductive step very carefully, thinking there may be something wrong there. They conclude by rejecting that proof (227) and they delete part of it (222). The motivation for this is that the figure in Cabri does not look like a square (227): at this moment visual elements are very strong and prevail over theoretical considerations (the Cabri figure is not a square because the angles are not right angles). This seems to be a final decision, however the conflict is not yet solved for them.

- 250 Teacher: what is the conjecture you're proving?  
 251 Tiziana: if ABCD is a square... then the other should be a rectangle...because the measures (in Cabri) show that the opposite sides are congruent, so it is a rectangle. [...]  
 257 Tiziana: however I do not understand this, it doesn't make sense.  
 258 Teacher: why? What puzzles you?  
 259 Tiziana: because...if this is the midpoint (she points at P) then it divides this side in two equal parts (she points at AD and AP and PD). [...]  
 263 Tiziana: **so it should be: if it is a square, the quadrilateral inside is a square too.**  
 264 Teacher: right!  
 265 Tiziana: **why doesn't the figure show that?**  
 266 Teacher: what do you trust more: that drawing or your proof?  
 267 Tiziana: my proof! (laughing). [...]  
 270 Alessandra: however looking at the proof, if we say that all these sides are congruent (points at all the halves of the sides of ABCD), then all these triangles should be congruent (points at the triangles on paper) and all these sides (points at the sides of LMNP) should be congruent [...]  
 274 Teacher: I'll try to pose the problem from a different perspective: **this figure (points at the figure on the screen), is it a square? Really?**

Extract 8.9. A&T, Ep.7, #251-264

The conflict is recognised by the students (257). It is interesting to notice that Tiziana starts explaining to the teacher what the figure and the measures in Cabri (251) show (LMNP rectangle) and not what they got in the proof (LMNP rhombus). The use of conditional sentences (251) shows that she does not really give the status of truth to this fact. Tiziana goes back to the proof again; this time she reconstructs it on the figure without reading the

<sup>18</sup> Compare with Extract 8.4 from D&G (p.164).

---

one they constructed before. Her conclusion is a conjecture (263), which is different from the one the figure shows (265). This time she seems to be more convinced of the proof, as she is asking why the figure does not show what she has just proven true (262). The teacher's intervention focuses the attention on the two aspects of empirical validation and theoretical proof, i.e. she tries to link the spatio-graphical field (Cabri drawing<sup>19</sup>) and the theoretical field (proof). The way the teacher decides to help the students to solve the conflict is to make them realise that the figure they have on the screen (Figure 8.17) is not a square for Cabri. She prompts them to construct a 'real' square in Cabri and, after doing that, the students see that the figure shows what their conjecture and proof say<sup>20</sup>.

The evolution of the proving process the students carried out with respect to the proof of conjecture C4 can be summarised as follows.

- First, the students explore the situation in Cabri, make a conjecture, they are convinced of that conjecture and they prove it: the conclusion is that the conjecture holds.
- Second, they want to better understand the situation and they want an explanation for their conjecture; so they go back to Cabri. This experiment does not confirm their proof.
- So, at first they refute the proof; then they re-construct the proof, and they seem to be convinced by that. However, the figures in Cabri still do not validate it.

What is the problem? A conflict (265) between the theoretical result (proof) and the empirical answer given by Cabri (the figure does not look like a rhombus) arises. This happens because the students, in their descending process, try to validate the proof at an empirical level. This requires looking at the figure from another point of view, not only empirical, but also theoretical. When validating the proof the pupils 'read' the figure at an empirical level (210), in the same way as at the beginning of the ascending process. They 'read' the properties of ABCD from the measurements on the figure, concluding that ABCD is a square because it has equal sides. And in the same way they 'read' the properties of LMNP from the measurements: it has not equal sides therefore it cannot be a rhombus. The students do not consider that their hypothesis is *ABCD square* while the Cabri figure is not a square because the angles are not right angles. Instead of 'reading' the Cabri figures, they should have looked at them from a theoretical point of view, according to which ABCD is

---

<sup>19</sup> It is not a figure, because the square on the screen was not constructed using the properties of a square.

<sup>20</sup> Compare with Extract 8.5 (p.165) from D&G.

an 'approximation' of a square and LMNP is an 'approximation' of a rhombus<sup>21</sup>. The proof would have then been validated.

The main points of this analysis are:

- The construction of conjecture C4 and its proof involves the use of both Cabri and paper and pencil in an interrelated way which creates a conflict in the students. Figures on paper are precise and correctly interpreted while Cabri figures are not precise and not correctly managed and interpreted.
- The interactions between ascending and descending processes are crucial in the generation of conjecture C4, with particular respect to the interpretation of the spatio-graphical field from a theoretical point of view.

#### 8.4 THE STORY OF VALENTINA, MICHELA AND ELISA<sup>22</sup> (V&M&E - CASE 4)

Valentina, Michela and Elisa are 17-year-old students from a fourth year classroom of a Liceo Scientifico in Finale Ligure (Italy)<sup>23</sup>. They are medium-high achievers with respect to mathematics. They had used Cabri for one year before this intervention. The problem given to the students was: Perpendicular bisectors of a quadrilateral (see Figure 8.1). The session took place on the 9<sup>th</sup> February 2000. The students were presented with the problem and asked to formulate conjectures and try to prove them. They were given a worksheet with the statement of the problem but were not explicitly asked to write conjectures and proofs down. The session lasted 1 hour and 30 minutes.

The extracts presented in this section track the generation of the conjecture C4 (If ABCD cyclic, then A'B'C'D' point), from the first moment in which it came up as a particular case (C1) to the construction of a proof for C4. The analysis of the story of Valentina, Michela and Elisa focuses attention on the following issues.

**Dragging modalities:** The students use of a variety of dragging modalities, which match their strategies at different moments of the proving process and is used with a precise aim. In particular, wandering dragging marks a change of focus and is the starting point of a new episode.

<sup>21</sup> Compare with Extract 8.5 9 (p.165) from D&G ("shall we do as if they were parallel?" –585).

<sup>22</sup> The proving process of Valentina, Michela and Elisa is described in Appendix G (p.330).

<sup>23</sup> For a detailed description of the context of the Italian setting see chapter 4 (section 4.3).



**Hiding/showing construction lines:** the students leave construction lines visible throughout the proving process and this has a strong impact on the way they construct conjectures and proofs (compare with A&W).

**Synchronous/asynchronous interaction between students:** the interactions between the students while constructing a proof show moments of asynchrony which then converge towards synchrony, thanks to a common language the students share within the Cabri space.

**Ascending/descending processes:** there is a productive alternation and interaction between ascending and descending processes, which show an integration of spatio-graphical (Cabri) and theoretical elements (geometrical properties) while constructing conjectures and proofs (compare with D&G and A&T).

#### 8.4.1 Synchronous and asynchronous interactions together with ascending and descending processes: a rich proving process

From 1 to 57 the students construct the figure in Cabri. The following extracts show how they generate the conjecture about the square and how they prove it, integrating SG and T.

- Elisa has the mouse  
 58 Michela: I don't know, **maybe we could start with the square**, so we can see  
 59 Elisa drags B, C and D to get a rectangle.  
 60 Valentina: **properties of perpendicular bisectors?**  
 61 Elisa: perpendicular bisectors, what was that?  
 62 Michela: so ... the perpendicular bisector goes through the midpoint of...  
 63 Elisa: it's perpendicular!...  
 64 Michela: ok  
 65 Elisa: well, in the square, in the...  
 66 Elisa takes measurements of the sides of ABCD (Figure 8.18), then drags C and then B randomly

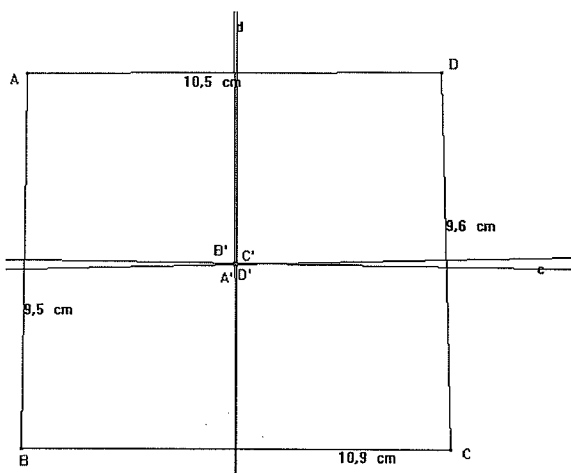

Figure 8.18. V&M&E, Ep.2, #66

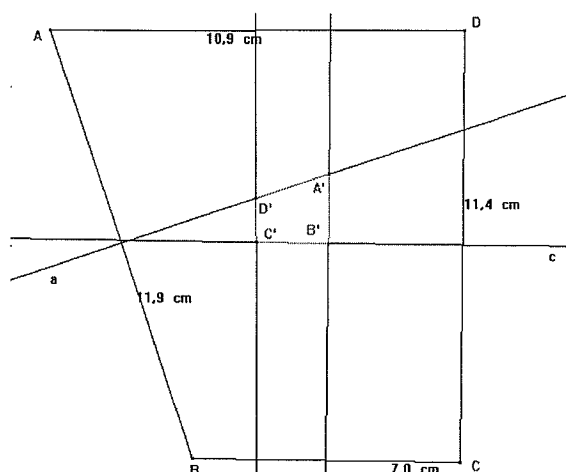

Figure 8.19. V&M&E, Ep.2, #68

- 67 Elisa: no, **I was thinking that ... just thinking!**  
 68 Elisa stops in Figure 8.19

- 69 Elisa: no, I mean ... **it degenerates into a point... it's logic**, isn't it?... if they are parallel ... I mean, if the sides are perpendicular... (drags B - Figure 8.20)...

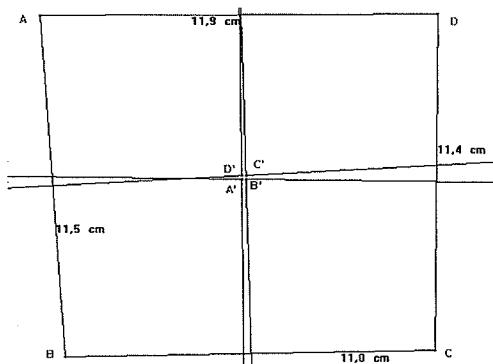

Figure 8.20. V&amp;M&amp;E, Ep.2, #69

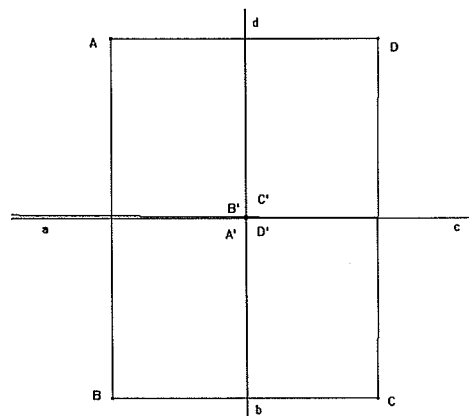

Figure 8.21. V&amp;M&amp;E, Ep.2, #71

- 70 Michela: I mean, we are looking for...  
 71 Elisa: I'm saying that if the opposite sides are parallel, those ones are perpendicular. Is that ok?... and if they are equal the midpoint is on the same line  
 72 Elisa drags C until ABCD is a rectangle (Figure 8.21)  
 73 Michela: ok... so?

## Extract 8.10. V&amp;M&amp;E, Ep.2, #66-73

Michela wants to start an ordered exploration of cases, beginning with a square (58). This is the first appearance of the situation with a point inside, even if the formulation of it happens only in 78 (see Extract 8.11, p.177). While doing wandering dragging (66) Elisa goes through the configuration with a point inside (Figure 8.18). Wandering dragging marks an ascending process (66-67), which quickly turns into a descending process (starting in 69), after dragging is stopped (68). Dragging is a disturbing element for Elisa when she is thinking, so that she suddenly stops in a configuration (Figure 8.19), which does not correspond to what she is thinking about. No conjecture is formulated, but a dynamic description of what she has seen on the screen is formulated in 69 (“it degenerates into a point”), which is the crystallisation of the process of dragging ABCD into a figure for which A'B'C'D' *degenerates* into a point. This is immediately followed by an explanation for it, which contains static conditional sentences (69, 71), that crystallise a relationship between the sides of the two quadrilaterals. Elisa does guided dragging (69) in order to get the figure she saw before (Figure 8.20 is very similar to Figure 8.18). This guided dragging leads to a ‘Cabri sketch’ rather than to a precise figure (the sides are not perpendicular). This is because there is a theoretical control over the figure<sup>24</sup> (there has already been a

<sup>24</sup> Compare this with Extract 8.5 of D&G (p.165), in which there is no theoretical control over the figure.

discussion about the properties of perpendicular bisectors in 60-63), which is now a support for proving and not a field of discovery. This is typical of a descending process. The same function is attributed to Figure 8.21, which is obtained via guided dragging again (72), in order to show what Elisa says in 71, within the same descending process, which concerns the proof for the conjecture 'if ABCD rectangle then A'B'C'D' is a point' even if it has not yet been formulated as such. This last figure provokes Michela to agree with what Elisa has done, while before Michela and Elisa did not seem to communicate very well, in that their internal contexts were focused on different things. Michela tried to understand what Elisa wanted to do (70), but 73 shows that Michela does not see the point of what Elisa has just said, even if she understands it.

The students leave the perpendicular bisectors visible and their conjectures are all about the sides of the two quadrilaterals, without referring explicitly to known quadrilaterals (they do not talk about rectangle or square, but about quadrilaterals with parallel sides). This way, their conjecturing is intertwined with proving and the two activities are really part of *one* process, i.e. the proving process. Justifications and explanations are mixed with conjectures, and sometimes conjectures are not even formulated, but emerge from discussions about properties in the configuration at stake (see for example 83 in Extract 8.11 below).

- 74 Elisa drags A, then D randomly, and then puts the figure back as it was before  
 75 Elisa: say something!  
 76 Elisa drags B, D, C, then D and A  
 77 Valentina: **what are you doing?** Moving it randomly?  
 78 Elisa: no, I was trying to see if I could make a figure...  
 79 Valentina: listen, let's think ... a moment ... since before we did ... just to finish that part, when it degenerates into a point the quadrilateral, which ... am I wrong or we haven't explained it yet ...  
 80 Michela: **so, she said:** since the properties of the perpendicular bisector are being at a right angle and the distance from a point ... if ... all the segments are parallel, then, since they are perpendicular ... Moreover if 2 of ... as for example in a square, the midpoint must be on the same line.  
 81 Valentina: ... yes  
 82 Elisa dragged the vertices of ABCD to obtain Figure 8.22.  
 83 Elisa: **I'm doing a parallelogram** ... the sides are parallel aren't they in a parallelogram? Therefore the perpendicular bisectors are parallel too, aren't they? They are parallel 2 by 2.  
 84 Valentina+  
 Michela: yes  
 85 Elisa: so also the segments of A'B'C'D' are parallel ...  
 86 Valentina: that is it keeps ... no, nothing ...  
 87 Elisa drags B, C, D to get a rectangle (Figure 8.23)  
 88 Elisa: so, we proved the square ... degenerates...  
 89 Valentina: so if ... when ... well, that's natural because when there are 2 ... the 2 sides of the external quadrilateral ... the 2 parallel sides 2 by 2, it's natural ... I mean, it should always be that the perpendicular bisectors are ...  
 90 Michela: Yes

- 91 Elisa: because they are parallel ... they are perpendicular to 2 parallel lines
- 92 Valentina: ... they are parallel...
- 93 Elisa: **let's try to move the point and see what changes slowly** (Elisa drags C a little and slowly). So now they are no longer parallel, so ... these 2 (pointing at d and b) they are no longer parallel ... well, it's logic ... and these 2 (a and c) not... This is what we've been saying till now.

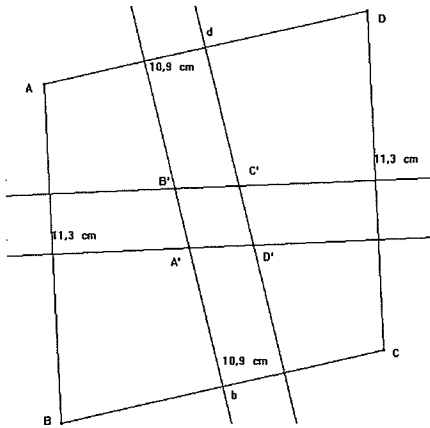

Figure 8.22. V&amp;M&amp;E, Ep.2, #82

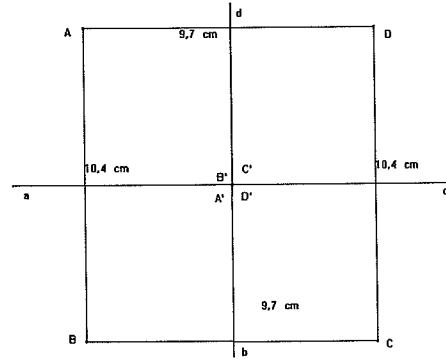

Figure 8.23. V&amp;M&amp;E, Ep.2, #87

## Extract 8.11. V&amp;M&amp;E, Ep.2, #74-93

This whole phase (74-93) is a descending process, which is led by Elisa. She starts with some wandering dragging. This dragging is interpreted differently by Elisa and Valentina. Valentina sees it as wandering dragging (77), while Elisa is doing it with a precise aim in mind (78). Elisa's interpretation of dragging shows that she is working within a descending process, in which the spatio-graphical field is a space for validation, in this case for validation of the explanation she gave in 71. In fact afterwards Elisa drags ABCD into a parallelogram, which confirms her explanation (83). On the contrary, Valentina interprets dragging in Cabri within an ascending process, in which figures are a field of discovery. Valentina is the one who brings the theory in first (60) and seems not to be much engaged with Cabri, so that she does not see the dragging in the same way as Elisa. She sees Cabri as a field of discovery but she does not see the usefulness of it at this particular moment. In fact, then she needs to stop what Elisa is doing and make explicit her need to understand (79)<sup>25</sup>.

This extract shows a process of synchronisation of the three students, who by the end are working on the same problem. Elisa is thinking and exploring with Cabri (emergent interaction), and at the beginning she does things with the mouse without making explicit what she is thinking (74, 76, 78). So we can see that Valentina does not follow what Elisa

wants to do (77) and does not understand the explanation of Elisa made in 71. Valentina needs to follow her own rhythm of thinking, which does not match Elisa's. At this point Michela acts as a 'synchronising agent', in that she successfully mediates between Elisa and Valentina (80-81). In the following part (83-93) the students now understand each other perfectly even if the language they use is not logical. It seems to be a 'language for adepts', which is shared by all the girls who are immersed in the situation. Figure 8.23 seems to have a key role in producing synchronisation, since it is after Elisa drags ABCD into that figure, that Valentina expresses her understanding of the situation (89). The explanation made by Valentina in 89 contains dynamic statements (when ... it should always be...). This is then 'translated' by Elisa into static statements, which crystallise the story into a proof statement (91).

The descending process concludes with a very slow<sup>26</sup> and controlled dragging (93), which has the function of dragging test for the conjecture and validation for the proof: after discovering that if sides are parallel then perpendicular bisectors are parallel (91), i.e. if P then Q, dragging is used in order to see that if  $\neg P$  then  $\neg Q$ <sup>27</sup>. Again the figure is a field for validation.

#### 8.4.2 *Lieu muet dragging* leading to a general conjecture

From 94 to 113 the students do some ordered exploration about what A'B'C'D' cannot become. The following extracts centre around the production of the conjecture and proof of the general conjecture about cyclic quadrilaterals, in which lieu muet dragging plays a crucial role.

- 113 Michela takes the mouse  
 Michela drags B and stops when the perpendicular bisectors meet at a point (Figure 8.24).

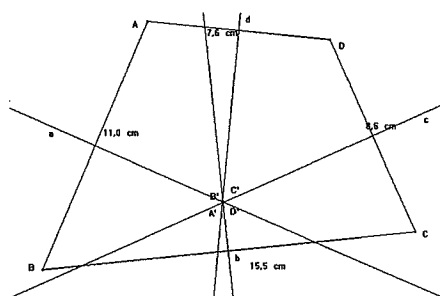

<sup>25</sup> For another example of different interpretations of dragging, see Extract 6.3 of B&T (p.120).

<sup>26</sup> The definition of 'slow' and 'fast' dragging concerns the speed at which the mouse is moved.

<sup>27</sup> This modality is what Boero et al. (1999) describe as "noticing a regularity B in a given situation, then identifying, by exploration performed through a *transformation* of the situation, a condition A, present in the original situation, such that B may fail to happen if A is not satisfied" (p.141).

Figure 8.24. V&amp;M&amp;E, Ep.3, #113

- 114 Valentina: so it can never be...  
 115 Elisa: **oh dear! It's a point again! ...**  
 116 Elisa: can I?  
 117 Elisa takes the mouse and drags C  
 118 Elisa: let's see what it is equal to, when it stays ...  
 119 Valentina+  
 Michela: when?  
 120 Elisa: I mean, **I'll try to move that stuff ..** and the point ... **keeping the point inside** ... I mean moving the point, but keeping that ... the quadrilateral is a point.  
 121 Michela: you mean to keep it inside ...  
 122 Elisa: ... to find a property that ... when it degenerates into a point, right?  
 123 Elisa drags B slowly trying to keep the perpendicular bisectors meeting at a point.  
 124 Elisa: let's mark the angles...(marks angle D)... but in a triangle the meeting point of the perpendicular bisectors is ...  
 125 Valentina: well, I thought about this before!  
 126 Elisa: centroid is the medians, orthocentre is the altitudes...  
 127 Valentina: then it's **the circumcentre**

## Extract 8.12. V&amp;M&amp;E, Ep.3, #113-127

Michela has the mouse and she is the one who decides what to focus on. And she chooses to get a configuration with a point inside (113) via wandering dragging that turns into guided dragging. Valentina is still thinking about what they were exploring before (114) while Elisa immediately 'reads' the figure on the screen (115), even if it is not her who produced it. The static description she makes ("it's a point again!" -115) focuses on the inside quadrilateral and marks a change in the way of looking at the two quadrilaterals. In the previous extracts the direction was from ABCD to A'B'C'D', in that the focus was on the effects on A'B'C'D' of some hypothesis on ABCD (parallel sides). Now, the focus is on A'B'C'D' (which is a point) and the aim is to find hypotheses on ABCD which have this as a consequence, as Elisa states in 122. Figure 8.24, which shows that in a 'strange' case (i.e. a quadrilateral which is not a regular one) there is a point inside<sup>28</sup>, is the starting point of the generation of the general conjecture (C4), which develops via lieu muet dragging. Elisa immediately wants the mouse back (116), showing the need for action when an idea comes to mind. The ownership of the mouse seems to be fundamental in these situations, in so far as it allows her to enter the Cabri space. She is working within an ascending process and states the strategy she wants to pursue (119, 120): she is fixing the thesis (A'B'C'D' point) and looking for properties of ABCD (122) for which A'B'C'D' degenerates into a point. This time she makes explicit her strategy first and then she drags, doing lieu muet dragging (123). The ascending process continues when she asks to mark the angles (124). But that very same sentence marks a turning point in the process: "but in a triangle the meeting

<sup>28</sup> For another example of a similar situation see Extract 6.3 of B&T (p.120).

point of the perpendicular bisectors is ..." (124) is an *abduction*<sup>29</sup>, which tells which rule this is the case of. A piece of theory, which is part of Elisa's internal context (as previous experience) is invoked in order to explain the current situation. The process then becomes descending. Lieu muet dragging provides the transformation of an ascending process into a descending process. By doing lieu muet dragging she observes what happens to the external quadrilateral ABCD while the internal one stays the same (a point) in order to discover some properties, so the process is ascending and the figure is a field of discovery. But then the theoretical field comes into play, because what is seen on ABCD needs to be related to the theory in order to be able to formulate a hypothesis, and eventually a conjecture. Therefore spatio-graphical and theoretical elements are linked together in the construction of the conjecture, through abduction. A descending process starts.

- From triangles they move onto quadrilaterals again. Elisa has the mouse
- 138 Valentina+
- Michela: **circumscribed**<sup>30</sup>!
- 139 Elisa: **circumscribed!** Maybe the circumscribed circle can be useful here too
- 140 Michela: try to draw the circle (in Figure 8.25)

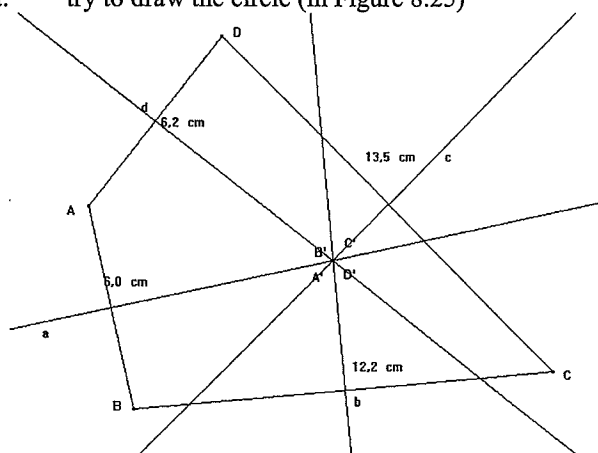

Figure 8.25. V&M&E, Ep.3, #140

- 141 Elisa: how?
- 142 Valentina: put one point on the other, C on D, so there is a triangle...
- 143 Michela: no, I'm saying ... also with the quadrilateral, isn't it?
- 144 Valentina: ah
- 145 Michela: maybe when it is a quadrilateral it can be inscribed in a circle...
- 146 Elisa: no, the centroid is the one outside, and the circumcentre is the one inside
- 147 Michela: circumscribed
- 148 Elisa: are you sure?
- 149 Michela: you mean when you can put a circle inside?
- 150 Elisa: **no, no, I got it!** It is the circumcentre ... it is not the one from the

<sup>29</sup> For a definition of abduction see chapter 2 (p.40) and Arzarello et al. (1998b).

<sup>30</sup> "Circumscribed" corresponds to the Italian word "circoscritto". The common English word for that would be "cyclic" but I decided to use "circumscribed" in order to stress the link the students make between the triangles and the quadrilaterals situation.

- inscribed circle, because it must be equidistant from the sides, mustn't it? (she points at the computer screen with fingers). This point (the intersection of the perpendicular bisectors) is the perpendicular bisector of this segment (AD) so it is equidistant from here and there (from A and from D).
- 151 Valentina: **wait**, stop for a second
- 152 Elisa: so this point here (points at the assumed circumcentre) ...if you have...look, a, which is the perpendicular bisector, is equidistant from the endpoints...
- 153 Valentina: sure!
- 154 Elisa: ...because the perpendicular bisector is the locus of a point equidistant from the endpoints... so it is equidistant from this one and from this one (Elisa points at the distances from the circumcentre to A and B). But from here (A), these two are equal... (She says this again, touching with her fingers one vertex, the centre and the other vertex, doing it for all sides) ...therefore at the end they are all equal and it is the radius, isn't it?...
- 155 Valentina+  
Michela: yes!
- 156 Elisa: ... I mean, I was not very clear
- 157 Valentina: then try to do the circle
- 158 Michela: **try to do it!** [...]
- 161 Elisa: wait, no! It's enough to look at ... The angles. How are the angles when ... when the quadrilateral is cyclic ... the opposite ... is it  $180^\circ$ ? I asked it ... Prof... when a quadrilateral is cyclic, the opposite angles... is the sum  $180^\circ$ ? [...]
- 167 Elisa: wait, now let's see. We move and we keep the point.
- 168 Elisa: then...82 and 98 yes...101 and 79 yes ... yes, ok... Anyway, **the proof is that** ... the perpendicular bisectors are equidistant from the vertices ... so this point (points at the intersection of the perpendicular bisectors) is equidistant from these 2 vertices (A and B), but also from these (A and D), and also from these (D and C) and also from these (C and B) ...isn't it?... so finally.... Isn't this situation similar to something we've already done?

Extract 8.13. V&M&E, Ep.3, #138-173

This phase continues with the descending process, which started in the previous extract (Extract 8.12). They all agree on the fact that something is circumscribed (138-139), making a link (analogy) between triangles and quadrilaterals.

Elisa suddenly understands the whole situation (150) and explains very fast her understanding (conjecture and explanation) in 150, 152, 154. There is a change in rhythm, which becomes very fast for Elisa and this provokes asynchrony. Elisa relates what she can see on the screen to her internal context and this triggers her understanding of the situation, which seems to 'explode' all of a sudden. For Valentina and Michela this is difficult to follow, as Valentina explicitly says (151). Elisa constructs a proof before even formulating the conjecture (which would be: if ABCD cyclic then A'B'C'D' is a point), she is working in the theoretical field, using the figure as a support for her reasoning, which is based on geometrical properties of perpendicular bisectors. All the statements used are a theoretical static description of the figure on the screen (ABCD), in the case when the thesis is fixed (A'B'C'D' is a point). The same proof is then stated logically in 173, after they have checked



---

that the conjecture is valid, via dragging test (173). This marks a reverse of the situation which now is again looked at directly 'from hypothesis to thesis': if ABCD cyclic then A'B'C'D' is a point.

In the last part (155-166) the students are synchronised, as we can see from the "yes!" in 155.

The main points of this analysis are:

- Lieu muet dragging is the key modality that leads to the generation of the general conjecture C4, starting from the particular case of the square C1. Different ways of focusing on the figures (internal or external quadrilateral) appear and are fundamental to allow the formulation of such a general conjecture. Guided dragging is used mainly within descending processes with the aim of checking conjectures, statements of proofs. The meta-comments students make about the use of dragging show a control over dragging, which is well managed and exploited towards the aim of the situation they are faced with.
- V&M&E prove while they are conjecturing and it is not possible to clearly distinguish conjectures and proofs<sup>31</sup>. All their conjectures contain reference to theoretical properties of perpendicular bisectors and show that these elements are clearly taken into consideration also while exploring and conjecturing.
- Transformations of objects and statements occur within the interaction between spatio-graphical and theoretical field and lead to the production of generic objects and conditional statements, within the whole proving process. In particular the shifts between ascending and descending processes are marked by a different way of looking at the two related figures (ABCD and A'B'C'D'), either looking for a hypothesis on ABCD such that A'B'C'D' has particular properties, or setting a hypothesis on A'B'C'D' and observing what ABCD becomes.

---

<sup>31</sup> The process V&M&E carry out, fits well with what Polya (1957) said, i.e. that deductive reasoning is crucial in the problem solving activity and exploration. Solving a problem means finding a connection between data and unknowns, and in order to do that one must use a "heuristic syllogism", that is a kind of reasoning which uses deduction together with inductive, statistical and circumstantial induction. Considering a heuristic conclusion as certain may be risky, but non consideration of such a conclusion at all may be an obstacle to progress. Therefore, in the process of solving a problem, a crucial point is a dialectic between the exploratory phase and the subsequent phase in which all the elements discovered informally are reorganised into validated statements.

## 8.5 THE STORY OF ALICE AND WILL<sup>32</sup> (A&W - CASE 5)

Alice and Will are A-level students from a Further Mathematics A-level course in Churchill School in Bristol<sup>33</sup>. They are high achievers with respect to mathematics. They used Cabri in two sessions before this one, in which they worked with constructions and macro-constructions and they were shown the use of the dragging test. The problem given to the students was: Angle bisectors of a quadrilateral (Figure 8.26). The session took place on the 27<sup>th</sup> September 1999.

Let ABCD be a quadrilateral. Consider the bisectors of its internal angles and the intersection points H, K, L, M of pairs of consecutive bisectors.

1. Drag ABCD, considering different configurations. What happens to the quadrilateral HKLM? What kind of figure does it become?
2. Can HKLM become any quadrilateral? Why?
3. Can HKLM become a point? Which hypothesis on ABCD do you need in order to have this situation?

Write down your conjectures and prove them.

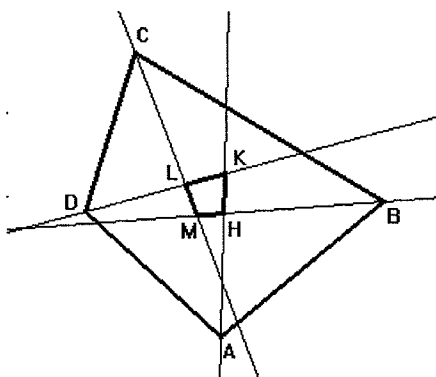

Figure 8.26. A&W. Angle bisectors of a quadrilateral

In this session they were asked to work on the problem presented above and then to present their conjectures and proofs to the whole class using an OHP. The session lasted 1 hour and 15 minutes (1 hour for the work in pairs at the computer and 15 minutes for the presentations).

The extracts presented below centre around the construction of conjectures C5 (if ABCD kite then HKLM point) and C2 (if ABCD parallelogram then HKLM parallelogram) and of proof P2 for C2. The analysis of the story of Alice and Will focuses in particular on the following issues:

<sup>32</sup> The proving process of Alice and Will is described in Appendix H (p.340).

<sup>33</sup> For a detailed description of the context of the setting see chapter 4 (section 4.2).

**Dragging modalities:** the use of dragging seems to be constrained by the particular construction the students made, which affects the possible transformations of the figure. Lieu muest dragging is key to discovering the general conjecture C5 (compare with V&M&E).

**Hiding/showing construction elements:** the students leave construction lines visible for a while and then hide them until the end of the process. This has an impact on both the conjecturing and proving phase (compare with V&M&E).

**Thinking/proof sketches:** the students use sketches while constructing the proof for C5. They are all thinking sketches and the way Alice in particular uses sketches is dynamic.

**Types of statements:** the construction of conjecture C5 and its proof show an interesting evolution of types of statements, from descriptions to dynamic and then static conjectures, through which particular objects are transformed into generic objects.

### 8.5.1 Showing and hiding construction lines: interactive feedback

The particular construction of the segments on the angle bisectors that Alice makes at the beginning of the proving process (Figure 8.27) does not let the students do 'free' explorations: as a matter of fact the short segments Alice constructs on the bisectors, which are then hidden, make the intersection points between the angle bisectors sometimes disappear, and with them the quadrilateral itself.

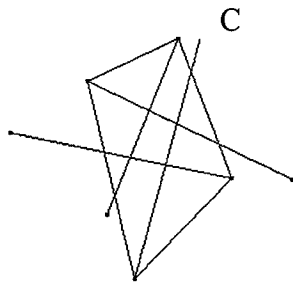

Figure 8.27. A&W, Ep.1, #5

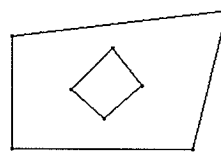

Figure 8.28. A&W, Ep.4, #99

- 15 Alice moves C up and sees that at some point one of the segments changes from inside the quadrilateral to the outside. Small movements around the position in which there is the switch and when there is a point. [...]
- 17 Alice goes to a point inside, but doesn't stop. Go to two vertexes to coincide. [...]
- 19 Alice: It can't when it's made outside
- 20 While saying this Alice makes a rapid movement to pass from the inside situation to the outside

Extract 8.14. A&W, Ep.2, #15-20

The starting point is wandering dragging of a segment, reasonably slow. But, something happens in 15, which makes Alice change her way of dragging. While dragging Alice sees

that there is a discontinuous switch between two segments, due to the particular construction they made, as explained above. Alice moves a vertex slowly around the 'surprising' positions (the point and the switch) and seems to be wondering what is going on. After this episode, her dragging is very much more controlled and does not use the whole space of the screen. It never happens again that one segment disappears, so this means that she is dragging in a very limited area.

- 99 Alice does undo, then constructs the four segments. Then hides the other segments (Figure 8.28)  
 100 As soon as she finishes Alice moves C  
 101 Alice: **oh wow!** That's really good! That's beautiful, isn't it!

Extract 8.15. A&W, Ep.4, #99-101

When the sides of the internal quadrilateral are defined (Figure 8.28), the new figure makes Alice change her way of dragging. There is in fact some wandering dragging quite fast.

### 8.5.2 *Lieu muet dragging leading to a general conjecture*

In the proving process of Alice and Will, there are a number of instances of lieu muet dragging. Most of them are related to the formulation of conjecture C5 (if ABCD kite then HKLM point), as shown in Extract 8.16 below. What follows can be looked at as one whole episode of lieu muet dragging that is split into different steps.

- 12 Alice: **oh it's a point now**  
 13 Will: if it's a square it will be a point [...]  
 69 Alice: If it's a square then they will definitely cross at a point. [...]  
 169 Alice: **which hypothesis on ABCD do you need in order to have this?** (they have Figure 8.29 on the screen)  
 170 Alice moves CD parallel to AB.  
 171 Will: it has to be...  
 172 Alice: If it's still a square ... oh no it's not a square ... it's a **rhombus**.  
 173 Alice moves CD up so as to have a point (Figure 8.30) then stops. [...]  
 174 Alice: surely it would work if opposite sides are equal because ...if opposite sides are equal.  
 175 Will: that's a rhombus now isn't it? And it is a point [...]  
 177 Alice: well any parallelogram will have opposite angles equal won't they so the bisectors would join on the same line [...]  
 185 Alice moves C along the diagonal AC Stops. Moves B to get a parallelogram and there is no point inside. Stops (Figure 8.31).  
 186 Alice: **yes. That's a parallelogram...**  
 187 Will: **that's not a point.**  
 188 Alice: oh no that's not...yes OK.  
 189 Will: so all sides ought to be equal.  
 190 Alice: yes all sides and ...So for HKLM to be a point...when is that? When it's two sides next to each other then must be equal. That should work.  
 191 Alice starts using the mouse on the still figure.  
 192 Alice: that's a triangle...  
 193 Alice moves AB down to get a point inside then stops  
 194 Alice: that is not a square yet.  
 195 Will: yes that's a rhombus. ...Pull that a bit (point C)  
 196 Will points at C and how he wants it to be moved.  
 197 Alice moves C along the diagonal slowly  
 198 Alice: yes that would change...**that'd be a kite**, yes. (looking at the measures

of the sides)

199 Alice moves C and she gets a point inside. Stops (Figure 8.32)

200 Alice: **that's a point isn't it? Wow!**

201 Alice goes to the point with the mouse.

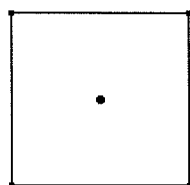

Figure 8.29. A&W, Ep.5, #148

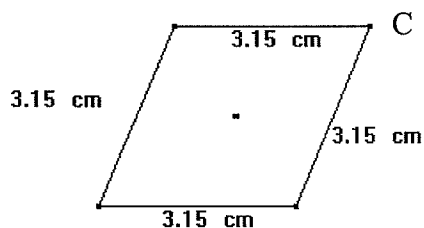

Figure 8.30. A&W, Ep.6, #173

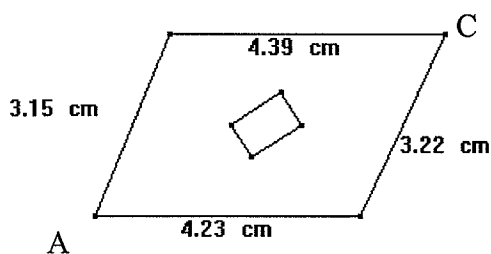

Figure 8.31. A&W, Ep.6, #185

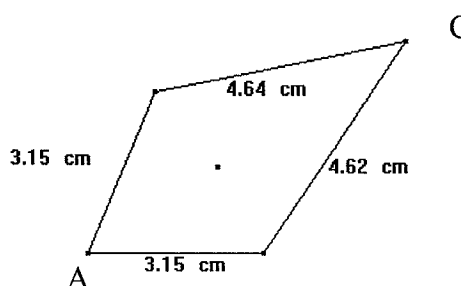

Figure 8.32. A&W, Ep.6, #199

Extract 8.16. A&W. Ep.7, #168-201

This extract shows the generation of conjecture C5 via lieu muet dragging<sup>34</sup>. It all starts with the formulation of a first conjecture (C1- If ABCD square then HKLM point) which is the formulation of something observed visually on the screen (12-13). While doing wandering dragging with ABCD, Alice goes through a configuration for which HKLM is a point and stops there because she finds it interesting. This is a typical move of exploring in a dynamic geometry environment: it is through dragging that things are seen and then a selection of interesting facts takes place and dragging is stopped<sup>35</sup>. At the beginning there is usually some wandering dragging which allows the observation of many configurations, even unconsciously. And particular cases are seen and then explored subsequently. One of the first things that are seen is the fact that sometimes HKLM becomes a point (and this happens in other transcripts as well – see D&G, V&M&E and B&T in this chapter). After

<sup>34</sup> Compare the use of lieu muet dragging in A&W with V&M&E (Extract 8.12, p.179) and B&T (Extract 6.2, p.120).

<sup>35</sup> This is what Boero et al. (1999) identify as “time section in a dynamic exploration” (p.140).

the formulation of this first conjecture, the same configuration is worked on again after some time in the process: the whole episode reported above can be seen as one unique instance of lieu muet dragging, which starts from a square (Figure 8.29) and ends up in a kite (Figure 8.32), transforming the conjecture ‘if ABCD square then HKLM point’ (C1) into ‘if ABCD kite then HKLM point’ (C5). The lieu muet dragging translates into action the search for a hypothesis on ABCD so that HKLM is a point (169). Looking for hypotheses means dragging so that the thesis is preserved. So Alice starts dragging CD with the intention of keeping a point inside (170-173). In this way she moves from a square (Figure 8.29) to a rhombus (Figure 8.30). At this point Will notices that it is a rhombus and it is a point inside (175). Alice tries to reason theoretically, and she ends up thinking that if ABCD is a parallelogram then there is a point inside (177). The next lieu muet dragging (185 - 199) is influenced by this new conjecture. In fact, the dragging from the rhombus in Figure 8.30 to the kite in Figure 8.32, goes through a parallelogram (Figure 8.31). Alice moves C along the imaginary diagonal AC, then stops and does guided dragging (185) to get a parallelogram, probably in order to validate her conjecture. But, as Will says, there is a parallelogram on the screen but there is no point inside (187). Dragging provides a counterexample. Therefore Alice moves AB down to get a point inside again (193), and the figure is a rhombus again (195). Then lieu muet dragging concerns point C, which is moved in the direction of the diagonal AC (197). While she is moving C, she looks at the point inside and tries to keep it. So a kite is finally generated (Figure 8.32).

The generation of the conjecture presented in Extract 8.16, shows that the key element of the discovery process is dragging along the (imaginary) diagonal AC, since the conjecture was generated from a square, to a rhombus and finally, by pulling a vertex in the direction of a diagonal in order to keep the point inside, to a kite. This influences the way these students construct a proof for this conjecture. In the proof the diagonal AC has a predominant role too, as they consider the kite divided into two triangles by its diagonal and prove the congruence of the triangles, as we see in Extract 8.17 below.

- 340 Alice wants to write the proof for the kite on paper, but before doing it she goes through it again on another paper figure discussing it with Will<sup>36</sup>.
- 341 Alice draws a kite on paper (fig2 in Figure 8.33)
- 342 Alice: are the bisectors the same at the end? [...]
- 344 Alice: can we just do that (DB) because then that angle is the same as that angle here (B and D) [...]
- 346 Will: just put a point there (between D and B and call it E) [...]
- 349 Alice: so, if you did the first in this way, then you need to use congruent triangles (AED & AEB), if we did the first bit with the perpendicular (DB)
- 350 Will: can we just say that if these are congruent triangles then for any points...no
- 351 Alice: oh yes, then EB would be equal to ED...or you can just use this one with that triangle there (AEB)..yes...the distance from any point along AC to B and D is the same. You've still got to prove that (indicates AC with a pen) that line goes... [...]
- 354 Will: shall we try to prove that ABC and ADC are congruent?
- 355 Alice: yes, try to prove that.
- 356 Will: any bisector of.. [...]
- 358 Will: for the bisector of angle D and B
- 359 Alice: Therefore the bisectors of
- 360 Will: of the angle D and B (Alice is writing down) [...]
- 363 Alice: right? so triangles ABC and ADC are congruent. And now...that makes sense...what..
- 364 Alice: yes, so bisectors....we need to draw the bisectors don't we? Just draw the bisectors
- 365 Will: these angles are equal too
- 366 Alice: yeah (fig 4 & 5 in Figure 8.33, draws diagonal) isosceles so the bisector is perpendicular and goes to the centre (draws)

<sup>36</sup> See this figure in order to follow the proof, given that the students did not put letters on the sketches (H=E).

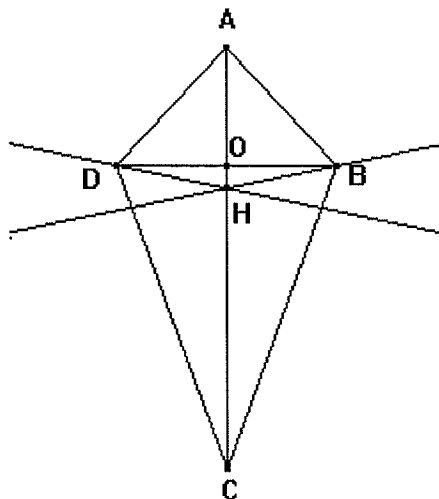

Alice  
27/9/99  
(groups)

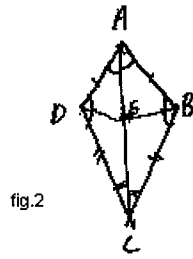

fig.2

Bisector of  $\widehat{DA}$  is the same as bisector  
= triangles  $\triangle ABC$  and  $\triangle ADC$  are  
congruent.

fig.3

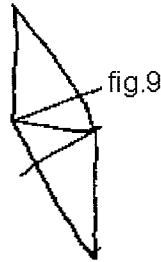

fig.9

fig.4

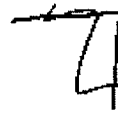

fig.5

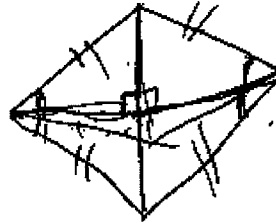
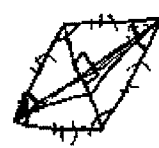

fig.7

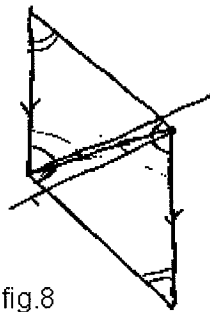

fig.8



fig.1



Figure 8.33. A&amp;W. Paper sketches.

Extract 8.17. A&W, Ep.9, #340-367

Alice and Will do not use paper while exploring and conjecturing with Cabri and they also write their conjectures on the screen, instead of using paper. However, when they decide to start proving their conjectures, they go to paper and do not use the Cabri figures on the screen any longer. Alice makes many sketches on paper while proving (Figure 8.33). The transcript shows that sketching is an integral part of the story of the construction of a proof



for the conjecture C5 (is ABCD kite then HKLM is a point). In fact Alice talks and constructs her proof orally while sketching. The whole episode is dynamic and it seems that sketches are *dynamic* too or are made dynamic. In a way, it feels as if Alice was dragging on paper, with the difference that she can manage well the sketches on paper, while she did not manage so well the Cabri figure. At this point of the process paper sketches better suit Alice's rhythm.

### 8.5.3 Types of statements in conjecturing and proving

This section focuses on the development of the conjecture about the parallelogram (C2), from the first instance in which the students considered the parallelogram configuration to the construction of a proof. In particular, the attention is focused on the evolution of the types of statements used and on the way the appearance of the figure (with construction lines – i.e. angle bisectors – visible) affected the proving process, both in the formulation of a conjecture and in the construction of a proof.

- 36 Alice: parallel...those two are parallel (two sides of the external quadrilateral in Figure 8.34) [...]
- 38 **Alice makes a kind of square/rhombus inside** (Figure 8.35).
- 39 Stops
- 40 Alice: I think it [the internal quadrilateral] can't be a square.
- 41 Silence. Alice points with the mouse at the square inside.
- 42 Will: can we draw a perfect square then?
- 43 Alice: the outside...
- 44 Will: can you draw...
- 45 Alice: **If those lines [two sides] are parallel then these are parallel** [two bisectors]

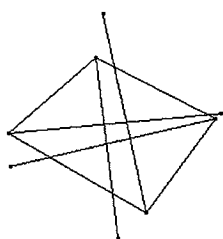

Figure 8.34. A&W, Ep.2, #36

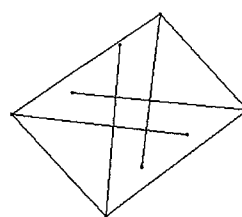

Figure 8.35. A&W, Ep.2, #38

#### Extract 8.18. A&W, Ep.2, #36-45

Extract 8.18 shows that at the beginning of the exploration of the parallelogram configuration, the students observe on Figure 8.35 the relationship between the parallelism of the sides of the two quadrilaterals (45). An evolution can be observed from 36 to 45 as far as the types of statements used: at the beginning Alice observes that some lines are parallel but without noticing any relation between the two quadrilaterals. Line 36 is a static description of what she can see on the screen. Then Alice moves the quadrilateral so that a

relationship emerges. In the last sentence (45) she puts into words the relationship between the outside and inside quadrilaterals in a static way, formulating a conjecture, which is still based on the observation of a fact.

- 110 Teacher: which objects are parallel?  
 111 Alice: those two  
 112 Alice indicates with the mouse on the screen.  
 113 Will: two pairs of lines in the middle of the quadrilateral  
 114 Will points at the square inside. [...]  
 118 Alice: **so that's a parallelogram now** [...]  
 120 Teacher: I was just thinking...this says about HKLM but what does it tell you about ABCD?  
 121 Alice: that it's...they are also [...]  
 123 Will: parallel  
 124 Alice: parallel  
 125 Teacher: that's my question really. We haven't got that information yet.  
 126 Alice: I'll just do it.  
 127 Alice makes it (ABCD) have a square inside (HKLM) and the check property tool says 'object are parallel' (Figure 8.36). [...]  
 131 Alice: **these two** are parallel...right OK.  
 132 Alice moves the side CD  
 133 Will: they are **always** parallel!  
 134 Alice: oh yes, they are always parallel!  
 135 Teacher: because you are moving a side now, that's OK.  
 136 Alice: yeah. **So any parallelogram**  
 137 Will: **so whenever the outside lines are parallel the inside ones are.**

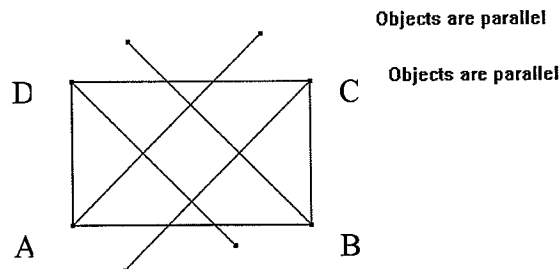

Figure 8.36. A&W, Ep.4, #127

Extract 8.19. A&W, Ep.4, #127-138

Extract 8.19 contains the generation of the conjecture. It is interesting to notice that the conjecture is not entirely formulated at the end. The focus is only on the sides of the quadrilaterals (sides of the external quadrilateral and angle bisectors that form the internal quadrilateral) but not on the figures as wholes. The key element which concludes this exploration (137- outside lines parallel means inside lines parallel) is the same element the proof is based on (see Extract 8.21, p.193).

The generation of the conjecture happens through lieu muet dragging, where the focus is to keep the perpendicular bisectors parallel, and the formulation in words of what happens while dragging. The students move from the description of a particular figure to a generalised statement. Lines 118 and 131 are descriptions of a particular status of the

internal figure (now). The statement “These two” refers to two particular lines of a particular figure. It is the static description of a property on the particular figure. From 132 onwards, Alice drags CD slowly and observes the consequences of the movement (film dragging). So the generation of the conjecture is physically dynamic, in that the conjecture is formulated while watching the figure moving. Dragging CD provokes a generalisation from the particular observation to a general statement saying the property is *always* true (133). Still there is no relationship expressed, but dragging makes the description dynamic and produces generality, which is underlined by the teacher's statement in 135. A justification in terms of dragging within Cabri is given by the teacher (135). In 136 a 'translation' of dragging into geometry occurs through language: dragging CD is *translated* into the geometric statement “any parallelogram”. Moreover this last figure is no longer referred to as a particular parallelogram (“this”), but it represents a generic object (“any parallelogram”). Line 136 is the beginning of the formulation of a relationship, which becomes general. The dynamic of seeing many parallelograms is transformed into the general statement “any parallelogram”. At the end (137) the conjecture is dynamic because time is in there (“whenever”) but general and it is formulated in a conditional form. The students have so validated their conjecture while constructing it.

143	Teacher:	have you got any conjecture written down?
144	Will:	no
145	Alice:	what are our conjectures?
146	Alice:	<b>when ABCD is a parallelogram HKLM is a parallelogram</b>

Extract 8.20. A&W, Ep.6, #143-146

Extract 8.20 shows the first time in which the students formulate the conjecture about the parallelogram, referring to the parallelogram as a figure. This happens when they are asked to write down their conjectures by the teacher. It seems that before being asked by the teacher, they did not feel the need of writing down the conjecture. The conjecture they write down (146) is presented in a static general form.

399	Alice:	right. Now let's deal with a parallelogram!
400	Alice decides to work on the parallelogram case while Will writes on OHP.	
401	Alice:	opposite angles are equal in parallelograms are they?... eh ... right [...]
403	Alice:	yes I'm trying to do the parallelogram. <b>If you know that...</b> they are the same angles right, because opposite angles are equal, those are bisectors ... [...]
405	Will:	Say that that angle...
406	Alice:	well you can say... <b>I know how you do it right? If you draw the diagonal there right?</b> (she draws it in Figure 8.37). Then you know that that angle there, the big one, is equal to that angle there (between the sides and diagonal)
407	Will:	Yes
408	Alice:	so that tiny bit equals that tiny bit.
409	Will:	because that's equal to that
410	Alice:	yeah. Therefore those alternate angles are equal therefore those two are

parallel [the bisectors].

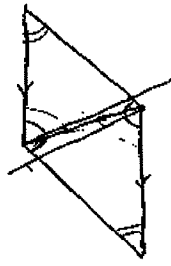

Figure 8.37. A&W, Ep.11, #404

Extract 8.21. A&W, Ep.11, #399-411

Alice and Will construct the proof. The present tense is always used in the construction of the proof. The spoken process of construction is the same that is then written up in the OHP (see Figure 8.38, p.194). However, this spoken proof contains some justification bits that are lost in the written proof, for example the fact that there are equal alternate angles that make the bisectors parallel (411). The key point is the construction of the diagonal of ABCD, which is not even mentioned in the written proof.

The two sentences in 403 (“If you know that”) and in 407 (“If you draw the diagonal there right?”) are dynamic conjectures, and have the function that Radford (1999) calls *generative action function*, even if in different ways. Line 403 is generative because it expresses something that if it is true than all the rest holds; it is the element starting the proof. Line 407 expresses a possible action, i.e. drawing a diagonal, which in fact reveals the key element for the proof. So it generates the proof itself. Therefore we can say that the proof is rooted in an action, and that very same element which generates the proof is kept in the writing of the proof and at the same time comes from the discovery process in Cabri (see Extract 8.18, p.190). There is a lot of descriptive language (this, that bit, etc) which refers to specific elements in the figure and is static, but at this stage the figure itself is looked at as a generic example. It is a support to carry on the reasoning (proof) but the specific elements of the drawing are not made reference to. In fact the figure on which the proof is constructed is a paper sketch.

The students were asked to write down their conjectures and proof on an OHP to be presented to the rest of the class at the end of the session. Figure 8.38 is what Alice and Will produced on an OHP.

WHEN ABCD IS A PARALLELOGRAM, SO  
IS HKLM.

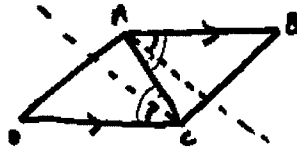

$AB \parallel CD \therefore$  red angles are equal  
 ---- are bisectors and  $\hat{A} = \hat{C}$  (opposite angles equal)  
 $\therefore$  black angles are equal  
 $\therefore$  green angles are equal  
 $\therefore$  bisectors are parallel  
 DO for other 2 bisectors  
 $\Rightarrow$  HKLM is a parallelogram.

Figure 8.38. A&W. Proof for C2 on OHP

This is the product these two students consider to be a proof to be presented to an audience (of other students who worked on the same problem). This is a proof because the statements are logically connected. It is interesting to notice that the language used does contain non-mathematical references, for example the angles are referred to with colours and not with their names. The picture does not contain the HKLM quadrilateral (only two bisectors are shown instead), but the conclusion we read is about HKLM. Even if this is supposed to be a proof to be presented to an audience that was not previously engaged with the whole proving process, not all premises and conclusions are made clear. Alice, while she is presenting the proof to the classroom, sees HKLM on that figure; probably she is recalling what she constructed before, but all this process is not made explicit to the audience. However she is satisfied with this proof: once she found an explanation for the conjecture, she is satisfied with that. The task of communicating the proof to the other students does not seem to be very relevant as far as the writing of the proof is concerned. The visual component is very strong. The need to make things clear in a visual way is much stronger than the need to refer to the elements of the figure with their names. Also there are no explanations for the logical connections.

In this written proof a verb referring to movement is present: "DO for other 2 bisectors". Then the conclusion is that "HKLM is a parallelogram". This "DO" seems to suggest the

presence of time still: the construction of the argument for one pair of bisectors is done, and then you have to do it for the other pair, i.e. an action has to be done after the first one. This proof is not completely a-timed. The tense use is the present, which in this case indicates that the things that are said are true, as they were proven to be so.

The main points of this analysis are:

- Lieu muet dragging is key to discovering the general conjecture C5, however it is used in quite a 'controlled' way and students move within regular quadrilaterals only.
- The sketches used by Alice while constructing the proof for the case of the kite are dynamic and are needed because they are more 'manageable' than a Cabri figure.
- Conjecturing and proving in the case of the parallelogram are based on the same element (the diagonal of the parallelogram).

## 8.6 THE STORY OF BARTOLOMEO AND TIZIANA (B&T - CASE 1)<sup>37</sup>

The analysis of the story of Bartolomeo and Tiziana focuses attention on the following issues:

**Dragging modalities:** even if not explicitly, lieu muet dragging is the modality which allows the discovery of the general conjecture C7.

**Emergent/planned interaction with Cabri:** there are episodes in which it is very clear what kind of interaction each student has, but, generally speaking, the actions in Cabri involve a constant emergent-planned move.

**Synchronous/asynchronous interaction between students:** it will be shown how the process of synchronisation happens on the Cabri figure after a phase of asynchrony and how long a phase of asynchrony can last.

### 8.6.1 Interacting *at* Cabri: synchronous and asynchronous interactions

Extracts 6.2 and 6.3 presented in chapter 6 (p.120) show how the process of synchronisation happens on the Cabri figure.

---

<sup>37</sup> For the context of the case of B&T see chapter 6 (section 6.2). This case is analysed again from the point of view of the framework which originated from it, because looking at the same transcript from the point of view of the framework highlighted more interesting issues to consider in the cross case analysis.

---

Tiziana drags ABCD to a rectangle (Figure 6.20, p.121), without saying anything. Bartolomeo does not follow Tiziana and does not appear to understand why she made a rectangle (70), but then he tries to work on what he is presented with, observing that “it is a point” (72). Tiziana does not communicate her ideas to Bartolomeo. Given that she has the mouse, she can do what she wants. Having the mouse allows her to control the situation autonomously. Bartolomeo follows her (70-83) until he needs to have the mouse himself (84) in order to get control again over the situation. In fact his strategy was that of checking all the particular cases, while Tiziana was more in an ascending process, being open to what Cabri shows her. However, even if they are working on the same figure and the same case (ABCD rectangle), this extract shows that Bartolomeo and Tiziana are observing the same figure, but what they 'see' is different. They are seeing the figure relating it to their two different internal contexts. And this is shown by the use of dragging and the types of statements produced. Bartolomeo sees that when Tiziana gets a rectangle then HKLM is a point. He wants to do a sort of dragging test (72) that seems to be a kind of test at a perceptual level (“make it bigger”). The aim is to check if it is still a point in another rectangle case. However Tiziana, who has the mouse, does what she wants, moving from Figure 6.20 to Figure 6.22 via Figure 6.21 (p.121). Tiziana expresses her reasoning, but Bartolomeo does not follow her. He is thinking about his conjecture. Bartolomeo formulates the conjecture for the rectangle (79). After this, Tiziana seems to abandon her line of thoughts and follows Bartolomeo; the two students now seem to have achieved synchronisation.

After having formulated the conjecture if ABCD rectangle then HKLM point (79), Tiziana sees a case in which there is a point inside but the external quadrilateral is not a rectangle. Bartolomeo does not pay attention to this (81), so the issue is abandoned. However at the end of the proving process, Tiziana goes back to that situation and leads the discovery of the general conjecture if ABCD cyclic then HKLM is a point, as we can see in Extract 8.22.

### **8.6.2 Interacting *at* and *with* Cabri: asynchronous interaction and shifts between emergent and planned interaction**

Extract 8.22 is an example of asynchronous interaction.

Bartolomeo<sup>38</sup>

Tiziana

364 Tiziana takes the mouse and goes to "circle". She tries to make a circle with the centre in the intersection of the perpendicular bisectors (Figure 8.39)

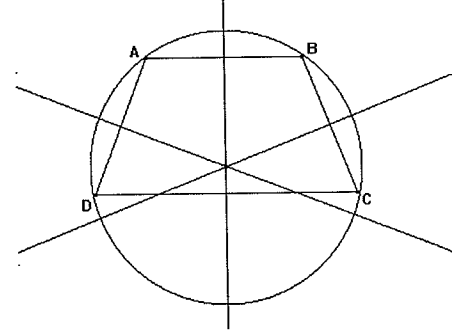

Figure 8.39. B&amp;T, Ep.8, #364

365 Tiziana: right!

366 Bartolomeo: I don't understand why you did that

367 Tiziana is about to draw another circle by mistake. Bartolomeo helps her to delete it. Then Tiziana drags B around by chance.

368 Bartolomeo: take out the circle... do this, take the circle out

369 Tiziana: no, wait, I did it wrong!... no, nothing, I wanted to do ...

370 Tiziana intersects the circle with all the sides of ABCD

371 Bartolomeo: I don't understand what you want to do!

372 Tiziana drags the circle to enlarge it, probably thinking that the quadrilateral is enlarged too, but the quadrilateral doesn't move

373 Tiziana: ok... ehm...

374 Bartolomeo: grab the circle!

375 Tiziana: no, wait...

376 Tiziana opens a new file, draws the quadrilateral again, then the perpendicular bisectors. Then she drags a vertex so that they coincide (Figure 8.40).

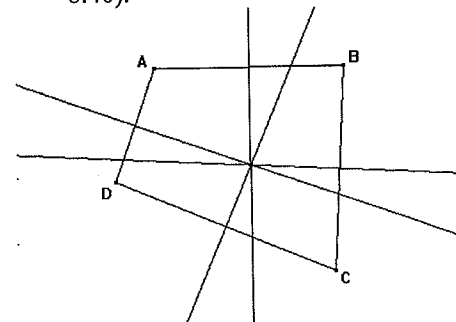

Figure 8.40. B&amp;T, Ep.8, #376

Extract 8.22. B&amp;T, Ep.8, #364-376

<sup>38</sup> This extract is presented in a form which shows the interactions between the students. The arrows keep track of ideas, how they develop and from whom.



---

The ownership of the mouse seems to play an important role in the interaction between the students, given the fact that there is only one mouse and it has to be shared somehow. Given that the main work is done in Cabri (these students do not use paper, apart from a few incidents in which Tiziana does some sketching – see section 6.4.3), the fact that a student can or cannot use the mouse provokes different kinds of interaction. This extract is an example of asynchronous interaction. Tiziana knows what she wants to do, but she does not seem to succeed in exploiting Cabri to her own means. However she keeps trying out things in Cabri, without explaining her ideas to Bartolomeo. He is making clear that he does not understand what she is doing (366 and 371), Tiziana does not pay attention to him. In 374 it seems that Bartolomeo begins to synchronise his thinking with Tiziana's thinking, as, instead of saying that he does not understand, he gives a suggestion (“grab the circle!”). In fact, just by watching what Tiziana does on the screen, he is able to understand (382-388) what she wants to get on the screen (a cyclic quadrilateral) and eventually will help her to do this (497).

The main points of this analysis are:

- There is not one specific episode of lieu muet dragging that leads to the general conjecture C7, but a very brief instance in which Tiziana does lieu muet dragging and discovers a configuration for which there is point inside but the external quadrilateral is not a rectangle (it is a case beyond C2). This becomes the starting point of the generation of C7 which continues much later on, towards the end of the proving process.
- In this episode the students leave the bisectors visible, even if they are exploring the figure (while they always hid them before during exploration and left them visible when proving, see section 6.4.2). This happens because now the students are in control of the situation and the figures have more the function of sketches. In fact, they are now working within a descending process in which figures are a space for validation or to try out theoretical ideas. Tiziana has an idea in mind (the fact that circumscribed quadrilaterals will probably have perpendicular bisectors which intersect at one point) and uses Cabri to check and validate it.
- The episode analysed shows that Tiziana's interaction with Cabri is emergent and planned alternatively. She seems to have an idea and starts doing something in Cabri. However while doing this it seems that she does not really know in advance what has to

be done and the feedback that the software provides is constantly re-interpreted by the students using Cabri.

## 8.7 SUMMARY

This chapter has presented some extracts from the stories of all case studies. The processes of construction and formulation of conjectures and proofs have been analysed according to the categories of the analytical framework presented in chapter 7. Table 8.7 presents a summary of the main issues which can be compared across cases. In the next chapter the stories presented here will be explicitly related to one another, in order to develop a model describing the proving process within a dynamic geometry environment and to address the main research questions.

	Issues for comparison	B&T	D&G	A&T	V&M&E	A&W
<b>C</b>	Construction lines visible (properties always evident)				Extract 8.10 (p.175) Extract 8.11 (p.177)	
	Construction lines hidden - 'forgetting' properties	Extract 6.7 (p.122)				
<b>DM</b>	Different interpretations of dragging	Extract 6.2 (p.120) Extract 6.3 (p.120)			Extract 8.11 (p.157)	
<b>DM</b>	Lieu muet dragging is 'controlled'					Extract 8.16 (p.186)
	Lieu muet dragging is 'free'	Extract 6.3 (p.120)			Extract 8.12 (p.179)	
<b>SC</b>	No 'theoretical' control over Cabri figures		Extract 8.1 (p.157) Extract 8.4 (p.164)	Extract 8.8 (p.170)		
	'Theoretical' control over Cabri figures				Extract 8.10 (p.175)	
<b>SS</b>	Need to have the mouse when an idea comes to mind	Extract 8.22 (p.197)	Extract 8.1157)		Extract 8.12 (p.179)	
<b>AD</b>	Proving is rooted in the SG field provided by Cabri		Extract 8.3 (p.162)			Extract 8.21 (p.193)
<b>AD</b>	How to manage the interplay between spatio-graphical and theoretical field?		Extract 8.5 (p.165)	Extract 8.9 (p.171)		

Table 8.7. Comparison of extracts

---

## CHAPTER 9. PROVING AS A FOCUSING PROCESS

*I didn't have to worry much about building the abstract model in my mind or draw it on paper, I just externalised the objects into the screen and started to create the circles, the tangents. By visualising the tangents and the sizes of the segments (whose relations kept invariant when modifying the figure), it was easy for me to understand (and prove for myself) that the other point of intersection was also orthogonal.*

*(Ernesto Laval, personal email communication, 1999)*

### 9.1 INTRODUCTION

This chapter will continue with the construction of a "model" (Miles & Huberman, 1994, p.91), drawing on the analysis of the stories discussed in chapter 8. This will lead to the development of an explanatory framework, which links all elements of the proving process. Drawing on the within-case analysis of chapter 8, I will discuss students' behaviour with respect to each of the categories, tackling the questions presented at the end of chapter 7. The stories are related to one another, so that a model describing the proving process within a dynamic geometry environment will emerge and answers to the main research questions will be provided. Figure 9.1 sets the chapter in the context of the overall analytical process as described in chapter 5 (section 5.7).

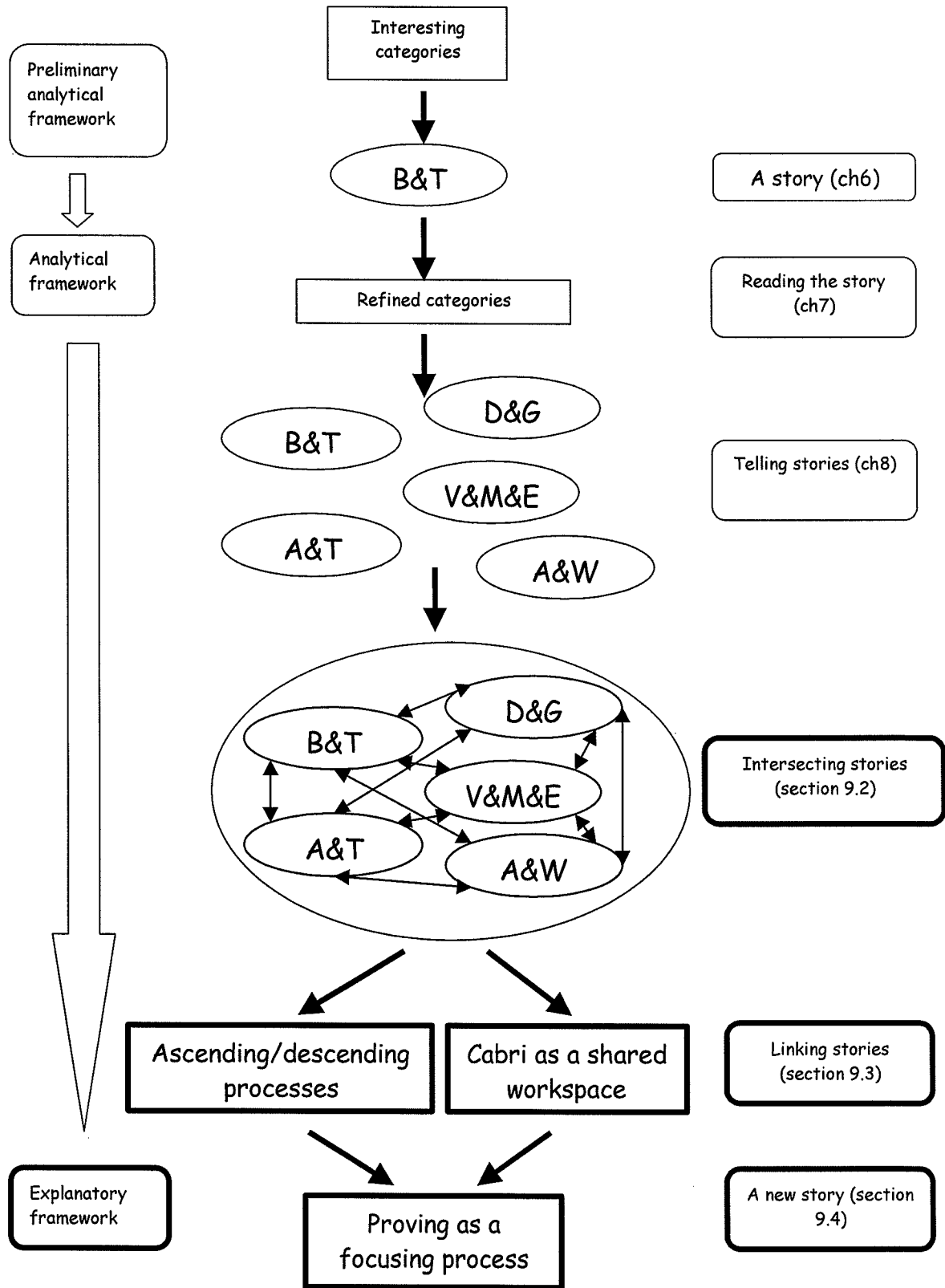

Figure 9.1. Developing an explanatory framework

The chapter is divided into three sections, as shown in Figure 9.1. The first section will draw conclusions for each element of the proving process, based on a cross case comparison. The second section will develop main global conclusions, linking all elements of the proving process. Finally, an explanatory framework related to proving as a *focusing process* will be presented.

## 9.2 DEVELOPING AN EXPLANATORY FRAMEWORK. INTERSECTING STORIES: WHAT IS THE SAME AND WHAT IS DIFFERENT?

This section draws out the main elements from the stories presented in chapter 8, related to each category of analysis. In each section some comparison of the category within all cases is presented in order to provide the reader with a sense of the whole. Reference to the extracts presented in chapter 8 provides the evidence for the assertions made here. Reference will be made also to other parts of the full transcripts, which were not analysed in the previous chapter (due to space limits), but were used in the process of developing an explanatory theory.

The categories of analysis are summarised in Figure 9.2, which shows the hierarchy and dependencies between them.

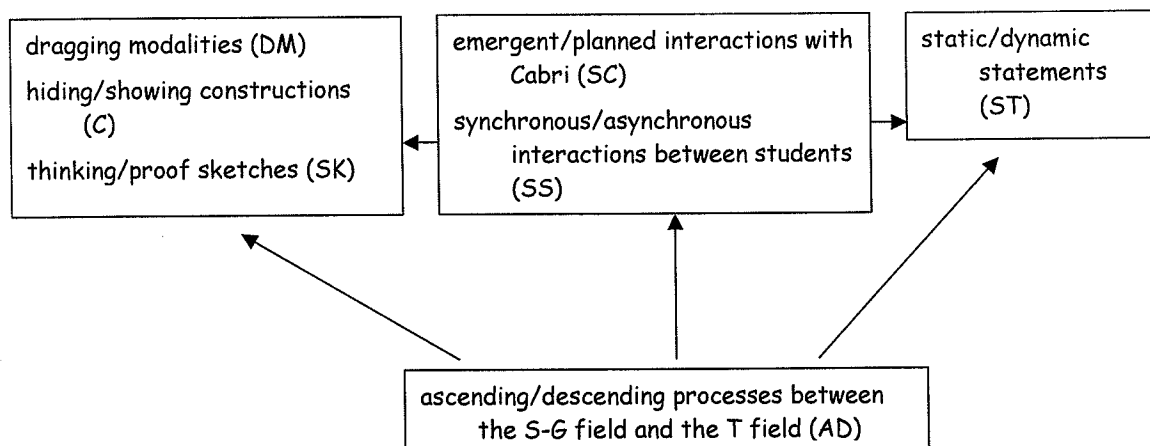

Figure 9.2. The analytical categories

### 9.2.1 Dragging modalities: which, when and why?

The main tool, which makes Cabri different from paper and pencil, is dragging. The analysis of the case studies has shown that students exploit the potentialities of dragging in different ways; they use different dragging modalities in different phases of the proving process and each modality is related to a particular aim.

Figure 9.3 shows an overall picture of which dragging modalities the students from each case study used during their proving process.

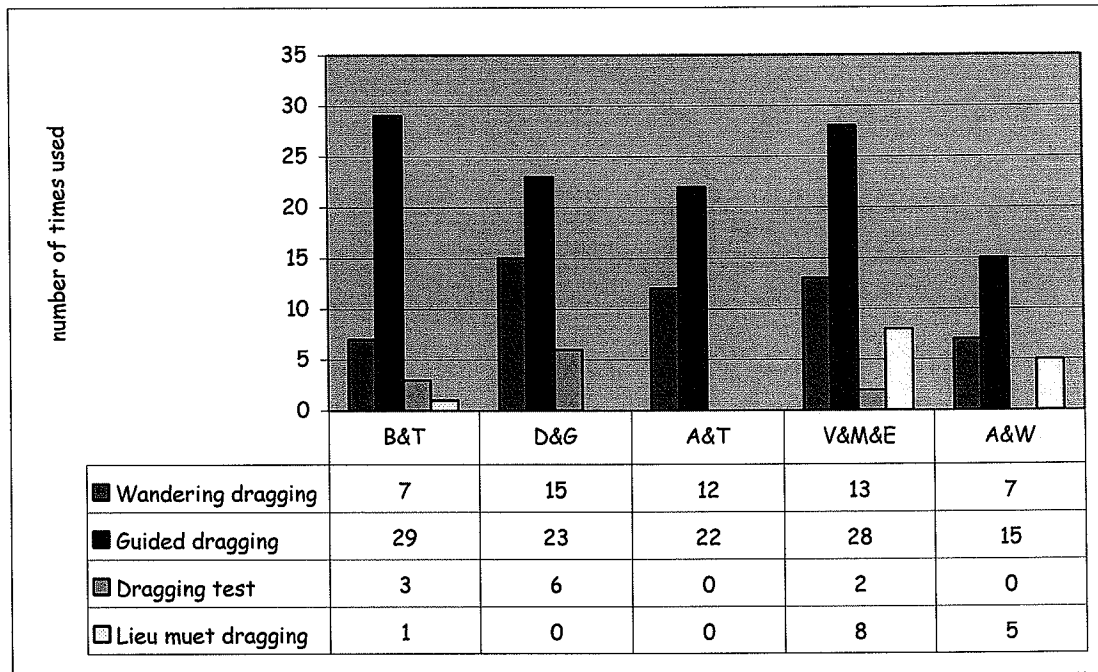

Figure 9.3. Cross case analysis: use of dragging modalities<sup>1</sup>

What emerges from an analysis of this data is that:

- all students carried out a considerable amount of guided dragging;
- only three pairs used lieu muet dragging and not many times in the process;
- different cases show a different range of modalities used.

Drawing on the fine analysis presented in the previous chapter, this section will explore these results in more depth.

All students made extensive use of **guided dragging**. However, this dragging modality is used differently across cases. A first difference concerns the kind of figures produced with guided dragging. Bartolomeo and Tiziana (case 1) use guided dragging in order to produce precise figures on the screen<sup>2</sup> (which are controlled for example by means of measuring sides and/or angles), while Alice and Will (case 5) use it mainly to produce ‘Cabri sketches’, i.e. figures which are only approximately exact (e.g. something that is ‘almost’ a

---

parallelogram or ‘almost’ a square). Debora and Giulia (case2), Alessandra and Tiziana (case 3) and Valentina, Michela and Elisa (case 4) produce both precise figures and Cabri sketches. The use of precise figures shows the need for a visual support to work with and to base the explorations on. This relates to the occurrence of ascending processes in which the figure works as a field of discovery. When students use approximate figures they show a theoretical control over the spatio-graphical support, which is used mainly as a support for students' reasoning but not as a figure to be ‘read’ in terms of discovery. This shows the occurrence of descending processes; moments in which students use approximate figures often contain justification elements besides conjectures. For example, Alice and Will show a theoretical control over guided dragging. The fact that a figure on the screen is a parallelogram or square or some other shape is controlled by the students thanks to the theoretical properties they associate to the figure, even if they are not so evident from the Cabri figure on the screen, which is not a precise parallelogram or square (see Extract 8.18, p.190). The same thing happens in the case of V&M&E (see Extract 8.10, p.175). Sometimes students obtain approximate figures with guided dragging, but without being aware that they are not precise figures and this is a cause of conflicts, as for example in the case of A&T (see Extract 8.8, p.170 and 8.9, p.171) and D&G (see Extract 8.4, p.164). In these situations intervention of the teacher is necessary in order to provoke the students to change the way they look at the figure: they need to understand that the figure they have on the screen is an *approximate* figure and therefore needs to be read as such. In the case of A&T, the teacher suggests they construct a figure with the required properties, so that the Cabri figure can then be manipulated as an object that has the properties they want it to have (it is a square). In the case of D&G, the students are able to change their point of view and look at the figure from a theoretical perspective, i.e. looking at it *as if* it was a parallelogram, without needing to construct a new one (see Extract 8.5, p.165).

A second difference regarding the use of guided dragging concerns the aim students want to pursue with it. On the one hand, guided dragging may be chosen as a starting point of the exploration. On the other hand, guided dragging allows students to focus on a particular figure (or particular case), which has somehow been discovered first by another kind of

---

<sup>1</sup> The number of times each dragging modality was used is shown in Figure 9.3. The number of times is the number of instances (which correspond to numbered lines in the transcript) in which a particular dragging modality was used, without taking into account the length of the dragging in that particular instance. Only the dragging modalities observed in the processes of the case studies are shown here.

<sup>2</sup> These figures are not constructed according to geometric properties.

dragging, e.g. wandering dragging (see Extract 8.10 from V&M&E, p.175) or by means of theoretical elements, e.g. thinking about properties of quadrilaterals (see Extract 6.1 from B&T, p. 119). An example of the first type of use of guided dragging is provided by Bartolomeo. His guided dragging showed a particular strategy, which was an ordered exploration of cases (see section 6.4.1, p.119): he uses guided dragging as a discovering tool within an ascending process, in which the figure is a field of discovery. The two processes are represented in Figure 9.4. Guided dragging therefore may serve different aims: it may be a source of discovery within an ascending process (when it is used to produce figures about which properties need to be discovered) or as a support for students' own thinking (when it is used to produce a figure corresponding to a specific idea, which came from somewhere else), within a descending process.

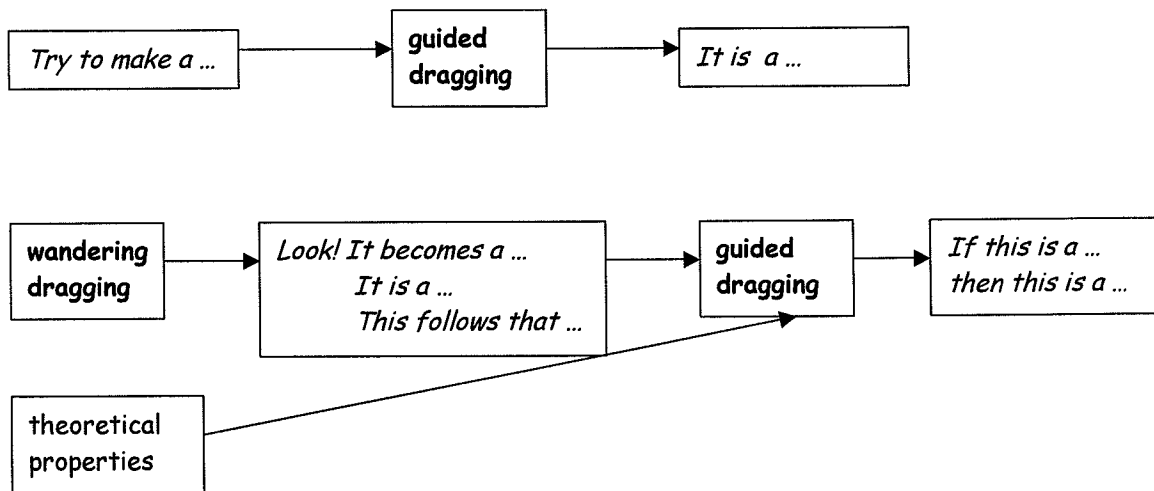

Figure 9.4. Cross case analysis: the use of guided dragging

**Wandering dragging** is mainly used as a discovering tool during the exploration phases in the proving process, usually at the very beginning, with the aim of obtaining ideas about the problem situation (see e.g. Extract 8.1 from D&G, p.157). It may be fast or slow. In the first case, wandering dragging may be a cause for asynchrony in the students' interaction (see 88-89 in Extract 8.1, p.157 as a paradigmatic example), because the person who does not have the mouse finds it difficult to enter into the situation if the figure moves too fast and he/she is not producing the movement (see also section 9.2.6).

Even if the prevalent dragging modality used is guided dragging for all students, the modality of **lieu muet dragging** was crucial for the discovery of the most general conjectures the students produced (see the cases of B&T, V&M& and A&W). Lieu muet dragging was the starting point for the generation of the very general conjecture C7 (If ABCD is cyclic then HKLM is a point) in the case B&T (see Extract 6.2, p.120) and in the



---

case of V&M&E (see Extract 8.12, p.179); and it was the means through which conjectures C5 (If ABCD kite, then HKLM point) and C7 (If there are two pairs of adjacent and equal length sides then HKLM is concurrent - kites, squares, rhombi) were generated by A&W merging particular cases (see Extract 8.16, p.186). Lieu muet dragging seems to be the key element to *generate generality* at different levels, in that different students produced different general conjectures, according to what they started lieu muet dragging from. The lieu muet dragging A&W are using is more 'controlled' than the one used by V&M&E and by B&T. This is because they start from a precise figure for which there is a point inside (a square) and they move within regular quadrilaterals (rhombus and kite). On the contrary B&T and V&M&E start from a 'strange' case (i.e. a 'not regular' quadrilateral) and then they do not go through regular quadrilaterals but see more general quadrilaterals keeping the point inside (see Figure 8.24, p.178). The fact that A&W control their dragging more may be rooted in what happened at the beginning of their proving process (see Extract 8.14, p.184), showing that the way the figure in Cabri is constructed may affect the solution process: different constructions produce figures with different behaviours with respect to dragging, and therefore constrain the possibilities of dragging the figure. The most general conjecture in the case of B&T is discovered thanks to the fact that Tiziana did 'free' explorations and happened to see a case in which the perpendicular bisectors coincided and the external quadrilateral was not a regular one (see Extract 8.22, p.197). The same thing happened with V&M&E (see Extract 8.12, p.179).

For all students dragging stops when the focus becomes one of constructing proofs. Either paper sketches or static Cabri figures are used as a support in the proving phase<sup>3</sup>. The need for a static figure to work on seems to appear at that point. This may be because they have already put in focus what they need and have formulated a conjecture. At this point, some students seem to prefer using paper sketches (this is the case for A&T and A&W) while others seem to prefer to work on the static Cabri figure, adding and deleting elements (this is the case for B&T, D&G and V&M&E). In the case of V&M&E, where conjecturing and proving are strictly interrelated as part of one whole process, dragging and not dragging constantly alternate; for example they use dragging to create counterexamples or to validate statements throughout all phases of the process (see Extract 8.11, p.177).

---

<sup>3</sup> In this case the term 'proving phase' refers to when students explicitly say that they want to prove something.

Besides dragging modalities, the way students interpret dragging was analysed in the case studies. The modalities of film-dragging and photo-dragging may be a sign of the occurrence of ascending and descending processes, as shown in Table 9.1.

	<b>Film-dragging</b>	<b>Photo-dragging</b>
<b>Ascending processes</b>	Exploration via wandering dragging Discovering invariants or regularities Producing a conjecture via lieu muet dragging	Ordered exploration of cases via guided dragging
<b>Descending processes</b>	Validating a conjecture via dragging test	Producing a figure which has been discovered in some other ways, in order to study that specific case

Table 9.1. Film/photo dragging and ascending/descending processes

To conclude, this analysis has shown that different dragging modalities *afford* different things and are used to pursue different aims in different cases. All modalities are important and in the case where all of them are used at appropriate times in the proving process (the case of V&M&E) we see a successful construction of conjectures and proofs. Moreover, lieu muet dragging was shown to be the trigger for the development of general conjectures.

### 9.2.2 Hiding or showing construction elements: a change in focus

Once a figure is constructed, Cabri allows the construction elements to be hidden<sup>4</sup> and shown again. Different behaviours with respect to using this possibility were observed, as illustrated in Table 9.2.

	<b>Case 1. B&amp;T- Perp. bis.</b>	<b>Case 2. D&amp;G- Perp. bis.</b>	<b>Case 3. A&amp;T- Varignon</b>	<b>Case 4. V&amp;M&amp;E- Perp. bis.</b>	<b>Case 5. A&amp;W- Angle bis.</b>
<b>Showing constructions</b>	when proving	always	N.A. <sup>5</sup>	always	at the beginning
<b>Hiding constructions</b>	when exploring		N.A.		after some time

Table 9.2. Cross case analysis: the use of construction elements

From this analysis, three clearly different ways of working with construction lines appear<sup>6</sup>:

- hiding construction lines from some point of the conjecturing onwards;

<sup>4</sup> In paper and pencil the possibility does not exist, because once drawn the construction lines remain visible all the time.

<sup>5</sup> Alessandra and Tiziana dealt with Varignon's problem, in which there are no starting visible construction lines (the key construction elements are the midpoints of the sides of the initial quadrilateral).

<sup>6</sup> This list is not meant to be exhaustive. There may be other ways of working with construction lines in Cabri, which were not observed in this research.

- 
- hiding construction lines when exploring and showing lines when proving;
  - showing construction lines all the time.

Bartolomeo and Tiziana hide the construction lines (i.e. the perpendicular bisectors) straight after finishing the construction, leaving only the two quadrilaterals ABCD and HKLM visible. Throughout their proving process, the construction lines are kept hidden when exploring and are made visible when proving, as discussed in section 6.4.2 (see Extracts 6.4, 6.5 and 6.6, p.121-122). This way of working contrasts with the case of Alice and Will. They leave the angle bisectors visible for a certain time after the beginning of the exploration process and then at a certain point hide them, without making them visible again (see Extracts 8.14 and 8.15, p.184-185). Debora and Giulia and Valentina, Michela and Elisa leave construction lines visible throughout the whole process. These three behaviours have different effects on the proving process. The conjectures formulated by Bartolomeo and Tiziana involve ABCD and HKLM as quadrilaterals (for example: "If ABCD is a parallelogram then this is a parallelogram too"). The conjectures and corresponding figures are then transformed for the proof, by stating the property which will be proven (for example: "so ... we must prove that those two [perpendicular bisectors] are parallel") and by restoring the construction lines. The conjecturing phase and the proving phase are separate. In the same way, leaving the angle bisectors visible allows the students A&W, D&G and V&M&E to keep the whole configuration (the two quadrilaterals and the perpendicular bisectors) in sight and to see the links between ABCD and HKLM, not only globally, i.e. in terms of figures as wholes, but also, and particularly, locally, i.e. in terms of properties of specific elements of the figure (e.g. sides or angles). For example, the first conjecture Alice and Will formulate is about the relationship between two pairs of opposite sides ("so whenever the outside lines are parallel the inside ones are" – see Extract 8.19, p.191). The fact that the parallelism of the sides of ABCD implies the parallelism of the sides of HKLM is what is then proven later on (see Extract 8.21, p.193). Only later in the process, when only the internal quadrilateral is visible, Alice reformulates the same conjecture in terms of parallelograms, i.e. in terms of global figures ("When ABCD is a parallelogram HKLM is a parallelogram" – see Extract 8.20, p.192). In the same way Valentina, Michela and Elisa always talk about perpendicular bisectors when formulating conjectures and they produce justifications and conjectures at the same time (see Extracts 8.10, p.175 and 8.11, p.177). Also the transcript of Debora and Giulia contains a long part in which they discuss what perpendicular bisectors are, since they can see them on the screen and they can see a relationship between elements of the figure divided by the

perpendicular bisectors, but they are not sure about the properties of perpendicular bisectors. Showing construction lines does not mean that the students would recognise the properties that characterise these lines, but makes them more aware of the way the two quadrilaterals are linked.

These behaviours with respect to hiding/showing construction lines seem to be linked to the need for focusing on different things in different phases of the proving process. If the construction elements are hidden then the exploration takes place at a more perceptual-visual level, because what is seen on the screen is just two quadrilaterals that are related while dragging (see Extract 6.10 from B&T, p.128) and some regularity is discovered through dragging. However the theoretical-geometrical elements (and consequently properties) that explain why such a relation holds are hidden and not available to students on the screen (see for example Figure 9.5).

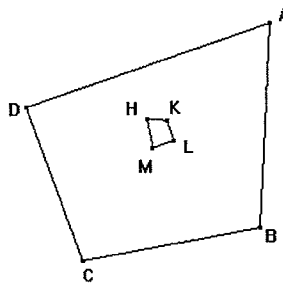

Figure 9.5

They need to be brought back again by the students. And this is what happens for Bartolomeo and Tiziana: when they start to prove they make the perpendicular bisectors visible again. It seems they are aware that they need them for the proof. Such a situation is completely different from paper and pencil. In paper and pencil the construction lines normally remain visible all the time<sup>7</sup>, so this means that the theoretical-geometrical properties are visible to students all the time.

When the construction lines are not hidden in Cabri, it is more likely that the exploration already contains some bits of justification, as shown in the case of A&W and V&M&E. For example the conjecture already contains the key element for the proof (e.g. parallel lines). The exploration in this case takes place at another level and it seems that the students are more conscious of what is going on and control the figure from a theoretical point of view.

<sup>7</sup> Unless you rub them off.

---

The link between the two quadrilaterals is explicitly visible. This does not mean that all students see this link automatically. For example, for Debora and Giulia, the fact of having the perpendicular bisectors visible has a negative effect: once they stop dragging, the students are not able to distinguish parameters and variables, and consequently hypothesis and thesis. All lines seem to have the same status, so that what they ‘see’ on the screen is a figure split into many small quadrilaterals by the perpendicular bisectors rather than two quadrilaterals linked through the perpendicular bisectors (see Extract 8.3, p.162). Hölzl (2001) deals with similar issues and suggests that we need to find ways

to help students focus on invariants rather than focus on details which suppress the overall impression of a drawing in its concentration on local relationships between parts of a figure. (p.84)

As other research has shown (e.g. Mariotti, 1996) constructing geometric figures in Cabri fosters theoretical thinking. In fact, in order to construct a figure in Cabri, the geometric properties of that figure are needed for the construction itself. If a figure is drawn in Cabri in the same way as on paper (i.e. reproducing a mental image associated with a particular name, which however does not necessarily contain its properties - e.g. a square is something that looks like Figure 9.6, but while drawing it on paper the properties of having equal sides and right angles are not necessarily evoked), then that figure does not pass the dragging test, i.e. it will be messed up when dragging it.

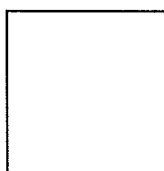

Figure 9.6. Image of a square

However, the situation is different when some constructions are required on a general quadrilateral, as for example in the open problems used in this study (e.g. constructing the quadrilateral formed by the intersection of the perpendicular bisectors of a given quadrilateral). In Cabri, the fact that there is a menu command that constructs the perpendicular bisector of a segment, allows the students to use it without thinking about the property of the perpendicular bisector with respect to the segment. The only thing to do is to find and use the command. On the contrary, if they were constructing perpendicular bisectors with pencil and paper they would need to think how to draw them, i.e. they would need to know that they are perpendicular to the side and go through its midpoint. Therefore in Cabri the geometric properties are not needed at the beginning and probably are not evoked. This would explain why some students seem not to pay attention to the properties

of the construction (e.g. the fact that perpendicular bisectors are perpendicular to a side) while proving (see Extract 6.7, p.122). Goldenberg & Cuoco (1998) noticed a similar thing:

in DG environments the drawings on the screen are transformed continuously, giving the impression that the user is checking an infinite number of cases on the way to the new selection. The selector's function output is an object (triangle), on which some construction is performed; the input is a feature of the object (vertex) and the method for obtaining the output is to move it to another part of the plane. Once the construction is completed the object can only be 'deformed' by dragging its elements, but the construction is almost forgotten: the object is seen as one singular thing (p.359).

The main conclusions we can draw from this analysis is that the possibility of hiding and showing construction lines makes the situation of working in Cabri completely different from dealing with the same problem with paper and pencil. What you see on the screen influences the construction of conjectures and proofs and choosing what you want to see on the screen influences the proving process some way rather than another way. In Cabri pupils are in control of what is on the screen in an interactive way and they can adjust the situation by hiding and showing elements to deal with new discoveries or ideas.

### 9.2.3 Thinking sketches and proof sketches: searching for an alternative space to Cabri

In all case studies, the students were asked to work with Cabri but they were also told to feel free to use other tools, as for example paper and pencil. Students used paper in different ways (Table 9.3), in different phases of the proving process and with different levels of integration of it within the Cabri work.

	<b>Case 1. B&amp;T- Perp. bis.</b>	<b>Case 2. D&amp;G- Perp. bis.</b>	<b>Case 3. A&amp;T- Varignon</b>	<b>Case 4. V&amp;M&amp;E- Perp. bis.</b>	<b>Case 5. A&amp;W- Angle bis.</b>
<b>Paper sketching</b>	yes – when conjecturing	yes – when bringing in the theory	yes – when proving	no	yes – when proving

Table 9.3. Cross case analysis: the use of sketches

Alessandra and Tiziana draw on paper when proving, and actually their figures are not proper sketches, in that they are instead very precise figures, obtained by measuring sides with a ruler (see Extract 8.7, p.169). Alice generates a series of sketches on paper while attempting to prove two conjectures (see sketches in Extract 8.17, p.189), so the process of sketching on paper is dynamic and seems to indicate the need of better focusing on something which is not yet very clear.

Diagrams have been used in many periods of mathematical development, but the static diagram has a number of draw-backs. A diagram usually develops over time, and the author's clarity is achieved through that sequential growth. However, when completed, derivation and sequence dynamic is lost.

---

The diagram is a particular picture, but can't directly express in what way it is particular. (Mason & Heal, 1995, p.301)

Alice seems to transform a static paper drawing into a dynamic drawing, which tells a story. The choice of paper is due to the fact that Cabri was not seen as an appropriate tool at a moment in which the spatio-graphical field had to be a support for students' thinking. Sketching was more suitable to students' rhythms at this point (see also section 9.2.5). That is the only case in which sketches seem to be 'dragged' on paper. In all other cases sketches are static and appear to be a substitute for Cabri. At the beginning of the process, Giulia makes a sketch on paper (see Extract 8.2, p.160) after they had been exploring the relationships between the two quadrilaterals without success, and after having suggested to Debora a couple of times what she wanted her to do on the screen. Therefore this sketch may give Giulia the possibility of 'touching' the figure herself and is a way of stopping the exploration process and seeing if something can be put into focus. The other two sketches that Debora and Giulia make, are used to make explicit a geometrical property they want to use in the situation they are exploring (see Extract 8.3, p.162). In this case Cabri does not work as a space for exploration and communication: when the situation is clear and the students have a property in mind, they choose the means which is faster to draw what they want, i.e. paper in this case. The paper sketches Bartolomeo and Tiziana do are static and again are an indication of wanting to stop the proving process once some elements are put in focus (see Extracts 6.8 and 6.9 - Figure 6.24 & 6.26, p.123-124). The sketches are then a way of working on a particular configuration or represent a proof themselves, being a 'summary' of the 'story' of the conjecturing and proving until that point.

The analysis has shown that paper sketches may represent an alternative to the Cabri workspace in different ways: for example when students want to prove or when they do not have the mouse but want to do some experiments themselves. A sketch is under students' control: it can be constructed at the same time as they talk. Sketches on paper can be constructed by adding elements in an order other than the construction order that you need to follow in Cabri in order to get a figure which does not 'mess up'. On paper different lines can be added according to the students' thinking flow, as happens with A&W. When students formulate a general conjecture, the Cabri figure changes status: it comes to represent a "generic example" (Balacheff, 1999). So students usually stop moving in Cabri and leave the figure representing their conjecture on the screen. Then it may happen that they go to paper. The reason why is that maybe at this point it is important for the students

to draw a figure themselves, as the Cabri figure is implicitly constrained by the construction, so that they cannot 'build' their own conjecture in it<sup>8</sup>. Once the figure is constructed in Cabri, it can be modified by dragging, but not in the internal geometric relationship between elements. The final figure representing the conjecture is a result of the variation of the initial constructed figure, by moving only a fixed number of points (the free ones). But it cannot be completely controlled and modified by the user according to his/her intention. The figure on paper, instead, is constructed according to some particular hypotheses set by the user. In the proving phase, the students need to assign a meaning to a figure and this is not something that comes naturally in Cabri. In Cabri they would need to reconstruct the figure according to its geometric properties, which is quite a long process and is not necessary at this point, because it does not give anything more at this stage. Moreover, the rules according to which a Cabri figure changes under dragging are not explicit to students, so that even if they know how Cabri figures work, at some point they might need to work with a figure they completely 'own', know and manage. For example, Alice and Will would have needed to construct a parallelogram in Cabri in order to do all the explorations they carry out with paper sketches, and constructing a figure in Cabri would have required time and effort the students did not believe useful at that point<sup>9</sup>.

#### 9.2.4 Static and dynamic statements<sup>10</sup>: focusing on relationships

Together with the transformations that figures undergo via dragging in Cabri and sketching on paper (as discussed in sections 9.2.1, 9.2.2 and 9.2.3), also the statements produced around these objects are transformed throughout the proving process<sup>11</sup>.

What emerges from the transcripts is that the same conjecture is formulated different times in the process and the statements change and evolve from (static or dynamic) descriptions to conditional statements, i.e. (static or dynamic) conjectures. So the proving process is not

---

<sup>8</sup> "Tall (this volume) notes that computer images provide greater precision and control than hand-sketching. This is certainly true; however, if the visual stimulus is being used as an aid to mental processes then the precision of the objects may interfere with the mental images" (Scrivener, 1995, p.316).

<sup>9</sup> "Of great importance in this latter respect is the speed and lack of effort with which meaningful sketch marks can be produced. [...] The act of sketching requires little preparation. [...] There is a limited interference between the act of sketching and the visual-imaging processes of creation, retention, manipulation, comparison and evaluation" (Scrivener, 1995, p.317).

<sup>10</sup> Even if considered one of the key points of the proving process, the use of language in the production of statements within the proving process was not studied in detail for all case studies. This was due to lack of analytical tools which would have been needed in order to deal with the use of language in such a large amount of data. Therefore this section will draw provisional conclusions based mainly on theoretical explanations and on the evidence provided by the analysis of a small part of the data (see section 6.4.4, section 8.2.1, and section 8.5.3) .

<sup>11</sup> See Table 7.5 p.145 for the description of this category.



linear, but the same configurations are tackled at different stages of the process (as illustrated by the tables in Appendix E, p.318, Appendix F, p.329, Appendix G, p.339 and Appendix H, p.350).

The results from the analysis of the transcripts relate to what Jones (2000) reports as regarding a study with younger students (12-13 year old) working with the classification of quadrilaterals with Cabri. He found that the students' formulations of conjectures and explanations for the presented tasks changed from purely descriptive statements relying on perception to more precise explanations, at first situated in a dynamic environment and then related to the mathematical context.

Extract 8.1 (p.157) contained dynamic descriptions which were transformed into dynamic conjectures embedded in the Cabri environment (D&G). Extract 8.19 (p.191) has shown the generation of a conjecture (131-137) through the transformation of a static description into a dynamic then static conjecture (A&W). Table 6.4 (p.125) has shown the transformation of statements for two conjectures in the case of B&T. Figure 9.7 and Figure 9.8 represent two typical processes which can be observed throughout the proving processes in the case studies.

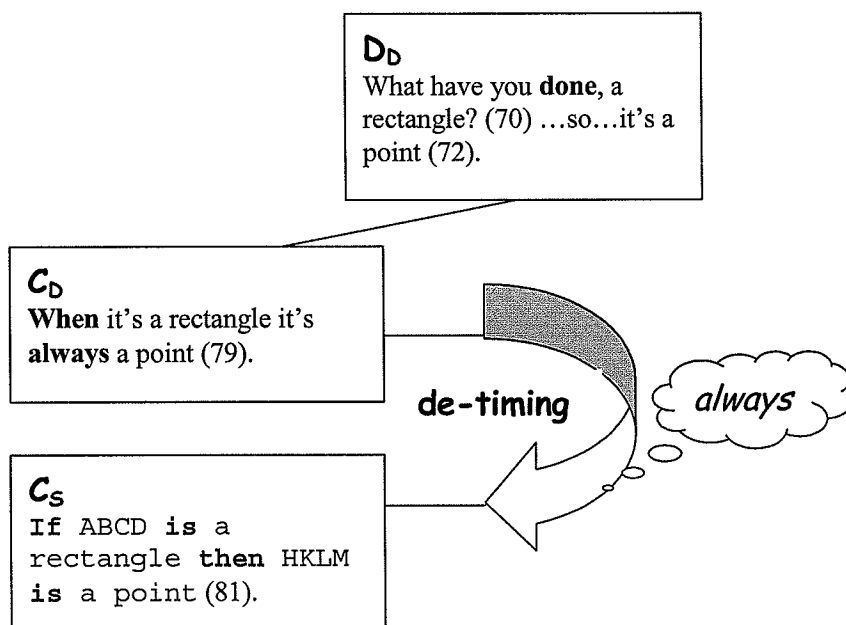

Figure 9.7. B&T. Types of statements

This process (taken from B&T, Extract 6.3, p.120) is a transformation from a dynamic description (D<sub>D</sub>) to a dynamic conjecture (C<sub>D</sub>) and finally to a static conjecture (C<sub>S</sub>). The process starts from an action, in which the figure is transformed into a rectangle and a particular case is described. After dragging to another rectangle configuration, the conjecture is expressed in a dynamic form; the word "always" constructs generality in time,

in that it is observed that the property observed in the particular case happens in other cases too. Once generality has been constructed, there is no longer need for time to be present in the conjecture. So the conjecture is re-formulated in a static way and written in the standard way "if...then". The word *always* is key in the process of de-timing, i.e. of formulating a conjecture which is valid at *any time*. "Always", expressing generality at a visual level is transformed into "if...then", expressing generality at a logical level.

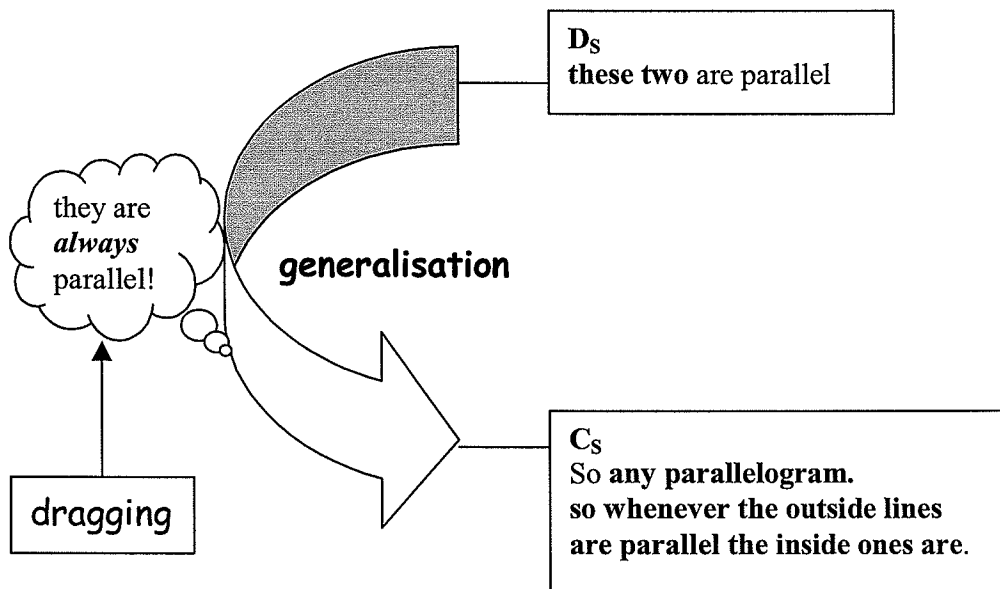

Figure 9.8. A&W. Types of statements

Figure 9.8 (see Extract 8.19, p.191 from A&W) shows another process to get to the final static formulation of a conjecture, that is the process of generalisation. A static description is formulated about a particular figure on the screen. Through dragging Alice obtains another configuration in which the same property can be observed, so that the static description about a particular case is transformed into something that is "always" true. The last step produces a static conjecture, which is a generalisation via dragging of the particular case.

Figure 9.9 below represents the processes of transformations of statements<sup>12</sup>. The two main processes of transformation are generalisation and de-timing, given that the nature of mathematical text is timeless and universal (Morgan, 2001).

<sup>12</sup> These are not to be interpreted as prescriptive, and there is not a hierarchy of statements' production which is followed in all cases.

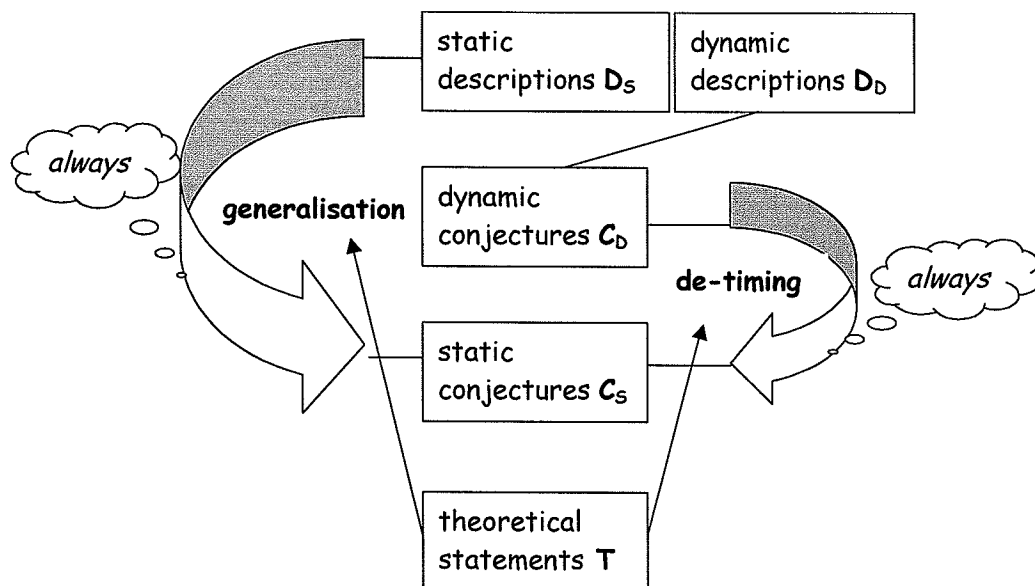

Figure 9.9. Cross case analysis: types of statements

The production of conditional statements may be supported by the production of dynamic conjectures, which are a 'mid-way' between descriptions and static conjectures and are supported by the nature of dynamic geometry environments.

Change is more evident to be perceived by novices than permanence. This is why the simultaneity in the change of appearances is critical for novices because it is a strong external sign of a link between two objects changing exactly at the same instant. (Laborde, 2000, p.158)

It is a matter of focusing on change: in the movement (change of space over time), the conjunction of two phenomena at a given time reveals the link between two phenomena for that particular figure. The formulation of a dynamic conjecture is crucial and a key point for the successive formulation of a static conjecture and eventually the construction of a proof.

Using dynamic geometry software does provide students with access to the world of geometrical theorems but it is access that is mediated by features of the software environment, certainly in the vital early and intermediate stages of using the software. (Jones, 2000, p.81)

### 9.2.5 Emergent and planned interaction with Cabri: what is taken on board?

One of the categories of analysis accounts for the different ways in which students may interact with Cabri: emergent and planned<sup>13</sup>. The identification of the kind of interaction is based on the previous categories (dragging modalities, hiding/showing constructions, thinking/proof sketches and dynamic/static statements), which analyse in detail the elements constituting the interaction with the software and with other tools of the environment (mainly paper). The interaction depends on how much the students let

<sup>13</sup> Emergent interaction is when students are immersed in the software and ideas emerge from it. Planned interaction is when the students use the software according to a pre-planned strategy (see Table 7.6, p.147). Turkle & Papert (1990) deal

themselves be carried away by the software itself and how much they have control of it. This section will explore how the modalities of interaction with Cabri appear in the proving process as a means of creating a different focus and directing the process in different directions.

The analysis of the transcripts allowed refining this category and defining more precisely the two types of interaction. This category generally describes the interaction of students with Cabri throughout the whole proving process. Table 9.4 summarises the type of interaction for all case studies.

	<b>Case 1. B&amp;T- Perp. bis.</b>	<b>Case 2. D&amp;G- Perp. bis.</b>	<b>Case 3. A&amp;T- Varignon</b>	<b>Case 4. V&amp;M&amp;E- Perp. bis.</b>	<b>Case 5. A&amp;W- Angle bis.</b>
<b>Emergent interaction</b>	Tiziana	Debora Giulia	Alessandra Tiziana	Michela Elisa	
<b>Planned interaction</b>	Bartolomeo			Valentina	Alice Will

Table 9.4. Cross case analysis: emergent and planned interaction

The transcript of B&T (see section 6.4.5) shows that the students have different ways of interacting with Cabri. Each student has his/her own way of interacting that is roughly the same all over the process. A planned interaction is prevailing for Bartolomeo. He seems not to be absorbed by the software. He does with Cabri something that he could have done on paper too. He has a precise strategy, which he makes explicit from the beginning of the process ("let's see what happens in every case, shall we?" - see Extract 6.10, p.127), and wants to exploit Cabri in order to carry out this plan. This happens through guided dragging, which is the main modality used by Bartolomeo and suggested to Tiziana when she has the mouse (a paradigmatic example of Bartolomeo's behaviour throughout the process is in Extract 6.1, p.119), by means of which he transforms the initial quadrilateral into particular quadrilaterals and observes what happens to the internal quadrilateral. Photo-dragging characterises his behaviour because dragging itself is only used to transform a figure into another one, and the attention is focused only on the initial and final state of dragging. This shows that Bartolomeo wants to have the Cabri figures under his control and does not carry out free experiments. On the contrary Tiziana shows an emergent interaction with Cabri. She does not show a pre-specified plan of action and she uses Cabri in order to explore the situation and get ideas about it. Her dragging is free; for example while she is

---

with a similar distinction related to programming, distinguishing between "hard mastery", which is "characterized (sic) by a distanced stance" and "soft mastery", characterised by "a closeness to objects" (p.350).

---

trying to get a trapezium, as Bartolomeo suggested, she stops on a parallelogram (see Extract 6.10, p.128). With a metaphor we can say she is 'dragged by dragging', in that she reads what is happening in Cabri while she is dragging. She follows carefully the figure while she is dragging and stops whenever she sees something interesting, doing film-dragging (see Extract 6.3, p.120). She does mostly wandering dragging. Cabri does for her things that she would not be able to do on paper and is an integral part of her actions. The emergent interaction with the software, or with the external context in general, is also shown by the fact that she feels the need for sketching on paper when she cannot have the mouse back at the time she wants (see also section 9.2.3). Even if in this case each student is characterised by his or her own ways of interacting with the software, we can observe two phases in the use of Cabri in the proving process. There is a first phase in which the students require very precise figures in Cabri (with labels for points and lines) and they generally produce the figure they want on the screen before they start proving. In the last phase of the process however, on the contrary, they do not put labels on the figure and their exploration seems to be more free. This may be due to the fact that by that time they manage the situation also from a theoretical point of view and therefore they do not need to have precise figures but Cabri is used more in a 'sketchy' way.

Different modalities of interaction with the software have been observed according to different phases of the proving process in other cases too. In some cases the students have complete control of Cabri (planned interaction), while in some other cases it is Cabri that dominates over the students (emergent interaction). In the case of A&W, the way students interact with Cabri seems to change according to different phases of the process. This is evident from the way they use dragging and they hide or show construction lines. For example at the beginning their dragging is slow and controlled, and happens in only one area of the screen; then at some point it becomes wandering and fast for a while (see section 8.5.1). However, in general the use of Cabri from Alice and Will is quite controlled and they do not experiment much. Their use of lieu muet dragging is significant of their way of interacting with Cabri. As observed in section 9.2.1 (p.206), A&W lieu muet dragging differs from the one carried out by B&T and V&M&E. In the case of A&W, it concerns transformation from one regular quadrilateral (square) into other regular quadrilaterals (parallelogram rhombus, kite). This shows that the dragging is controlled and does not allow seeing other cases outside the regular ones, therefore it is a sign of planned interaction. In the other two cases instead, lieu muet dragging is more free (see section 9.2.1) and shows an emergent interaction with Cabri. In general, D&G and A&T show an

emergent interaction with Cabri, as we can see from their way of dealing with Cabri figures, as discussed in the previous chapter (see section 8.2.1 and section 8.3.1). They take on board the software to the point that the answer they see on the screen is believed to be true even if it contradicts what they found without the software (for example by proving, in the case of A&T). And this way of using the software creates a conflict in students' mind and gets in the way instead of being a support in the proving process. A different approach is shown by V&M&E, who are able to manage the interaction with Cabri in a productive way throughout the whole proving process, both while conjecturing and while proving. Michela and Elisa show an emergent interaction, in that they do free experimentation and Cabri is part of their discovery process. Valentina instead does not use the mouse and seems to want a more planned interaction.

From the analysis, two behaviours come to light with respect to the emergent interaction. It may happen that students are immersed in the software and interpret its feedback correctly (V&M&E) but it can also happen that students are not able to immediately interpret the feedback provided by the software in an appropriate way (A&T and D&G). In this last case conflicts may emerge. Therefore, taking into account the different ways students interact with the software in the proving process is important in order to understand when and how Cabri may be helpful in the construction of conjectures and proofs. As Perkins (1985) says, technologies do not work by themselves and the risk of the "fingertip effect", that is simply making a support system available and expecting that people will more or less automatically take advantage of the opportunities that it affords, is always there. Students do not automatically take on board the software. This takes time and is done differently by different students with different working methods and in different phases of the proving process<sup>14</sup>. "The computer is an expressive medium that different people can make their own in their own way" (Turkle & Papert, 1990, p.348).

### **9.2.6 Synchronous and asynchronous interactions between students: what kind of communication and understanding?**

The fact that the students work in pairs at the same computer and there is only one mouse, provokes them to find a way of working together and interacting. The interactions between students involve internal and external contexts of action. The internal context is what is and happens in the mind of the students; the external context is what is produced and visible (as

---

<sup>14</sup> See also the discussion about the instrumentalisation process in chapter 10 (section 10.2.1).

---

for example Cabri figures, statements, etc). When there are two (or more) students solving the problem at the computer, everyone has his/her own internal context, which has to be externalised in order for the interaction to take place. The analysis of all cases has shown that moments of asynchronous interaction alternate with moments of synchronous interaction, and what is revealed to be most interesting is the way students reach synchronisation<sup>15</sup>. As in the case of student-Cabri interaction, the modalities of interaction between the two (or three<sup>16</sup>) students in the pair (group) can be analysed through the way students use dragging, constructions in Cabri, sketches and through the type of statements they produce. In particular, the use of the mouse may show different modalities of interaction. Students seem to always interact through the computer and not directly between each other and they bring about their internal context to be made explicit in Cabri.

Bartolomeo & Tiziana show a reasonable exchange of the mouse throughout the process (see section 6.4.6). Besides, the person who does not have the mouse usually tells the other person what to do, what to drag and what to construct. The same thing happens with D&G, where it is Debora who has the mouse most of the time, because Giulia “cannot do it”, as she explicitly says when Debora offers her the mouse. In this case again, Giulia directs Debora in the dragging. The way the other student reacts to these directions and faces this situation is different. In the B&T analysis, moments of asynchronous and synchronous interaction can be clearly identified, and Cabri constitutes a shared workspace in which and through which the students communicate and move from asynchronous to synchronous interaction (see Extract 6.10, p.128). From asynchronous interactions, in which the two students focus on different things looking at the same situation on the screen, a progressive focusing towards the same elements seem to occur thanks to dragging and making explicit each other's internal contexts. In the case of Debora and Giulia moments of synchronous and asynchronous interactions are identified too. There are episodes in which it is very clear that it is the person with the mouse who guides the solution process (see e.g. Extract 8.2, p.160), but there are other cases in which it is clear that they are working on the same problem on the same figure (see section 8.2.3). Alessandra and Tiziana show an alternate use of the mouse, according to who has ideas about what to do. In the A&W case, it is Alice who has the mouse most of the time, apart from two very brief moments. However,

---

<sup>15</sup> For a definition of synchronous and asynchronous interaction see Table 7.7, p.148.

<sup>16</sup> For the purpose of this research, issue concerning the difference between a pair and a group of three students regarding interactions between students were not taken into account.

they seem to show synchronisation most of the time and do not use Cabri necessarily as a shared workspace. For example they have two sheets of paper that they use separately for some time in the process. In the case of V&M&E, it comes out quite clearly that Valentina always seems to be working at a different level from the other two (see Extract 8.11, p.177), her internal context seems to bring about theoretical inputs more than for Michela and Elisa. Her way of interacting with Cabri seems to be planned (she takes the mouse only once and for a very brief period), while the other two students are characterised by an emergent interaction (see section 9.2.5). So they are not synchronised.

The modalities of interaction through the mouse that were shown in the analysis can be summarised as follows (students A and B working in pairs).

- A has got the mouse and knows what to do and B does not have the mouse and does not know what to do. There is conflict in terms of students' internal contexts, in that B cannot follow what A is doing (e.g. B&T, Extract 8.22, p.197). B needs to stop A moving (e.g. D&G, Extract 8.2, p.160) and possibly to get the mouse.
- A has got the mouse but does not know what to do and B does not have the mouse but knows what to do. The rhythm is either established by the subject who has ideas and the other follows with the mouse or the one with ideas is not able to impose them and has to wait or to go to paper (e.g. B&T, Extract 6.8, p.123).
- Both A and B know what to do. They usually exchange the mouse quite often, or at least both of them require the mouse often (e.g. the case of B&T). It is always the one with the mouse who succeeds in doing things in the way he/she likes (e.g. B&T, Extract 8.22, p.197).
- None of them know what to do. The one with the mouse starts doing some dragging, usually wandering (e.g. D&G, Extract 8.1, p.157).

The mouse lets you enter the Cabri space. It is needed in order to manage the situation and to have a direct Cabri experience. This might be much more important when the students do not have a clear picture of what is going on yet, and they need to do experiments in the external context. When having the mouse, most of the time the students do not make explicit what they are doing, they just do it in Cabri (see V&M&E, Extract 8.10, p.175). The person who does not have the mouse usually tells the other person what to do, what to drag and what to construct (see B&T, Extract 8.22, p.197). This is a way to produce synchronisation. Different answers to this input are then observed: it may happen that the



---

person having the mouse either follows the instruction or not, creating either synchrony or continuing with moments of asynchrony. And consequently there may be a request to have the mouse back ("can I?... let's try something"). The ownership of the mouse, i.e. the possibility of manipulating figures in Cabri, seems to be a relevant part of the interaction between the students and of the proving process and lets the person be embedded in the Cabri external context. Students can get to a synchronisation and communication within the Cabri space, without needing to talk (see section 9.3.2).

### **9.3 DEVELOPING AN EXPLANATORY FRAMEWORK. LINKING STORIES**

Two key points emerge from the intersection of all stories:

- the ascending and descending processes between the spatio-graphical field and the theoretical field being at the core of the proving process (discussed in section 9.3.1) and
- the idea of Cabri constituting a shared workspace in which internal contexts can be made explicit, communicate and evolve (discussed in section 9.3.2).

These two ideas link all categories in two frameworks, which will then be unified in a common explanatory framework, discussed in section 9.4.

#### **9.3.1 Ascending and descending processes: constructing a bridge between the spatio-graphical field and the theoretical field**

The category describing ascending and descending processes between the spatio-graphical field and the theoretical field is based on the analysis of all the other categories, which can provide elements to identify what kind of interaction between the spatio-graphical field and the theoretical field is taking place at different moments of the proving process. The interplay between the spatio-graphical field and the theoretical field produces the transformations on objects and on statements which are the key point of the formulation of conditional statements aiming at the construction of conjectures and proofs (see chapter 7). Figure 9.10 shows the different role played by the categories analysed within the interplay between the spatio-graphical field and the theoretical field. Ascending and descending processes control the interplay and each tool (category) is used prevalently within ascending or descending processes and relates prevalently to the spatio-graphical or theoretical field, as explained below.

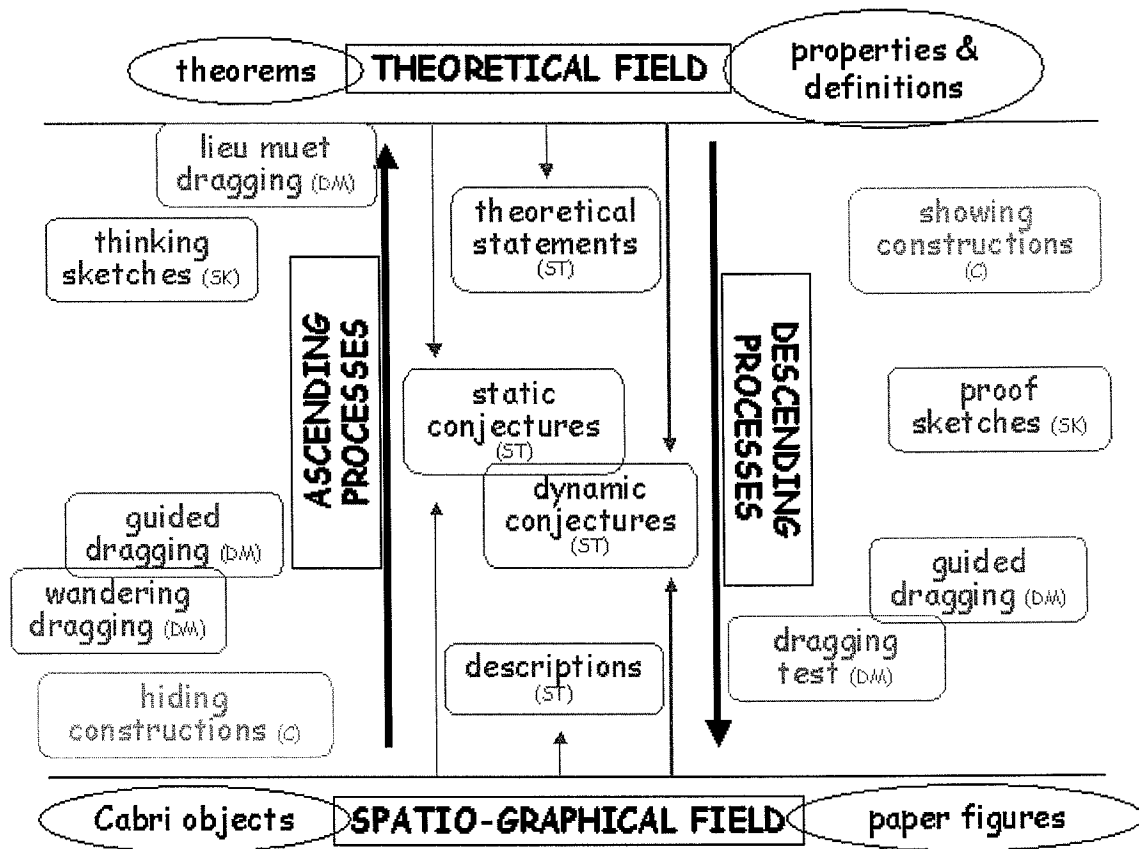

Figure 9.10. Ascending and descending processes

**Dragging.** As discussed in section 9.2.1, different dragging modalities can be used with respect to different aims in the proving process and can therefore be associated to both ascending and descending processes. In general, possible sequential developments of dragging modalities during the process can be identified<sup>17</sup>, as represented in Figure 9.11. This development from one modality into another provides a change in focus: different elements are focused on through the use of dragging.

<sup>17</sup> Even if it may happen that students do not use all of them.

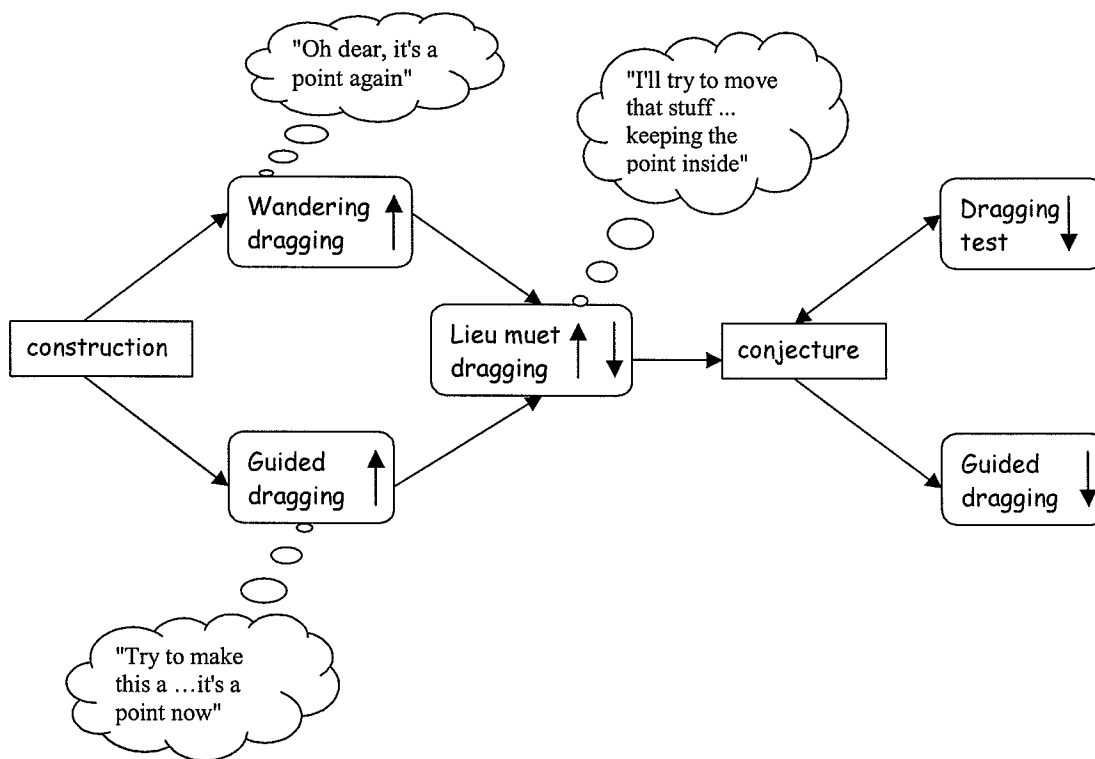

Figure 9.11. Development of dragging modalities<sup>18</sup>

From the cross case analysis concerning the use of dragging, the key finding is that *lieu muet dragging* is the crucial modality, which fosters the production of general conjectures, transforming descriptions or facts into conditional statements or relationships. The key point is that *lieu muet dragging* involves a change of focus from the external figure<sup>19</sup> (hypothesis) to the internal figure (thesis) and back again to the outside one (new hypothesis). An interesting configuration is seen (for example the internal quadrilateral becomes a point) while the students were not focused on the internal quadrilateral but just transforming the external one. The focus is then on the internal quadrilateral (thesis) which is now fixed. By moving the external quadrilateral so that the internal one keeps the discovered property, both quadrilaterals are looked at, at the same time, and the movements and change of both are simultaneously under control. While doing *lieu muet dragging*, students can observe some regularity of the external quadrilateral happening when the internal one has a certain property (e.g. they can observe that the sum of opposite angles of the external quadrilateral is the same

<sup>18</sup> The arrows next to the dragging modalities identify ascending or descending processes.

<sup>19</sup> This refers to the problems used in this study, i.e. problems concerned with two figures (referred to as external and internal) linked by some constructions (angle bisectors, perpendicular bisectors, midpoints).

while inside there is a point). At the end of the dragging, the focus has to shift from the internal figure to the external one again and a new way of looking at the very same situation needs to take place. Dragging suggests that if the internal figure is a point then the external quadrilateral has the sum of opposite angles equal, but the conjecture to be made is that if the external quadrilateral has the sum of opposite angles equal then the internal quadrilateral is a point. In order for this to happen, the properties of the external quadrilateral that are seen under dragging (in the spatio-graphical field) need to be connected to the geometrical properties (in the theoretical field). That is, one needs to understand 'what rule this is the case of'. The underlying cognitive process is that of abduction (see Arzarello et al., 1998b; Olivero, 1999 and chapter 2, p.40).

**Hiding and showing constructions.** The action of hiding constructions was seen to be used mainly in the conjecturing phase, i.e. as a means to explore the spatio-graphical field within an ascending process. On the contrary leaving construction lines visible was a sign of a theoretical control over the Cabri figure and of a descending process, in that the figure was looked at from the point of view of the geometrical properties (of angle bisectors or perpendicular bisectors). The use of both ways allows students to change the focus on different things where appropriate and to let theoretical elements emerge.

**Paper sketching.** The analysis shows that sketching is not a purely spatio-graphical activity. Sketches are rather produced when a theoretical control over the Cabri figures is needed, either consciously or unconsciously, from the students. Cabri figures can be moved only by dragging the free points, that are the vertices of the external figure, i.e. by acting on the hypothesis (if ABCD is a ...). However, after an interesting configuration is seen or conjecture discovered (i.e. a thesis formulated), students may feel the need to fix that configuration. In order to do it in Cabri they would need to reconstruct the external quadrilateral according to the new hypothesis which have that thesis as a consequence, but this may take a long time. Therefore in this case paper sketches may serve the purpose of drawing a figure with all the properties students want, in an easier and quicker way.

**Types of statements.** Static conjectures and dynamic conjectures are put in between the SG and the T field because they can come both from the spatio-graphical field, for example in the form of description of a Cabri figure straight at the beginning of the process and from the theoretical field, if they come at the end of a discovery process, in which the Cabri

---

figure has already been interpreted within the theory and properties have been found. Descriptions belong to the spatio-graphical field, since they involve only visual and perceptual observations. Theoretical statements obviously belong to the theoretical field. The evolution of the production of statements marks a change in the way students look at figures on the screen, going from pure descriptions of what they see in the spatio-graphical field to focusing on relationships between different figures until an interpretation of these relationships within the theory occurs and conjectures are formulated together with proof statements.

Even if each category has been given a place in the space between the spatio-graphical and the theoretical field and within ascending and descending processes, the real development of the proving process involves many shifts between spatio-graphical and theoretical field (as shown by the examples analysed in chapter 8), within a general main one, as represented in Figure 9.12. In general, the proving process can be seen as a transition from a first phase in which students explore the situation to a second phase in which they want *to know why*. The first phase is ascending because the students explore, being influenced by their internal contexts, maybe implicitly. It is a creative process. At some point exploration stops and the discoveries are organised and 'crystallised' into conjectures. A descending process then starts in order to understand why the conjectures are so. The conjecture 'if A then B' is broken into pieces (Rav, 1999) and elements of explanations are constructed. This is an interpretative work, which does not have a fixed final endpoint. The amount of things that need to be made explicit varies according to the students involved. Within this main transition, there are continuous shifts between ascending and descending processes between the spatio-graphical field and the theoretical field. These help students to focus on different things relevant to the proving process and to let properties of figures emerge from Cabri and evoke theoretical elements. So the whole proving process is not constituted by *one* transition from empirical (within the spatio-graphical field) to theoretical (within the theoretical field) practices, but the key point is the change of point of view with respect to the same situation. The bridge between the two fields towards the construction of conjectures and proofs does not happen automatically and cannot be taken for granted. Examples have shown that students may experience a conflict between the two fields (see the cases of D&G and A&T) and the intervention of the teacher is needed to make the transition from ascending to descending processes, in which figures in the spatio-graphical field are looked at from a different perspective. In fact, during the ascending process, the figure is looked at from an empirical point of view, because the aim is to explore and look

for properties and conjectures. In the descending process, instead, the geometrical properties of the figure need to be accounted for: the figure must be seen as a generic example (Balacheff, 1999). "You can reason with diagrams if you know the rules for reading and writing them" (Noss, 1995, p.5).

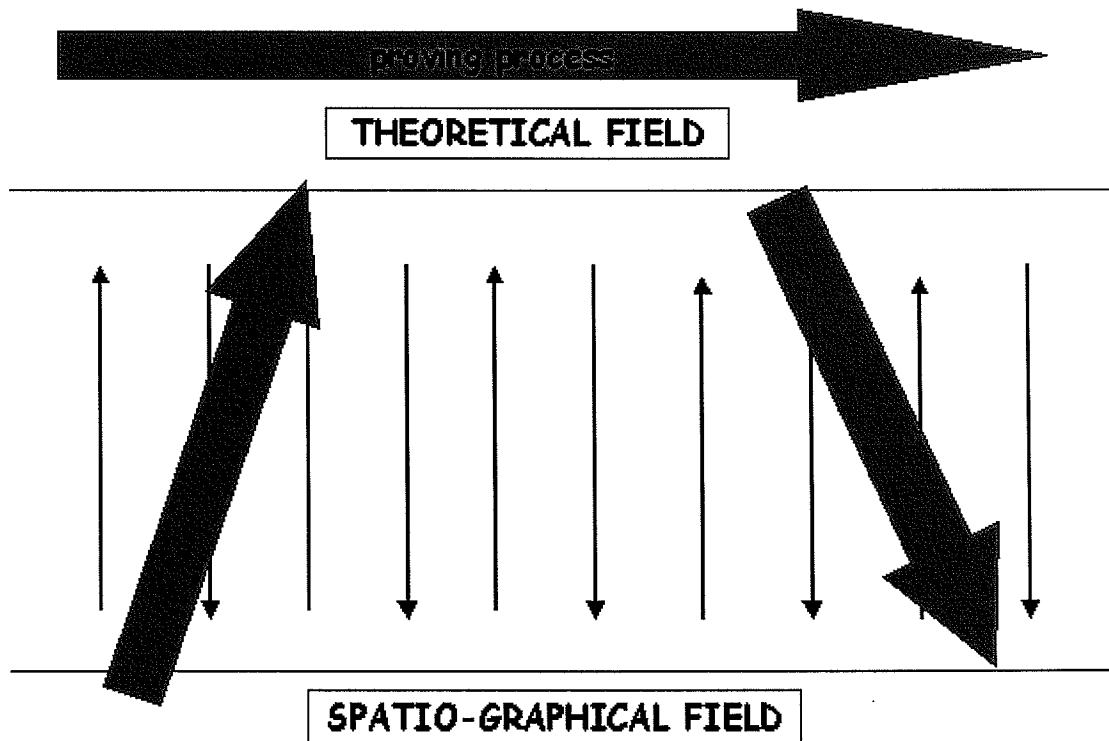

Figure 9.12. The proving process as a sequence of ascending and descending processes

### 9.3.2 Cabri as a shared workspace

There is a need for microanalysis of all the interactions in a computer context, i.e. *inter-pupil* and *pupil-computer*. We need to know the outcome of the activity but also the processes by which this outcome has been achieved. We need to distinguish what the pupils are talking about - screen output, the underlying mathematical issues or the links between the two. One would hope that such an analysis might uncover significant incidents and critical decision points whereby pupils come to experience their mathematics in a different way and to see it in a new light. (Hoyles, Sutherland, & Healy, 1991, p.164)

When approaching a particular open problem each student brings his/her own *internal context*, deriving from both experiences and knowledge, present and past, into the process which is taking place in the *external context* (i.e. the context in which the students are working, mainly Cabri in this case).

The categories which describe the movements and interactions of external and internal contexts, as they emerged from the analysis of the case studies, are represented in Figure 9.13.

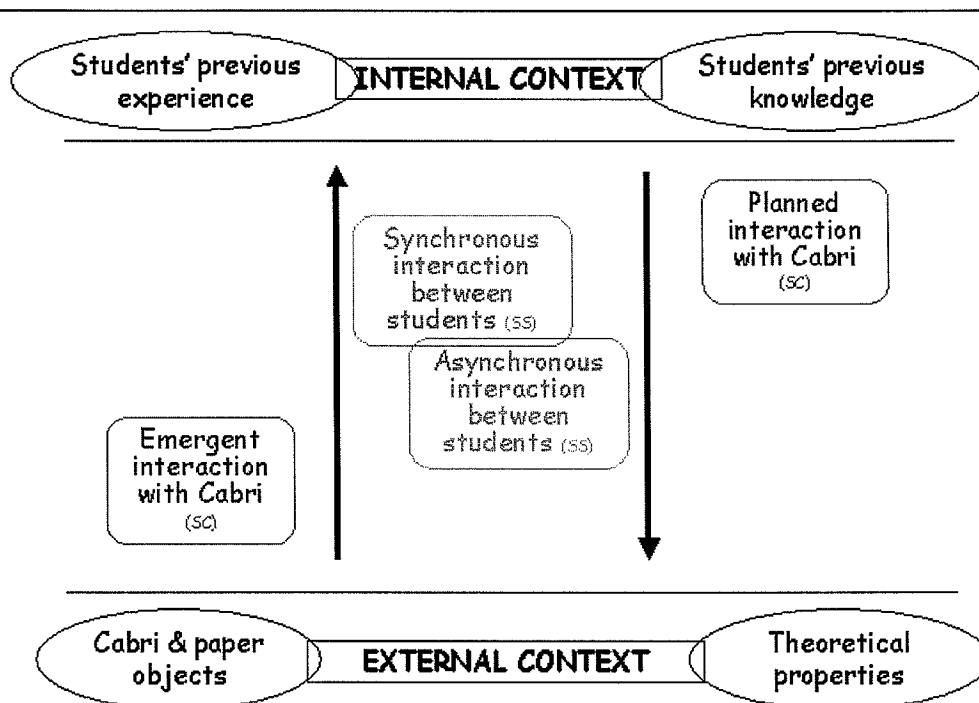

Figure 9.13. Movements between internal and external contexts

**Emergent and planned interactions.** The different types of interaction of the students (emergent or planned) with the software and the ways in which the students incorporate (or not) the software in their thinking over the proving process both play a role in the interactions of internal and external contexts. Emergent interaction relates more to the external context because it identifies behaviours in which students are immersed in Cabri (see section 9.2.5). Planned interaction is situated closer to the internal context because it describes behaviours in which students control Cabri from the perspective of their internal context.

**Synchronous and asynchronous interactions.** These interactions manage the back and forth moves between the external and internal contexts, as explained below.

While solving an open problem, the internal context of each student is projected into the problem situation. Using a metaphor, this projection forms two different 'shadows' in the external context. As Figure 9.14 shows, at the beginning of the process it is likely that the two 'shadows' do not intersect, as the students' internal contexts may be different. The starting point may be a state of asynchrony. During the process there is a continuous feedback from the external context to students' actions, therefore the internal context is

---

constantly modified, and a process of "internalization"<sup>20</sup> (Vygotsky, 1978, p.56) takes place, so that the external tools (Cabri tools) may be internalised as psychological tools which direct students' behaviour in solving the problem. The students see things in Cabri and they relate what they see to their internal context, therefore they may see different things on the same figure. They work on what they see and they transform it. They produce statements. But at the same time through the 'shadows' the students start to interact with each other's internal contexts and intentions. A point may be reached in which the projections of the two internal contexts intersect (Figure 9.15). When this happens it means that the students are communicating and working together on the same issues. Synchronisation may then take place. The internal context is then continuously modified by both the feedback from the Cabri environment and the interaction with the other student. The projection of the internal contexts in the external context should be imagined as dynamic, so that at times the intersection exists and at times it does not. The moments in which the intersection exists are the moments in which there is the construction of joint understanding and knowledge, which may support the production of conjectures and proofs. The moments of synchronisation do not necessarily coincide with the development of well-formed logical statements. In fact it seems that if there is a synchrony between the students they understand each other perfectly through the external space (mainly Cabri) without finding the need of developing a well-formed logical language. Things can be seen and understood in Cabri, without any need for explicit logic and Cabri becomes part of students' interactions. As Teasley & Roschelle (1993) state,

students are not wholly dependent on language to maintain shared understanding. In fact, one major role of the computer in supporting collaborative learning is providing a context for the production of action and gestures. (p.238)

---

<sup>20</sup> "The process of internalization (sic) consists of a series of transformations: (a) An operation that initially represents an external activity is reconstructed and begins to occur internally. [...]. (b) An interpersonal process is transformed into an intrapersonal one. [...]. (c) The transformation of an interpersonal process into an intrapersonal one is the result of a long series of developments" (Vygotsky, 1978, p.56-57).



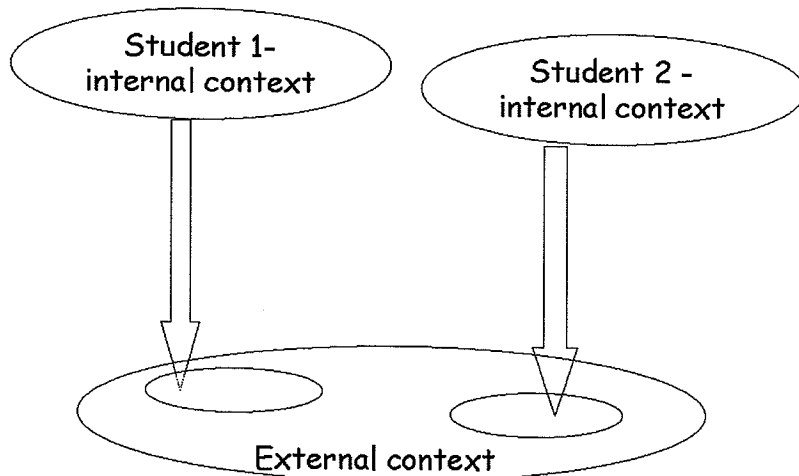

Figure 9.14. Two different internal contexts are projected onto the external context

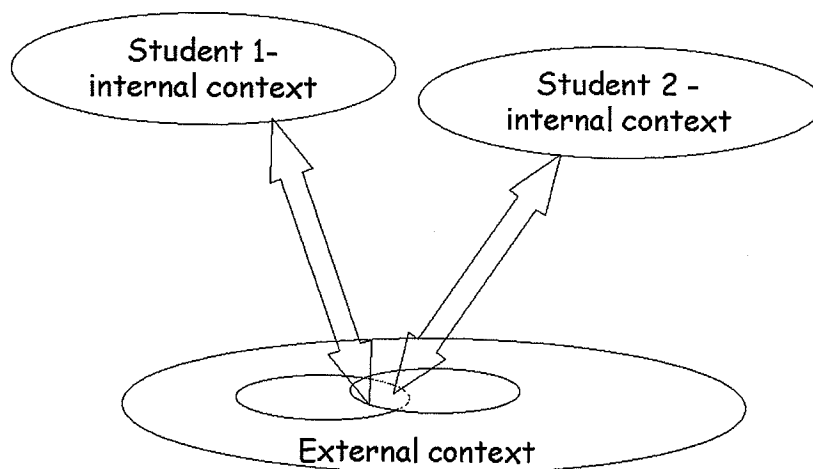

Figure 9.15. The internal contexts communicate through the external context.

Summarising, the analysis of the data suggests that the Cabri environment is revealed to be a *shared workspace* for students, that is a space in which students communicate and converge towards a shared understanding.

Already A has some insight into the state of B's understandings, the meanings which are evoked for B by the problem or the situation. [...] The computer has brought an arena in which A and B's understandings can be externalised. (Noss & Hoyles, 1996, p.5)

Entering another's *universe of thought* (Kieran & Dreyfus, 1998) in Cabri may be easier than in paper and pencil, because of the possibility of moving figures on the screen which contrasts with the fact that figures on paper are static. Both the background knowledge and the knowledge being constructed over the solution process can be expressed, changed and explored via dragging in Cabri.

A has now a language with which to interact with B, the language of action in which ideas on the computer are expressed. [...] A and B both have a two-way channel of communication with the computer, and in establishing these channels, it (actually the setting) has opened a channel from B to A where previously the direction of communication was essentially one-way. (Noss & Hoyles, 1996, p.5)

Seeing the dynamic variation of figures on the screen allows interactive participation of both students to the same experience. At the beginning it seems that the one who has got the mouse leads the solution process, however it is observed that once figures start moving on the screen also the other person is allowed to enter the experience and process of discovery. This process in Cabri always starts with an ascending process, which seems to be the pre-requisite for the construction of shared knowledge or understanding<sup>21</sup>. The possibility of direct manipulation of Cabri objects through the mouse makes Cabri an external space in which the two subjects can interact and communicate, trying to *synchronise their internal contexts*.

#### **9.4 DEVELOPING AN EXPLANATORY FRAMEWORK. A NEW STORY: PROVING AS A FOCUSING PROCESS**

The previous section elaborated two frameworks, which link the categories of analysis in two groups. This section will provide a general framework, which describes and explains the development of the proving process in a dynamic geometry environment.

The analysis presented in the previous sections leads to the interpretation of the proving process in a dynamic geometry environment as a progressive *focusing process* which occurs within the Cabri environment, that works as a shared space of communication. The proving process occurs as a combination of ascending and descending processes between the spatio-graphical field and the theoretical field, which take place in the external context and exchanges between the internal contexts of the students and the external context in which they are working. These dynamics allow a progressive focusing to take place.

As discussed in chapter 2 (section 2.6), the proving process involves the activities of exploring, conjecturing and proving, which evolve and intersect with one another in the solution process of an open problem. Objects and statements are to be transformed from particular to generic, from facts to conditional statements. The analytical framework (chapter 7) identified elements to be observed in the proving process within the general idea of observing the shifts between empirical and theoretical practices. Two main transformations were chosen as a focus of observation: transformations of objects and transformations of statements (see Figure 7.19). The process of transforming can be

---

<sup>21</sup> On the contrary, with paper & pencil the process is mainly descending, because I first need to know what I want to draw before actually drawing it. Therefore it is the person who has got the pencil who decides which trace to draw. Once the drawing is made, it is static and embodies what the person who made it wanted it to represent. There is no possibility of variation, so that the other person has to see what the drawing embodies, otherwise the communication does not happen.

---

described as a progressive *focusing process*, in which new elements (figures, statements and relationships among them, theoretical elements) emerge over time and are focused on. The analysis has shown that the transformations of objects and statements are ruled and happen through the ascending-descending shifts by which students manage the interaction between the spatio-graphical field and the theoretical field (see section 9.3.1). All this is part of the external context, which is the context in which students act and talk. This external context interacts with the internal context which is what each individual student is thinking about, i.e. previous knowledge and experiences. Movements between external and internal contexts, in which the internal contexts are projected onto the external context so that students can interact and at the same time are modified by the external context through a continuous feedback (see section 9.3.2), contribute to the focusing process too, as they direct where the focus is going to be. The stories of the two students working on the same problem merge into a new one. The transition from empirical practices (in the spatio-graphical field) to theoretical practices (in the theoretical field) is provided by the progressive *focusing*, which allow theoretical elements to emerge from the spatio-graphical field and be used and related to previous knowledge towards the construction of proofs.

Figure 9.16 below represents the explanatory framework for the development of the proving process within a dynamic geometry environment.

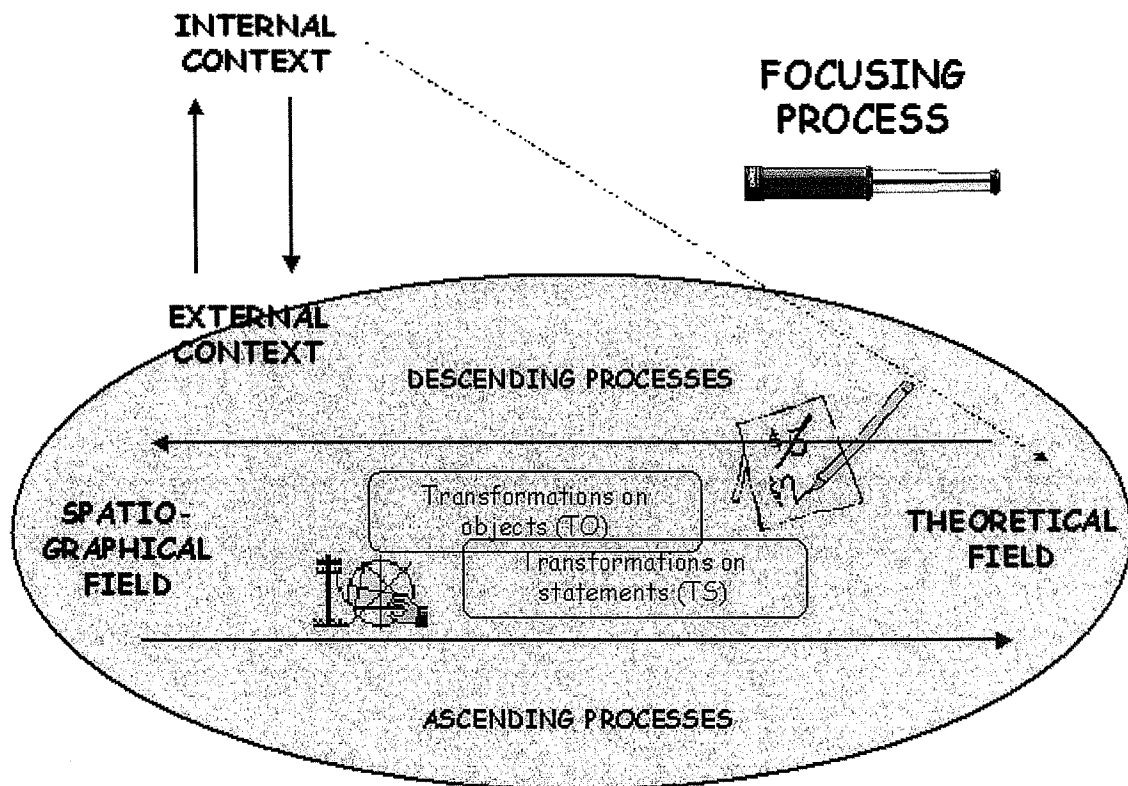

Figure 9.16. The focusing process as a combination of ascending-descending processes between the spatio-graphical field and the theoretical field and interactions between the internal and external context.

The idea of the focusing process to explain the evolution of the proving process, relates well to the idea of “developing the ‘geometrical eye’” (Fujita & Jones, 2002, p.384), taken from Godfrey. Godfrey (1910) wrote that an important power is necessary to solve mathematical problems, that he called *geometrical power*, defined as “the power we exercise when we solve a rider. [...] Riders cannot be solved by logic alone” (Godfrey, 1910, p.197). In order to develop the geometrical power, Godfrey said that it was necessary to train what he called the *geometrical eye*, which he defines as “the power of seeing geometrical properties detach themselves from a figure” (Godfrey, 1910, p.197). Fujita & Jones (2002) illustrate the idea of geometrical eye with an example. Consider the problem: if A and B are the midpoints of the equal sides XY, XZ of an isosceles triangle, prove that  $AZ=BY$ . In order to be able to prove this one needs to ‘see’ first of all that, for example, triangles AYZ and BZY are likely to be congruent. The authors argue that Godfrey’s notion of geometrical eye might be a potent tool for building effectively on geometrical intuition, by linking it more directly with geometrical theory. In fact, developing the geometrical eye,

---

can be seen as developing the capacity of focusing on the appropriate objects at the appropriate time in the process and being able to change focus whenever needed, whenever new elements are discovered, whenever new theoretical elements emerge. Therefore, managing the *focusing process* is a way to make the transition from empirical to theoretical practices happen, and moreover to be managed throughout the proving process. In fact there is not a one way transition to be made, but what is to be achieved is the capacity to link empirical and theoretical elements throughout the proving process, in order to build from both (see Figure 9.12, p.227).

The key element of the *focusing process* is the possibility of having a field of experience (provided by Cabri, paper and pencil etc) which allows students to manipulate, interact, and change the objects they deal with: it is an empirical experience which is likely to evoke theoretical elements. Therefore, the fact that students are able to get involved in what is happening and are able to express what is happening constitutes the basis for the transition to the construction of theoretical knowledge. Students need to experience the environment, through actions and observations, until it becomes a field of experience in which they are immersed. Another key element in the *focusing process* is the way problems are posed to students. If students are presented with close problems of the form 'prove that' or asked to work with paper & pencil only, the involvement in the field of experience is not possible as they have an already established result that needs to be proven, but they do not have the possibility of 'playing' with the objects involved. The formulation of closed problems requires actions within the theory (deductive structure of mathematics) since the beginning and this may be very difficult for students. They are not allowed to 'enter' the problem, experience it, and through that 'enter' the world of theory.

#### **9.4.1 Tools for focusing**

The statement of an open problem requires the exploration of a situation, which at the beginning is very open, in that many paths may be taken in order to discover conjectures and construct proofs. "Theorems are the headlines, proofs are the inside story" (Rav, 1999, p.22). A number of tools are available to the students, in the form of objects (drawings and figures on paper and in Cabri) and actions they can do with these objects. These objects are situated in space and time and change status and meaning over time: they become signs of a situation that is evolving. "Participating in the development of a diagram through animation over time adds significantly to the story-telling, sense-making features of the diagram" (Mason & Heal, 1995, p.301), moreover the possibility of moving objects in space and

consequently in time, makes things emerge progressively and become clear, i.e. in focus. At the beginning of the process everything seems to be very vague to students, there are objects which are not always linked to one another and relationships are feeble or do not exist at all. As time goes by, a progressive *focusing* occurs so that important relationships begin to emerge and form a *web* of objects and statements somehow related (Noss & Hoyles, 1996), which culminates in the construction of conjectures and proofs. The way the students use dragging and construction elements, more generally the way they interact with the software, and the way they interact with each other (accounted for by the categories of the analytical framework - see chapter 7) are *tools for focusing*, and each one contributes to the *focusing* in a different way, as described below.

**Dragging modalities.** With wandering dragging, from a random exploration of a situation some regularity or invariance emerges and is focused on. Guided dragging is a way of creating a focus on a particular figure, which has been previously discovered or thought of. With lieu muet dragging a change in how the figure-situation is seen takes place, and new relationships are seen and placed in the *web* which is being constructed. Students usually do not do dragging when constructing a proof. This is because all elements are in focus after formulating the conjecture.

**Hiding and showing construction lines.** This Cabri tool is a focusing tool in itself, because the possibility of showing or hiding elements allows focusing on different things. When the construction lines are hidden, no focus is on the construction, which may then be forgotten, i.e. the geometrical properties necessary for proving (the hypothesis) may not be used because they are 'hidden'. There is a strong link between what you see and what you use in constructing a proof. And given that in Cabri you can decide what to show and what to hide, you may have control over the theoretical elements you want to use. Some lines may be hidden and then shown again; some other lines may be added and then deleted. The possibility of doing this allows you to focus on different things at different time, i.e. to 'see' and let emerge a broad range of properties which may lead to successful conjecturing and proving.

**Sketching on paper.** When using sketches, the film of the proving process is stopped for a moment because some elements are seen in focus and the students want to work on them on the spot.

**Interacting with Cabri.** A planned interaction with Cabri shows the intention of using Cabri as a means for focusing on some elements which have emerged before and are

---

part of students' internal context, either from previous exploration or from the theory. Emergent interaction allows elements to emerge from the Cabri figure and different elements may be taken on board by different students or at different phases of the process.

**Interacting within the pair.** When there is synchronous interaction, two disconnected ideas-perceptions-theoretical elements are put together and create something new, i.e. *focus* on some new elements which make the situation evolve. Each student is telling his/her own story throughout the process and they are seeing different things in the same situation. The two stories may go on separately at times, but the fact that students are working in pairs fosters the need of making things explicit to each other. When there is asynchronous interaction, the process of focusing is going on independently for the two students, who look at different things and are not in tune with each other.

## 9.5 SUMMARY

This chapter has developed an explanatory framework, in which proving in a dynamic geometry environment is interpreted as a *focusing process*, made of a combination of ascending-descending processes between the spatio-graphical field and the theoretical field and interactions between the internal and external contexts. The *focusing process* in Cabri consists of constructing and entering the relationship *if A then B* until the students involved are satisfied with the explanation for the truth of the statement. This happens though using the *tools for focusing*, which were identified in students' proving processes.

Interpreting the proving process as a focusing process may provide a theoretical explanation for how Cabri is useful for the construction of proofs, even if it is not directly used in that phase (as the transcripts have shown). The influence of Cabri in the construction of the proof relies on the fact that it gives you the idea for the proof. While working in Cabri during the discovering process many elements become visible, because of the fact that you can move the figure. The figure can be seen from different perspectives, everyone can see different things on the same figures and many things because it is dynamic. Once you focus on some particular elements, then these elements could be the same ones to be used in the proof (as was shown in the extracts from A&W and D&G analysed in chapter 8). What is important is that you get the idea for the proof. And of course a proof can centre around many different things (properties, figural elements), so it is important to have a starting point. This justifies a possible continuity between the key elements of the conjecture and the key elements of the proof. So even if Cabri is not

directly used in the construction of the proof, it plays a very important role in determining the key elements to focus on and as such provides a *cognitive unity* (Boero, Garuti, & Mariotti, 1996) between conjecturing and proving. If we compare it to paper and pencil, in that environment you would not have that much flexibility. Starting with a figure on paper requires you to decide what figure you want to draw first. And then the figure is static; it is the same throughout the discovering process and cannot be moved or changed continuously. Drawing a new figure is not the same thing, because it constitutes a break in the flow of the process. So it is more difficult to see the figure from different perspectives and let key elements come evident to your eyes.

The next chapter will bring together the whole 'story' and discuss conclusions and implications regarding the *focusing process* from the point of view of the research and the possible use of the *focusing tools* from practitioners (teachers).



---

## CHAPTER 10. CONCLUSIONS AND IMPLICATIONS

*Diagrams have been used in many periods of mathematical development, but the static diagram has a number of draw-backs. A diagram usually develops over time, and the author's clarity is achieved through that sequential growth. However, when complete, derivation and sequence dynamic is lost. The diagram is a particular picture, but can't directly express in what way it is particular. Participating in a development of a diagram through animation in time adds significantly to the story-telling, sense-making features of the diagram. Being able to move screen objects around in space (and so over time) can add significantly to the user's sense of the underlying concept as an object not just in itself but as something invariant amidst change.*

(Mason & Heal, 1995, p.301)

### 10.1 INTRODUCTION

The main aims of the thesis were:

- To investigate the development of the proving process (i.e. the construction of conjectures and proofs) within a dynamic geometry environment.
- To investigate the interactions taking place in the proving process.

The thesis explored the ways students use Cabri when working with open geometry problems involving conjecturing and proving. A detailed analysis of students' transcripts was carried out in relation to an analytical framework and an explanatory framework interpreting what students do while using Cabri and how they interact with the software and between each other was developed. The analytical framework framed what were considered to be key elements to be accounted for in order to understand the development of the proving process within a dynamic geometry environment. Then all these elements (categories of analysis) were related to one another through the analysis of transcripts and an explanatory framework was finally developed. The main result of the research is that proving develops as a focusing process within a dynamic geometry environment. This

result has an impact at the level of teaching practice too, providing suggestions for teachers who want to use dynamic geometry as a support for proving activities in the classroom.

This chapter is divided into three sections. The first section brings together the whole dissertation, highlighting the main results addressing the research aims. The second section discusses the impact this study may have on mathematics teachers. Third, the limitations of this research are considered and ideas for further research, addressing points that still need investigation, are presented.

## 10.2 THE PROVING PROCESS WITHIN A DYNAMIC GEOMETRY ENVIRONMENT

The aim of the study was to tackle one of the difficulties students face when they approach proving problems in geometry, that is the gap between empirical and theoretical elements to be used in the proving process. Different stories of different students showing different ways of using Cabri in open geometry problems involving proving were explored. Through these stories an analytical and explanatory framework emerged to describe and interpret the development of the proving process within a dynamic geometry environment.

As discussed in the previous chapter, the framework showed that proving in a dynamic geometry environment develops as a *focusing process*, in which the shifts between ascending and descending processes and the interplay between internal and external contexts appear to be key elements for the construction of conjectures and proofs. The process of *focusing* as students solve open geometry problems was analysed and *tools for focusing*, used by students in the process, were identified. The different impact of each of these tools was studied and a framework developed. It was shown that Cabri provides a space in which progressive focusing is likely to take place. This relates to the fact that Cabri is a dynamic geometry environment and as such it allows a process of “story-telling” (Mason & Heal, 1995, p.301), in which, according to the elements students see and focus on while telling the story in Cabri, different conjectures and elements for proving may appear. The process of focusing depends both on the process the students are involved in within Cabri while tackling the problems and their past experience. Moreover, both the interaction of single students with the software and the interactions between students are important tools for focusing. Each student is telling his/her own story and the interaction between the students merges, integrates and changes the single stories into a new common one. Moments of synchrony and asynchrony were observed throughout the process, showing that both collaboration and individual work are important, provided that there is the possibility of sharing experiences in a common workspace. Cabri worked as a shared

---

workspace, i.e. as a space which supported the construction of shared knowledge. Cabri is a space in which the students' internal contexts (including previous knowledge and experience) can be made explicit and an intersection between them is supported. Therefore communication between internal contexts becomes possible, because students share a common language, which is the language of Cabri (language to be interpreted broadly, for example including dragging). And at the same time an evolution of internal contexts takes place in the forms of internalisation (Vygotsky, 1978), thanks to the interactions between them through the external context and to the feedback provided by the external context.

Beside the dynamic of Cabri, another element is fundamental for the focusing process to take place, i.e. the type of problems students work with. In fact, the focusing process relates to the possibility of exploring and experimenting. It is conjectured that if students are presented with closed problems of the form 'prove that' or asked to work with paper & pencil only, the involvement and experimentation in the field of experience is less likely to happen, as they have an already established result that needs to be proven, but they do not have the possibility of 'playing' with the objects involved. As Mason & Heal (1995) say, "participating in a development of a diagram through animation in time adds significantly to the story-telling, sense-making features of the diagram" (p.301), therefore students should be given the possibility of experiencing this. The formulation of closed problems requires actions within the logic-deductive structure of mathematics from the beginning (given that a statement of the form if...then is a starting point). Students are not allowed to 'enter' the problem, experience it, and then 'exit' again in the world of logic. The influence of Cabri in the construction of the proof relies on the fact that it may provide students with ideas for the proof, as part of the focusing process. While working in Cabri during the discovering process many elements become visible, through dragging and observing the figure in motion. The figure can be seen from different perspectives, everyone can see different things on the same figure. Once you focus on some particular elements (through dragging or hiding/showing construction elements or sketching), then these elements may be the same ones to be used in the proof. What is important is that you get the idea for the proof. And of course a proof can centre around many different elements (properties, figural elements), so it is important to have a starting point. A continuity between the key elements of the conjecture and the key elements for the proof seems to appear as part of the focusing process. So even if Cabri is not directly used in the construction of the proof, it plays a very important role in determining the key elements to focus on. Therefore, the main impact of Cabri in the proving process concerns two issues: first, even if Cabri is not directly used

when proving the influence of the previous exploration is evident; second, the fact that Cabri allows focusing is extremely relevant for the actual proving phase, in that it allows theoretical elements to emerge.

To summarise, the research aims were:

- To investigate the development of the proving process (i.e. the construction of conjectures and proofs) within a dynamic geometry environment.
- To investigate the interactions taking place in the proving process.

The research findings suggest that the proving process develops as a *focusing process*, in which Cabri works as an environment in which students can dynamically experience and focus on properties and figures through ascending and descending processes from the spatio-graphical field to the theoretical field. Cabri also works as a shared communication space in which students can share their internal contexts and interact towards the production of conjectures and proofs.

Therefore, these findings do not suggest a hierarchy from empirical to deductive/theoretical proof, but that the key element of the proving process is a successful management of empirical and theoretical elements. Moving towards the theory does not mean abandoning the spatio-graphical field, but looking at it from another point of view. “Drawing is not to be abandoned at a definite epoch in the geometry course: practice and theory should advance hand in hand” (Godfrey, 1910, p.197). A cognitive unity (Boero, Garuti & Mariotti, 1996b) seems to be taking place between conjecturing and proving, which are part of the development of *one* focusing process, in which objects and statements are transformed and organised into conjectures and proofs.

### 10.2.1 The *focusing process* as a process of instrumentalisation

The explanatory framework describes proving as a *focusing process* in which Cabri allows the focusing process to happen thorough the shifts between ascending and descending processes. Obviously, this framework does not guarantee that the focusing process will lead all students to manage well the ascending and descending processes between spatio-graphical and theoretical field towards conjecturing and proving. The data have shown that there are cases in which this does not happen (see for example the cases of D&G and A&T, in which the focus on a particular Cabri configuration was an obstacle in the construction of the proof). Age, mathematical, cultural and classroom background, Cabri expertise, are variables which will influence the development of the proving process and the focusing on

---

different elements at different moments. Even if this study did not explicitly take into account these variables (which will need further investigation) and the sample used does not allow generalisation, some general observations can be made:

- (a) Students with considerable Cabri experience and average mathematical background (the case of V&M&E and B&T) seem to manage better the interaction with Cabri, showing a wide range of dragging modalities and a successful focusing process. They do not use paper. They are able to link the spatio-graphical and theoretical field by themselves in a productive way, which leads to the production of many conjectures and proofs.
- (b) Students with very little Cabri experience but with a strong mathematical background (the case of A&W) do not fully exploit the possibilities offered by the software. In general they show more controlled exploration in Cabri.
- (c) Students with very little Cabri experience and weak mathematical background (the case of D&G and A&T) usually experiment a lot with Cabri but do not always use it successfully. Conflicts may arise between results produced in the spatio-graphical field and possible theoretical explanations and the focusing process may lead to a wrong direction.

The framework of instrumentalisation (Verillion & Rabardel, 1995) as elaborated by Mariotti (2002) (presented in section 3.6), provides a theoretical justification for each of the behaviours (a), (b) and (c). The ways of focusing during the proving process depend on the way students make use of the tools available to them, i.e. the way they interact with Cabri (emergent or planned) and paper together with the ways they interact with each other through Cabri (synchronous or asynchronous). The instrumental approach distinguishes *artefact*, which is "the particular object with its intrinsic characteristics, designed and realised for the purpose of accomplishing a particular task" and *instrument*, that is "the artefact and the modalities of its use, as elaborated by a particular user" (Mariotti, 2002, p.702). Throughout the proving process the students construct different instruments out of the Cabri artefact, by developing schemes of use, which tell how to use it as a means of focusing on particular things. Cabri becomes an instrument of semiotic mediation (Mariotti, 2002) if a theoretical control is activated, as happens in the case of V&M&E, as discussed below.

In case (a) described above, the artefact Cabri is transformed by the students into an instrument which is appropriate to deal with the situation they are presented with. There is a theoretical control over Cabri, which is used as a discovery tool within ascending

processes, and is then re-interpreted and used as a validation tool or support for thinking within descending processes. This is the result of both mathematical and Cabri long term experience, which allow them to transform Cabri into an internally oriented tool (in the sense of Vygotsky (1978)). This is for example evident from the fact that in the case of V&M&E, the students often talk about dragging and the way they are using it, there is a control over what they are doing in Cabri and they understand well what Cabri can do and show.

In case (b), it seems that the artefact Cabri is never transformed into an instrument for students. It remains an artefact which is used occasionally but is not really taken on board by the students. The students prefer to use other tools (as for example paper and pencil) they are more used to and show a successful production of conjectures and proofs. Given their mathematical strength, it seems that these students are less eager to experiment with new tools they are not familiar with. (This behaviour can be observed with 'experts' at different levels).

In case (c) the process of instrumentalisation develops through different steps and the intervention of the teacher is needed in order to direct students towards the construction of the appropriate instrument which allows the evolution of the focusing process in the construction of conjectures and proofs. The artefact Cabri is first turned into an instrument based on a scheme of use that relies on a visual-perceptual-numerical interpretation of the software's feedback. This is not the instrument which serves to accomplish the goal of the problem situations. A new instrument needs to be constructed by the students, based on a theoretical way of 'reading' the Cabri figures. The role of the teacher is crucial in developing this new scheme of use (as we saw in the case of D&G and A&T) and provoking students to see the same figure from a different point of view and move from an ascending process to a descending process which leads them to conjecturing and finally proving.

From the above discussion, the role of the teacher emerges as important, showing that dynamic geometry per se does not guarantee a successful management of the relationship between the spatio-graphical field and the theoretical field, as shown in the case studies analysed. The teacher should act in 'transforming' the tool used by the students (Cabri) into a "semiotic mediator" (Mariotti, 2002) in the proving process so that a process of internalisation of the tool itself takes place and the artefact is then transformed into an appropriate instrument for the situation at stake.

---

### 10.3 IMPLICATIONS FOR TEACHERS

This study explored the ways in which students use Cabri and other tools (paper sketches) to solve open geometry problems and developed an explanatory framework to interpret the development of the proving process. The findings of this study highlight the importance of the process of *focusing* throughout the proving process: particular Cabri objects are progressively transformed into generic objects and descriptions of facts are transformed into general conjectures through the shifts between ascending and descending processes. This section will discuss the inputs for teaching practice which are suggested by the research findings; in particular it will address issues regarding how teachers may use Cabri in the classroom to support students' approach to proving.

The explanatory framework developed suggests a number of *tools for focusing* which account for behaviours observed in students when they are proving using a dynamic geometry software. These tools can be interpreted from a teaching perspective and become objects of teaching, as discussed below. First, it is important that teachers are aware of these tools and then they should be made explicit to students as well, so that they are introduced to a use of the tool (Cabri), which helps the focusing process, i.e. it is transformed into an appropriate instrument that is then internalised (Mariotti, 2002).

**Dragging.** The analysis shows that different dragging modalities are used with different purposes over the proving process (see 9.2.1). All of them may be useful and support the proving process if used with an appropriate aim and at an appropriate moment. For example we have seen that V&M&E show a wide range of dragging modalities used and they succeed in formulating general conjectures and proving them (see section 8.4). This suggests that there is a need to make these different dragging modalities explicit so that students are aware of them and have the possibility of choosing the one most suitable for the task they are dealing with. In fact, “students do not, in general, seem to know how to perform meaningful experiments” (Goldenberg, 1995, p.221). In particular, *lieu muet* dragging seems to be a quite complex and refined modality therefore not spontaneously used by many students. However it can be the key modality to make the transition to descending processes and link the spatio-graphical field with the theoretical field. For this reason, students should be made aware of this modality and the affordances it offers.

Dynamic geometry should not be treated as if it is merely a new interface to Euclidean construction. “Line segments that stretch and points that move relative to each other are not trivially the same objects that one treats in the familiar synthetic geometry, and this

suggests new styles of reasoning” (Goldenberg, 1995, p.220). It is important that teachers are aware of this fact and open to face new ways of reasoning students may show when working with dynamic geometry and the *Cabri-geometry* (Hölzl, 1996).

**Hiding and showing construction elements.** The possibility of hiding and showing elements in Cabri is a ‘new’ powerful tool of dynamic geometry software, because according to what is left visible the focus can shift to different elements. Again it is important that students are aware of this possibility and of how it can be exploited. Showing lines, together with dragging the figure, will help the students to keep in mind the properties of the construction. Hiding some elements may be useful when wanting to focus on some particular configuration (for example to avoid what happened to D&G, when they had too many lines visible and could not identify which quadrilaterals they had to consider - see section 8.2.2).

**Sketching on paper.** From the analysis it emerged that there are moments in which students felt the need to do sketching on paper, either when they do not have the possibility of using the mouse or when they are focused on some particular configuration and they want to prove it. It is important that teachers make clear that the technology does not substitute traditional tools such as paper but on the contrary both tools afford different things. For example, doing sketches on paper may be faster and therefore more appropriate when wanting to focus on some particular conjecture and add elements to the proof.

**Student-student interactions.** The interaction between students has also proven a powerful element in the construction of conjectures and proofs as a way of telling a new story (see section 9.2.6). The fact of working in pairs (or groups) positively affected the development of the proving process. This suggests that the modality of working in the classroom when using a technological tool is important and that making students interact with each other is a potential tool to support the proving process. A question may be asked in what sense student-student interaction may become a teaching object. A study from Mercer, Wegerif & Dawes (1999) has shown that “using a specially-designed programme of teacher-led and group-based activities, teachers can increase the amount of exploratory talk used by children working together in the classroom” (Mercer et al., 1999), where

*Exploratory talk* is that in which partners engage critically but constructively with each other's ideas. Statements and suggestions are sought and offered for joint consideration. These may be challenged and counter-challenged, but challenges are justified and alternative hypotheses are offered. In exploratory talk, *knowledge is made publicly accountable and reasoning is visible in the talk.* (Mercer et al., 1999, p.97)



---

Besides Cabri, another important element of the study was the choice of problems. The project has shown that the problems given to the students and the situation the students are required to work in are fundamental, together with the software chosen. Open problems have revealed a key component of the focusing process, in that they provide an open situation in which the focusing process may develop and allow theoretical elements to emerge through the work with Cabri. The implication of this result is that careful planning by the teachers of what to do with Cabri and how to do it is needed in order to make sensible and successful use of the software.

The idea of the focusing process suggests that the work with Cabri may be a potent tool for building effectively on geometrical intuition, by linking it more directly with geometrical theory. This would entail developing pedagogical methods that mean that a deductive and an intuitive approach are mutually reinforcing when solving geometrical problems (Jones, 1998), as for example by using tools such as Cabri. To conclude, what emerges from the research is the importance of the use of Cabri as a support to introduce students to proving in geometry but at the same time the fact that this technological tool must be integrated into more traditional tools (as paper), recognising different potentialities of different tools and must be used in an appropriate context (that of open problems for example) to be carefully chosen or designed by teachers (and/or curriculum developers).

#### **10.4 IMPLICATIONS FOR FURTHER RESEARCH**

The analysis of the large amount of data I dealt with in this study was extremely rich. The qualitative approach to the analysis allowed the data to speak and at the end of the analytical process, which in a sense went on until the very end of the writing up of this thesis, many issues still remain open and could lead to further investigation. This section explores what still needs to be done with respect to the analytical and explanatory framework developed in this study.

**Working with an English and an Italian context.** It was not possible to make a comparison of the transcripts according to the different countries (Italy and UK) the students belonged to, as planned at the beginning of the project. The amount of information gathered for each school, classroom and student was not sufficient to be able to investigate results which depend on students' backgrounds. However, working within the perspective of socio-cultural research, I am aware of the implications of students' backgrounds (at the level of the classroom culture and experience) on their behaviour when solving the given problems. Further research is needed in order to explore the influence of these factors upon

students' proving processes. As discussed in section 10.2.1, some general observations about different processes of instrumentalisation according to students' mathematical background and Cabri expertise were identified. A larger sample would be needed in order to validate these preliminary observations. Moreover more data concerning students' mathematical background should be gathered through other research methods, as for example interviews with teachers and students.

**Types of statements and language.** Further research needs to be carried out on the function of language in the development of the proving process and in the progressive *focusing process*. In fact language has a very important role in the change of status of objects and statements, as shown by the analysis (see section 9.2.4). Taking on board the analysis of the language functions done by Radford (1999) in an algebraic context, it would be interesting to see how these functions work in a geometrical context, and in particular in a context involving the use of dynamic geometry software. This kind of analysis should provide more evidence and support for the importance of ascending-descending shifts throughout the proving process, in order for the progressive focusing to happen and to lead students to the production of conjectures and proofs. Another way of analysing language which could be pursued is through the analysis done using a concordance software (Wegerif & Mercer, 1997). This allows counting the incidence of particular words in the transcripts and associating them to particular phases of the process. "The incidence of exploratory talk was associated with the more frequent use of certain linguistic features. [...] Longer utterances seemed a particularly effective indicator of exploratory talk." (Mercer et al., 1999, p.105).

**Emergent and planned interaction.** This category accounts for the type of interaction students have with Cabri, and as such it is defined by all actions students do in Cabri. This research has taken into account only two of the available tools within Cabri (dragging and hiding/showing construction lines). An interesting follow-up would be to look at the use of other Cabri tools, as for example the use of measures<sup>1</sup>, in the interaction of students with Cabri in order to single out the contribution of different tools to the way students make use of Cabri in the proving process. Another strand of research could investigate the interactions between students and Cabri within other contexts (e.g. construction problems, analytic geometry). This could then be compared with research looking at the same interactions with other software, in order to see if there is any specificity in each particular

---

software, that can be taken on board more or less by students and foster the construction of a particular type of *instrument*. A comparison with student' interactions with paper and pencil would also be interesting.

**Role of the teacher.** The role of the teacher with respect to the development of the proving process for students working with Cabri needs to be studied in more detail. In particular, the role of the teacher in the interaction with students and with the software and in the process of building a communication space is to be investigated. Can Cabri become a shared space of communication and interaction between students and teacher? Other possibilities of creating a shared space of communication to foster the construction of common knowledge and a productive interaction between students should be investigated. For example the use of electronic whiteboards, that provide a larger space available to the whole classroom for interaction. A well structured comparison with paper and pencil environment, in order to see the different *affordances* of technological and non technological environments, would be very useful in order to be able to see when each tool can appropriately be used.

---

<sup>1</sup> Some research has been carried out already, see Olivero & Robutti (2001; 2002).

---

**REFERENCES**

- AAVV. (1991). Piani di studio della scuola secondaria superiore e programmi dei primi due anni. Le proposte della commissione Brocca. *Studi e documenti degli Annali della Pubblica Istruzione*, 56.
- AAVV. (2000). *Principles and Standards for School Mathematics, NCTM, Standards 2000*, [web]. Available: <http://standards.nctm.org/> [2001, 14th September].
- Abrantes, P. (2001). Revisiting the goals and the nature of mathematics for all in the context of a national curriculum. In M. van den Heuvel-Panhuizen (Ed.), *Proceedings of the 25th Conference of the International Group for the Psychology of Mathematics Education* (Vol. 1, pp. 25-40). Utrecht, The Netherlands.
- Alibert, D., & Thomas, M. (1991). Research on mathematical proof. In D. Tall (Ed.), *Advanced mathematical thinking* (pp. 215-230). Washington: Kluwer Academic Publishers.
- Almeida, D. (1996). *Justifying and proving in the mathematics classroom*. Philosophy of Mathematics Education Newsletter (9). Available: <http://www.ex.ac.uk/~PERnest/pome/pompert8.htm> [2002, 3rd October].
- Arnaud, A., & Nicole, P. (1662). *La logique ou l'art de penser*. Paris: Gallimard.
- Arsac, G. (1992). Initiation au raisonnement déductif au collège (pp. 105-120). Lyon: Presses universitaires de Lyon.
- Arsac, G. (1999a). *Les limites d'un enseignement déductif de la Géométrie*. Paper presented at the Winter School in the Epistemology of Mathematics for Didactics, Levico (Italy).
- Arsac, G. (1999b). Variations et variables de la démonstration géométriques. *Recherches en Didactique des Mathématiques*, 19(3), 357-390.
- Arsac, G., Germain, G., & Mante, M. (1988). *Problème Ouvert et Situation - Problème*. Academie de Lyon: IREM.
- Artigue, M. (1997). Le logiciel DERIVE comme révélateur de phénomènes didactiques liés à l'utilisation d'environnements informatiques pour l'apprentissage. *Educational Studies in Mathematics*, 33(2), 133-169.
- Artigue, M. (2001). *Learning mathematics in a CAS environment: the genesis of a reflection about instrumentation and the dialectics between technical and conceptual work*. Paper presented at the 2° CAME Symposium, Utrecht, The Netherlands.

- 
- Arzarello, F. (2000). Inside and Outside: Spaces, Times and Language in Proof Production. In T. Nakahara & M. Koyama (Eds.), *Proceedings of the 24th Conference of the International Group for the Psychology of Mathematics Education* (Vol. 1, pp. 23-38). Hiroshima, Japan.
- Arzarello, F., & Bartolini Bussi, M. (1998). Italian Trends of Research in Mathematics Education: a National Case Study in the International Perspective. In J. Kilpatrick & A. Sierpiska (Eds.), *What is Research in Mathematics Education and What Are Its Results?* (pp. 243-262). Washington: Kluwer Academic Publishers.
- Arzarello, F., Gallino, G., Micheletti, C., Olivero, F., Paola, D., & Robutti, O. (1998a). Dragging in Cabri and modalities of transition from conjectures to proofs in geometry. In A. Olivier & K. Newstead (Eds.), *Proceedings of the 22nd Conference of the International Group for the Psychology of Mathematics Education* (Vol. 2, pp. 32-39). Stellenbosh, South Africa.
- Arzarello, F., Micheletti, C., Olivero, F., Paola, D., & Robutti, O. (1998b). A model for analysing the transition to formal proofs in geometry. In A. Olivier & K. Newstead (Eds.), *Proceedings of the 22nd Conference of the International Group for the Psychology of Mathematics Education* (Vol. 2, pp. 24-31). Stellenbosh, South Africa.
- Arzarello, F., Olivero, F., Paola, D., & Robutti, O. (1999). Dalle congetture alle dimostrazioni. Una possibile continuità cognitiva. *L'insegnamento della matematica e delle scienze integrate*, 22B(3), 209-233.
- Atkinson, J. M., & Heritage, J. C. (Eds.). (1984). *Structures of Social Action*. Cambridge: Cambridge University Press.
- Babai, L. (1992). Transparent proofs. *Focus*, 12(3), 1-2.
- Bachelard, G. (1938). *La formation de l'esprit scientifique: contribution à une psychanalyse de la connaissance objective*. Paris: Vrin.
- Balacheff, N. (1982). Preuve et démonstrations en mathématique au collège. *Recherches en Didactique des Mathématiques*, 3(3), 261-304.
- Balacheff, N. (1987). Processus de preuve et situation de validation. *Educational Studies in Mathematics*, 18, 147-176.
- Balacheff, N. (1988). Aspects of proof in pupils' practice of school mathematics. In D. Pimm (Ed.), *Mathematics, Teachers and Children* (pp. 216-238). London: Hodder and Soughton.
- Balacheff, N. (1998). Construction of Meaning and Teacher Control of Learning. In T. D & J. D.C. (Eds.), *Information and communication technology in school mathematics*: Chapman & Hall.
- Balacheff, N. (1999). Apprendre la preuve. In S. J & S. J. J (Eds.), *Le concept de preuve à la lumière de l'intelligence artificielle* (pp. 197-236). Paris: PUF.
- Barbin, E. (1988). La dimostrazione matematica: significati epistemologici e questioni didattiche. *L'insegnamento della Matematica e delle Scienze Integrate*, 17B, 212-246.
- Barnard, T., Somson, A., Tahta, D., MacKernan, J., Pope, S., Reod, D., Haworth, A., Hewitt, D., Ball, D., & Anderson, J. (1996). Teaching proof. *Mathematics Teaching*, 155, 6-39.
- Bartolini Bussi, M. (1993). Geometrical proofs and mathematical machines. An exploratory study, *Proceedings of the 17th International Conference on the Psychology of Mathematics Education* (Vol. 2, pp. 97-104). Tsukuba, Japan.
- Bartolini Bussi, M. (1996). Mathematical Discussion and Perspective Drawing in Primary School. *Educational Studies in Mathematics*, 31(1-2), 11-41.

- Bartolini Bussi, M. (2000). *Early approach to mathematical ideas related to proof making*. Paper presented at the ICME9, TSG12: Proof and Proving in Mathematics Education, Tokyo, Japan.
- Bartolini Bussi, M., & Mariotti, M. A. (1998). From drawing to construction: teacher's mediation within the Cabri environment. In A. Olivier & K. Newstead (Eds.), *Proceedings of the 22nd Conference of the International Group for the Psychology of Mathematics Education* (Vol. 3, pp. 247-254). Stellenbosh, South Africa.
- Baulac, Y., Bellemain, F., & Laborde, J. M. (1988). *Cabri-Géomètre, un logiciel d'aide à l'apprentissage de la géométrie. Logiciel et manuel d'utilisation*. Paris: Cedic-Nathan.
- Bennet, S. N. (1991). Cooperative learning in classrooms: processes and outcomes. *Journal of Child Psychology and Psychiatry*, 32, 581-594.
- Blum, M. (1986). How to prove a theorem so no one else can claim it, *Proceedings of the International Congress of the Mathematician* (pp. 1444-1451).
- Boero, P. (2000). Can research in mathematics education be useful for the teaching and learning of mathematics in school? and how? In T. Nakahara & M. Koyama (Eds.), *Proceedings of the 24th Conference of the International Group for the Psychology of Mathematics Education* (Vol. 1, pp. 76-79). Hiroshima, Japan.
- Boero, P., Dapueto, C., Ferrari, P., Ferrero, E., Garuti, R., Lemut, E., Parenti, L., & Scali, E. (1995). Aspects of the Mathematics-Culture Relationship in Mathematics Teaching-Learning in Compulsory School, *Proceedings of the 19th Conference of the International Group for the Psychology of Mathematics Education* (Vol. 1, pp. 151-166). Recife, Brasil.
- Boero, P., Garuti, R., & Lemut, E. (1999). About the generation of conditionality of statements and its link with proving. In O. Zaslavsky (Ed.), *Proceedings of the 23rd Conference of the International Group for the Psychology of Mathematics Education* (Vol. 2, pp. 137-144). Haifa, Israel.
- Boero, P., Garuti, R., & Mariotti, M. A. (1996a). Challenging the traditional school approach to theorems. In L. Puig & A. Gutierrez (Eds.), *Proceedings of the 20th Conference of the International Group for the Psychology of Mathematics Education* (Vol. 2, pp. 113-120). Valencia, Spain.
- Boero, P., Garuti, R., & Mariotti, M. A. (1996b). Some dynamic mental processes underlying producing and proving conjectures. In L. Puig & A. Gutierrez (Eds.), *Proceedings of the 20th Conference of the International Group for the Psychology of Mathematics Education* (Vol. 2, pp. 121-128). Valencia, Spain.
- Bogdan, R. C., & Biklen, S. K. (1998). *Qualitative Research in Education*. Boston London: Allyn and Bacon, Inc.
- Bolite Frant, J., & Rabello de Castro, M. (2000). *Proofs in Geometry: different concepts build upon very different cognitive mechanisms*. Paper presented at the ICME9, TSG12: Proof and Proving in Mathematics Education, Tokyo, Japan.
- Brousseau, G. (1988). Le contract didactique: le milieu. *Recherches en didactique des mathématiques*, 9(3), 309-336.
- Brousseau, G., & Balacheff, N. (1997). *Theory of didactical situations in mathematics: didactique des mathématiques, 1970-1990*. Dordrecht: Kluwer Academic Publishers.
- Brown, A., & Dowling, P. (1998). *Doing Research/ Reading Research. A mode of Interrogation for Education*. London: The Falmer Press.

- 
- Bruckheimer, M., & Arcavi, A. (2001). A herrick among mathematicians or dynamic geometry as an aid to proof. *International Journal of Computers for Mathematical Learning*, 6, 113-126.
- Bruner, J. (1996). *The culture of education*. Cambridge, MA: Harvard University Press.
- Cellucci, C. (1998). *Le ragioni della logica*. Bari: Laterza.
- Chazan, D. (1993). High school geometry students' justification for their views of empirical evidence and mathematical proof. *Educational Studies in Mathematics*, 24, 359-387.
- Cifarelli, V. (2000). Mental projection in mathematical problem solving: abductive inference and schemes of action in the evolution of mathematical knowledge. In T. Nakahara & M. Koyama (Eds.), *Proceedings of the 24th Conference of the International Group for the Psychology of Mathematics Education* (Vol. 2, pp. 185-192). Hiroshima, Japan.
- Clark, H., & Schaefer, E. (1989). Contributing to discourse. *Cognitive Science*, 13, 259-294.
- CREM. (1995). *Les Mathématiques de la maternelle jusqu'à 18 ans. Essai d'élaboration d'un cadre global pour l'enseignement des mathématiques* (Grugnetti, Lucia & Villani, Vinicio, Trans.). Bologna: Pitagora Editrice.
- Crook, C. (1994). *Computers and the collaborative experience of learning*. London: Routledge.
- Department for Education. (1995). *Mathematics in the National Curriculum*. London: HMSO.
- deVilliers, M. (1990). The role and function of proof in mathematics. *Pythagoras*(24), 17-24.
- deVilliers, M. (1998). An Alternative Approach to Proof in Dynamic Geometry. In R. Lehrer & D. Chazan (Eds.), *Designing learning environments for developing understanding of geometry and space* (pp. 369-393). London: Lawrence Erlbaum Associates.
- Douek, N. (1999). Argumentative aspects of proving: analysis of some undergraduate mathematics students' performances. In O. Zaslavsky (Ed.), *Proceedings of the 23rd Conference of the International Group for the Psychology of Mathematics Education* (Vol. 2, pp. 273-280). Haifa, Israel.
- Dreyfus, T. (1999). Why Johnny can't prove. *Educational Studies in Mathematics*, 38(1-3), 85-109.
- Dreyfus, T., & Hadas, N. (1996). Proof as answer to the question why. *Zentralblatt für Didaktik der Mathematik*, 28(1), 1-5.
- Duval, R. (1991). Structure du raisonnement deductif et apprentissage de la démonstration. *Educational Studies in Mathematics*, 22, 233-261.
- Duval, R. (1996). Argomentare, dimostrare, spiegare: continuità o rottura cognitiva? *La matematica e la sua didattica*, 2, 130-152.
- Eisenhardt, M. K. (2002). Building theories from case study research. In A. Huberman & M. Miles (Eds.), *The qualitative researcher's companion* (pp. 5-36). Thousand Oaks: Sage Publications.
- Epp, S. (1994). The role of proof in problem solving. In A. Schoenfeld (Ed.), *Mathematical Thinking and Problem Solving* (pp. 257-269). Hillsdale, NJ: Lawrence Erlbaum Associates.
- Epstein, D., & Levy, S. (1995). Experimentation and proof in mathematics. *Notices of the American Mathematical Society*, 42(6), 670-674.
- Ernest, P. (1991). *The philosophy of mathematics education*. London: Falmer Press.
- Fujita, T., & Jones, K. (2002). The bridge between practical and deductive geometry: developing the 'geometrical eye'. In A. Cockburn & E. Nardi (Eds.), *Proceedings of the 26th Conference of the International Group for the Psychology of Mathematics Education* (Vol. 2, pp. 384-391). Norwich, UK.

- Furinghetti, F., Olivero, F., & Paola, D. (2001). Students approaching proof through conjectures: snapshots in a classroom. *International journal of Mathematical Education in Science and Technology*, 32(3), 319-335.
- Garuti, R., Boero, P., & Lemut, E. (1998). Cognitive unity of theorems and difficulty of proof. In A. Olivier & K. Newstead (Eds.), *Proceedings of the 22nd Conference of the International Group for the Psychology of Mathematics Education* (Vol. 2, pp. 345-352). Stellenbosh, South Africa.
- Gibson, J. J. (1979). *The ecological approach to visual perception*. Boston: Houghton Mifflin.
- Glaser, B. G., & Strauss, A. L. (1967). *The discovery of grounded theory strategies for qualitative research*. Chicago: Aldine.
- Godfrey, C. (1910). The Board of Education Circular on the Teaching of Geometry. Mathematical Association. *Mathematical Gazette*, 5, 195-200.
- Godino, J. D., & Recio, A. M. (1997). Meaning of proofs in mathematics education, *Proceedings of the 21st Conference of the International Group for the Psychology of Mathematics Education* (Vol. 2, pp. 313-320). Lahti, Finland.
- Gold, R. (1958). Role in sociological field observations. *Social Forces*, 36, 217-223.
- Goldenberg, E., & Hazzan, O. (1995). Proving: Relationships to Construction, Visualization and Language .
- Goldenberg, E. P. (1995). Ruminations about dynamic imagery (and a strong plea for research). In R. Sutherland & J. Mason (Eds.), *Exploiting Mental Imagery with Computers in Mathematics Education* (pp. 202-224). Berlin: Springer-Verlag.
- Goldenberg, E. P., & Cuoco, A. (1998). What is dynamic geometry. In R. Lehrer & D. Chazan (Eds.), *Designing learning environments for developing understanding of geometry and space* . Hillsdale, NJ: Lawrence Erlbaum Associates.
- Griesel, H., & Steiner, H. G. (1992). The Organization of Didactics of Mathematics as a Professional Field. *Zentralblatt für Didaktik der Mathematik*, 24(7), 287-295.
- Hadas, N., Hershkowitz, R., & Schwartz, B. (2000). The role of contradiction and uncertainty in promoting the need to prove in dynamic geometry environments. *Educational Studies in Mathematics*, 44, 127-150.
- Hanna, G. (1989). More than formal proof. *For the Learning of Mathematics*, 9(1), 20-23.
- Hanna, G. (1995). Challenges to the importance of proof. *For the Learning of Mathematics*, 15(3), 42-49.
- Hanna, G. (1996). The ongoing value of proof. In L. Puig & A. Gutierrez (Eds.), *Proceedings of the 20th Conference of the International Group for the Psychology of Mathematics Education* (Vol. 1, pp. 21-33). Valencia, Spain.
- Hanna, G. (1998). Proof as explanation in geometry. *Focus on learning problems in mathematics*, 20(2&3), 4-13.
- Hanna, G. (2000). A critical examination of three factors in the decline of proof. *Interchange*, 31(1), 21-33.
- Harel, G. (1998). Two dual assertions: the first on learning and the second on teaching (or vice versa). *The American Mathematical Monthly*, 105, 497-507.
- Harel, G., & Sowder, L. (1996). Classifying processes of proving. In L. Puig & A. Gutierrez (Eds.), *Proceedings of the 20th Conference of the International Group for the Psychology of Mathematical Education* (Vol. 3, pp. 59-66). Valencia, Spain.
- Harel, G., & Sowder, L. (1998). Students' proof schemes. In E. Dubinsky, A. Schoenfeld, & J. Kaput (Eds.), *Research on Collegiate Mathematics Education III* (Vol. 7, pp. 234-282). American Mathematical Society.



- 
- Healy, L. (2000a). *Connections between the empirical and the theoretical? Some considerations of students' interactions with examples in the proving process*. Paper presented at the ICME9, TSG12: Proof and Proving in Mathematics Education, Tokyo, Japan.
- Healy, L. (2000b). Identifying and explaining geometrical relationship: interactions with robust and soft Cabri constructions. In T. Nakahara & M. Koyama (Eds.), *Proceedings of the 24th Conference of the International Group for the Psychology of Mathematics Education* (Vol. 1, pp. 103-117). Hiroshima, Japan.
- Healy, L., Hölzl, R., Hoyles, C., & Noss, R. (1994a). Cabri constructions. *Micromath*, 10(2), 13-16.
- Healy, L., Hölzl, R., Hoyles, C., & Noss, R. (1994b). Messing up. *Micromath*, 10(1), 14-16.
- Healy, L., & Hoyles, C. (1998a). *Justifying and proving in school mathematics* (Technical Report on the Nationwide Survey). London: Institute of Education, University of London.
- Healy, L., & Hoyles, C. (1998b). Students' Performance in Proving: Competence or Curriculum? In I. Schwank (Ed.), *Proceedings of the First Conference of the European Society for Research in Mathematics Education* (Vol. 1, pp. 153-167).
- Healy, L., Pozzi, S., & Hoyles, C. (1995). Making Sense of Groups, Computers and Mathematics. *Cognition and Instruction*, 13(4), 505-523.
- Hersh, R. (1993). Proving is convincing and explaining. *Educational Studies in Mathematics*, 24, 389-399.
- Hölzl, R. (1995). Between drawing and figure. In R. Sutherland & J. Mason (Eds.), *Exploiting Mental Imagery with Computers in Mathematical Education* (pp. 117-124). Berlin: Springer-Verlag.
- Hölzl, R. (1996). How does 'dragging' affect the learning of geometry. *International Journal of Computers for Mathematical Learning*, 1, 169-187.
- Hölzl, R. (2001). Using dynamic geometry software to add contrast to geometric situations - a case study. *International Journal of Computers for Mathematical Learning*, 6, 63-86.
- Horgan, J. (1993). The death of proof. *The Scientific American*, 269(4), 74-103.
- Hoyles, C. (1993). Microworlds/Schoolworlds: the Transformation of an Innovation. In C. Keitel & K. Ruthven (Eds.), *Learning from Computers: Mathematics Education and Technology. NATO ASI Series F 121: Computer and Systems Sciences* (pp. 1-17). Berlin: Springer-Verlag.
- Hoyles, C. (1997). The Curricular Shaping of Students' Approaches to Proof. *For the Learning of Mathematics*, 17(1), 7-16.
- Hoyles, C. (1998). A culture of proving in school mathematics? In J. D. Tinsley & D. C. Johnson (Eds.), *Information and Communications Technologies in School Mathematics* (pp. 169-181). London: Chapman & Hall.
- Hoyles, C., & Healy, L. (1999). Linking informal argumentation with formal proof through computer-integrated teaching experiments. In O. Zaslavsky (Ed.), *Proceedings of the 23rd Conference of the International Group for the Psychology of Mathematics Education* (Vol. 3, pp. 105-112). Haifa, Israel.
- Hoyles, C., & Jones, K. (1998). Proof in dynamic geometry contexts. In C. Mammanna & V. Villani (Eds.), *Perspectives on the Teaching of Geometry for the 21st Century* (pp. 121-128). Dordrecht: Kluwer Academic Publishers.
- Hoyles, C., Sutherland, R., & Healy, L. (1991). Children talking in computer environments: New insights into the role of discussion in mathematics learning. In K. Durkin & B. Shire (Eds.), *Language in Mathematical Education Research and Practice* (pp. 162-175). Oxford: Open University Press.

- Jaffe, A., & Quinn, F. (1993). Theoretical mathematics: Towards a cultural synthesis of mathematics and theoretical physics. *Bulletin of the American Mathematical Society*, 29(1), 1-13.
- Jones, K. (1998). Deductive and intuitive approaches to solving geometrical problems. In C. Mammana & V. Villani (Eds.), *Perspectives on the Teaching of Geometry for the 21st Century. An ICMI Study*. (pp. 78-83). Dordrecht: Kluwer.
- Jones, K. (2000). Providing a foundation for deductive reasoning: students' interpretations when using dynamic geometry software and their evolving mathematical explanations. *Educational Studies in Mathematics*, 44, 55-85.
- Kieran, C., & Dreyfus, Y. (1998). Collaborative versus individual problem solving: entering another's universe of thought. In A. Olivier & K. Newstead (Eds.), *Proceedings of the 22nd Conference of the International Group for the Psychology of Mathematics Education* (Vol. 3, pp. 112-119). Stellenbosh, South Africa.
- Kilpatrick, J. (1987). Problem Formulating: where do good problems come from? In A. Schoenfeld (Ed.), *Cognitive science and mathematics education* (pp. 123-147). Hillsdale, NJ: Lawrence Erlbaum Associates.
- Kline, M. (1973). *Why Johnny Can't Add*. New York: Random House.
- Knuth, E. (2000). *The rebirth of proof in school mathematics in the United States?* (International Newsletter on the Teaching and Learning of Mathematical Proof). Available: <http://www-didactique.imag.fr/preuve/Newsletter/000506Theme/000506ThemeUK.html> [2001, 20-11-2001].
- Küchemann, D., & Hoyles, C. (2001). Investigating factors that influence students' mathematical reasoning. In M. van den Heuvel-Panhuizen (Ed.), *Proceedings of the 25th Conference of the International Group for the Psychology of Mathematics Education* (Vol. 3, pp. 257-264). Utrecht, The Netherlands.
- Laborde, C. (1993). The computer as part of the learning environment: the case of geometry. In C. Keitel & K. Ruthven (Eds.), *Learning from Computers: Mathematics Education and Technology* (pp. 48-67). Berlin: Springer-Verlag.
- Laborde, C. (1995). Designing Tasks for Learning Geometry in a Computer-Based Environment. The Case of Cabri-Géomètre. In L. Burton & B. Jaworski (Eds.), *Technology in Mathematics Teaching: a bridge between teaching and learning* (pp. 35-68): Chartwell-Bratt.
- Laborde, C. (1997). Incontro dello straordinario e dell'ordinario nell'insegnamento: l'integrazione di Cabri-Géomètre nell'insegnamento della geometria. In B. D'Amore (Ed.), *Didattica della matematica e realtà scolastica*. Bologna: Pitagora Editrice.
- Laborde, C. (1998). Relationship between the spatial and theoretical in geometry: the role of computer dynamic representations in problem solving. In J. D. Tinsley & D. C. Johnson (Eds.), *Information and Communications Technologies in School Mathematics* (pp. 183-195). London: Chapman & Hall.
- Laborde, C. (2000). Dynamic Geometry Environments as a Source of Rich Learning Contexts. *Educational Studies in Mathematics*, 44(1/2), 151-161.
- Laborde, C. (2001). Integration of technology in the design of geometry tasks with Cabri-geometry. *International Journal of Computers for Mathematical Learning*, 6, 283-317.
- Laborde, C. (in print). The hidden role of diagrams in pupils' construction of meaning in geometry, *Bacomet IV*.

- 
- Lagrange, J. B. (1999). Learning pre-calculus with complex calculators: mediation and instrumental genesis. In O. Zaslavsky (Ed.), *Proceedings of the 23rd Conference of the International Group for the Psychology of Mathematics Education* (Vol. 3, pp. 193-200). Haifa, Israel.
- Lagrange, J. B., Artigue, M., Laborde, C., & Trouche, L. (2001). A meta study on IC technologies in education. Towards a multidimensional framework to tackle their integration. In M. van den Heuvel-Panhuizen (Ed.), *Proceedings of the 25th Conference of the International Group for the Psychology of Mathematics Education* (Vol. 1, pp. 111-122). Utrecht, The Netherlands.
- Lolli, G. (1999). *Truths and Proofs*. Paper presented at the Winter School in the Epistemology of Mathematics for Didactics, Levico Terme (Italy).
- Magnani, L. (1997). *Ingegnerie della conoscenza*. Milano: Marcos y Marcos.
- Maher, C., & Kiczek, R. D. (2000). *Long term building of mathematical ideas related to proof making*. Paper presented at the ICME9, TSG12: Proof and Proving in Mathematics Education, Tokyo, Japan.
- Malara, N. A. (1998). Didattica della Matematica: il caso italiano, *Proceedings of the International Colloquium Fachdidaktik als Wissenschaft und Forschungsfeld in der Schweiz*.
- Mariotti, M. A. (1996). Costruzioni in geometria: alcune riflessioni. *L'insegnamento della matematica e delle scienze integrate*, 19B(3), 261-287.
- Mariotti, M. A. (1998). Introduzione alla dimostrazione all'inizio della scuola secondaria superiore. *L'insegnamento della matematica e delle scienze integrate*, 21B, 209-252.
- Mariotti, M. A. (2002). Influence of technologies advances on students' maths learning. In L. English, M. Bartolini Bussi, G. Jones, R. Lesh, & D. Tirosh (Eds.), *Handbook of International Research in Mathematics Education* (pp. 695-721): Lawrence Erlbaum Associates.
- Mariotti, M. A., Bartolini Bussi, M., Boero, P., Ferri, F., & Garuti, R. (1997). Approaching geometry theorems in contexts: from history and epistemology to cognition, *Proceedings of the 21st Conference of the International Group for the Psychology of Mathematics Education* (Vol. 1, pp. 180-195). Lathi, Finland.
- Marrades, R., & Gutierrez, A. (2000). Proofs produced by secondary school students learning geometry in a dynamic computer environment. *Educational Studies in Mathematics*, 44, 87-125.
- Martin, W. G., & Harel, G. (1989). Proof frames of preservice elementary teachers. *Journal for Research in Mathematics Education*, 20(1), 41-51.
- Mason, J. (1991). Questions about geometry. In D. Pimm & E. Love (Eds.), *Teaching and learning school mathematics* (pp. 77-90). London: Hodder and Stoughton.
- Mason, J., Burton, L., & Stacey, K. (Eds.). (1985). *Thinking mathematically*. Wokingham: Addison-Wesley.
- Mason, J., & Heal, B. (1995). Mathematical Screen Metaphors. In R. Sutherland & J. Mason (Eds.), *Exploiting Mental Imagery with Computers in Mathematical Education* (pp. 291-308). Berlin: Springer-Verlag.
- Mazur, B. (1997). Conjecture. *Synthese*, 11(1), 197-210.
- Mercer, N., Wegerif, R., & Dawes, L. (1999). Children's Talk and the Development of Reasoning in the Classroom. *British Educational Research Journal*, 25(1), 95-111.
- Miles, M., & Huberman, A. (1994). *Qualitative Data Analysis*. London: Sage.
- Miyazaki, M. (2000a). Levels of proof in lower secondary school mathematics. *Educational Studies in Mathematics*, 41(1), 47-68.

- Miyazaki, M. (2000b). What are essential to apply the "discovery" function of proof in lower secondary mathematics? In T. Nakahara & M. Koyama (Eds.), *Proceedings of the 24th Conference of the International Group for the Psychology of Mathematics Education* (Vol. 4, pp. 1-8). Hiroshima, Japan.
- Mogetta, C. (2001). Argumentative processes in problem solving situations: the mediation of tools. In M. van den Heuvel-Panhuizen (Ed.), *Proceedings of the 25th Conference of the International Group for the Psychology of Mathematics Education* (Vol. 3, pp. 375-382). Utrecht, The Netherlands.
- Mogetta, C., Olivero, F., & Jones, K. (1999). Providing the Motivation to Prove in a Dynamic Geometry Environment, *Proceedings of the British Society for Research into Learning Mathematics, St Martin's University College* (pp. 91-96). Lancaster, UK.
- Moore, R. C. (1994). Making the transition to formal proof. *Educational Studies in Mathematics*, 27, 249-276.
- Morgan, C. (2001). Mathematics and human activity: representation in mathematical writing. In C. Morgan & K. Jones (Eds.), *Research in Mathematics Education*. London, UK.
- Movshowitz Hadar, N. (1988). Stimulating presentations of theorems followed by responsive proofs. *For the Learning of Mathematics*, 8(2), 12-19.
- National Council of Teachers of Mathematics. (1989). *Curriculum and evaluation standards for school mathematics*. Reston, VA: Commission on Standards for School Mathematics.
- National Council of Teachers of Mathematics. (1991). *Professional Standards for Teaching Mathematics*. Reston, VA: Commission on Standards for School Mathematics.
- Noss, R. (1994). Structure and ideology in the mathematics curriculum. *For the Learning of Mathematics*, 14(1), 2-10.
- Noss, R. (1995). Reclaiming the Mathematics Curriculum. *Mathematics in School*, 24(3), 4-5.
- Noss, R., & Hoyles, C. (1996). *Windows on Mathematical Meanings. Learning Cultures and Computers*. Boston: Kluwer Academic Publishers.
- Nunez, R. E. (2000). Mathematical Idea Analysis: what embodied cognitive science can say about the human nature of mathematics. In T. Nakahara & M. Koyama (Eds.), *Proceedings of the 24th Conference of the International Group for the Psychology of Mathematics Education* (Vol. 1, pp. 3-22). Hiroshima, Japan.
- Olivero, F. (1998). *Un percorso didattico dalla congettura alla dimostrazione in geometria*. Unpublished degree thesis, University of Turin, Turin (Italy).
- Olivero, F. (1999). Cabri-géomètre as a mediator in the process of transition to proofs in open geometric situations. In W. Maull & J. Sharp (Eds.), *Proceedings of the 4th International Conference on Technology in Mathematics Teaching (CD-ROM)*. Plymouth, UK.
- Olivero, F. (2001). Conjecturing in open geometric situations in a dynamic geometry environment: an exploratory classroom experiment. In C. Morgan & K. Jones (Eds.), *Research in Mathematics Education* (Vol. 3, pp. 229-246). London, UK.
- Olivero, F., & Robutti, O. (2001). Measuring in Cabri as a bridge between perception and theory. In M. v. d. Heuvel-Panhuizen (Ed.), *Proceedings of the 25th Conference* (Vol. 4, pp. 9-16). Utrecht, The Netherlands.
- Olivero, F., & Robutti, O. (2002). An exploratory study of students' measurement activity in a dynamic geometry environment, *Proceedings of CERME 2* (Vol. 1, pp. 215-226). Mariánské Lázně, CZ.
- Papert, S. (1980). *Mindstorms. Children, computers and powerful ideas*. New York: Basic Books.
- Papert, S. (1992). *The children's machine*. New York: Basic Books.

- 
- Pea, R. D. (1987). Cognitive Technologies for Mathematics Education. In A. H. Schoenfeld (Ed.), *Cognitive science and mathematics education* (pp. 89-122). Hillsdale, N.J.: Lawrence Erlbaum Associates.
- Pedemonte, B. (2001). Some cognitive aspects of the relationship between argumentation and proof in mathematics. In M. van den Heuvel-Panhuizen (Ed.), *Proceedings of the 25th Conference of the International Group for the Psychology of Mathematics Education* (Vol. 4, pp. 33-40). Utrecht, The Netherlands.
- Peirce, C. S. (1960). *Collected Papers II, Elements of Logic*. Harvard: University Press.
- Perkins, D. N. (1985). The fingertip effect: How information-processing technology changes thinking. *Educational Researcher*, 14(7), 11-17.
- Perkins, D. N. (1993). Person-plus: a distributed view of thinking and learning. In G. Salomon (Ed.), *Distributed Cognitions: psychological and educational considerations* (pp. 88-110). Cambridge: Cambridge University Press.
- Perks, P., & Prestage, S. (1995). Why don't they prove? *Mathematics in School*, 24(3), 43-45.
- Piaget, J., & Inhelder, B. (1969). *The Psychology of the Child*. NY: Basic Books.
- Pimm, D. (1995). *Symbols and meanings in school mathematics*. New York: Routledge.
- Polya, G. (1954). *Mathematics and plausible reasoning*. Princeton: Princeton NJ University Press.
- Polya, G. (1957). *How to solve it: A new aspect of mathematical method*. New York: Doubleday.
- Prodi, G. (1975/1977). *Matematica come scoperta*. (Vol. 1 & 2). Firenze: D'Anna.
- Rabardel, P. (1995). *Les hommes et les technologies - Approche cognitive des instruments contemporains*. Paris: A. Colin.
- Radford, L. (1999). The Rhetoric of Generalization, *Proceedings of the 23rd Conference of the International Group for the Psychology of Mathematics Education* (Vol. 4, pp. 89-96). Haifa, Israel.
- Rav, Y. (1999). Why do we prove theorems? *Philosophia Mathematica III*, 7, 5-41.
- Rein, M., & Schon, D. (1977). Problem setting in policy research. In C. Weiss (Ed.), *Using social policy research in public policy-making* (pp. 235-251). Lexington, MA: D.C. Heath.
- Robutti, O. (2001). Matematica. In A. Colombo, R. D'Alfonso, & M. Pinotti (Eds.), *Curricoli per la scuola dell'autonomia* (pp. 206-224). Firenze: La Nuova Italia.
- Rouchier, A. (1994). Naissance et Développement de la Didactique des Mathématiques. In M. Artigue, R. Gras, C. Laborde, & P. Tavinot (Eds.), *Vingt ans de Didactique des Mathématiques en France: Hommage à Guy Brousseau et Gérard Vergnaud* (pp. 148-160). Grenoble: La Pensée Sauvage.
- Saada-Robert, M. (1989). La microgénése de la représentation d'un problème. *Psychologie Française*, 34(2/3), 193-206.
- Sackur, C., Drouhard, J.-P., & Maurel, M. (2000). Experiencing the necessity of a mathematical statement. In T. Nakahara & M. Koyama (Eds.), *Proceedings of the 24th Conference of the International Group for the Psychology of Mathematics Education* (Vol. 4, pp. 105-112). Hiroshima, Japan.
- Schoenfeld, A. H. (1994). What do you know about mathematics curricula. *Journal of mathematical behaviour*, 13(1), 55-80.
- Schumann, H. (1997). New standards for the solution of geometric calculation problems by using computers. *Zentralblatt für Didaktik der Mathematik*, 97(5), 155-161.
- Schwartz, J., & Yerushalmy, M. (1992). Getting Students to Function in and with Algebra. In G. Harel & E. Dubinsky (Eds.), *The Concept of Function. Aspects of Epistemology and Pedagogy* (Vol. 25, pp. 261-289).

- Scrivener, S. A. R. (1995). Exploiting mental imaging: reflections of an artist on a mathematical excursion. In R. Sutherland & J. Mason (Eds.), *Exploiting Mental Imagery with Computers in Mathematical Education* (pp. 309-321). Berlin: Springer-Verlag.
- Sekigushi, Y. (2000). A teaching experiment on mathematical proof: roles of metaphor and externalization. In T. Nakahara & M. Koyama (Eds.), *Proceedings of the 24th Conference of the International Group for the Psychology of Mathematics Education* (Vol. 4, pp. 129-136). Hiroshima, Japan.
- Silverman, D. (2000). *Doing Qualitative Research. A Practical Handbook*. London: Sage.
- Simon, M. A. (1996). Beyond inductive and deductive reasoning: the search for a sense of knowing. *Educational Studies in Mathematics*, 30, 197-210.
- Simon, M. A. (2000). Reconsidering mathematical validation in the classroom. In T. Nakahara & M. Koyama (Eds.), *Proceedings of the 24th Conference of the International Group for the Psychology of Mathematics Education* (Vol. 4, pp. 161-168). Hiroshima, Japan.
- Sutherland, R., & Balacheff, N. (1999). Didactical complexity of computational environments for the learning of mathematics. *International Journal of Computers for Mathematical Learning*, 4, 1-26.
- Tahta, D. (1995). It must be so. *Mathematics in School*, 24(3), 2-3.
- Tall, D. (1995). *Cognitive development, representations and proof*. Paper presented at the Conference on Justifying and Proving in School Mathematics, Institute of Education, London.
- Teasley, S. D., & Roschelle, J. (1993). Constructing a Joint Problem Space: the Computer as a Tool for Sharing Knowledge. In S. P. Lajoie & S. J. Derry (Eds.), *Computers as Cognitive Tools* (pp. 229-258). London: Chapman & Hall.
- The Royal Society, & Joint Mathematical Council. (2001). *Teaching and learning geometry 11-19* (Policy document 15/01). London: The Royal Society.
- Thurston, W. P. (1995). On proof and progress in mathematics. *For the Learning of Mathematics*, 15(1), 29-37.
- Toulmin, S. E. (1958). *Fundamental of argumentation theory*. Cambridge: Cambridge University Press.
- Trognon, A. (1993). How does the process of interaction work when two interlocutors try to resolve a logical problem? *Cognition and Instruction*, 11(3&4), 325-345.
- Turkle, S., & Papert, S. (1990). Epistemological pluralism: styles and voices within the computer culture. *Signs*, 16(1), 345-377.
- Verillion, P., & Rabardel, P. (1995). Cognition and artifacts: a contribution to the study of thought in relation to instrumented activity. *European Journal of Psychology of Education*, 10, 77-101.
- von Glasersfeld, E. (Ed.). (1991). *Radical constructivism in mathematics education*. Dordrecht: Kluwer Academic Publishers.
- Vygotsky, L. S. (1978). *Mind in society. The development of higher psychological processes*. Cambridge, MA: Harvard University Press.
- Vygotsky, L. S. (1987). *The collected works of L.S. Vygotsky: Vol.1, Problems of general psychology. Including the volume Thinking and speech* (N. Minick, Trans.). New York: Plenum.
- Watson, J. (1995). Why Proof? *Mathematics in School*, 24(3), 16-17.
- Wegerif, R., & Mercer, N. (1997). Using computer-based text analysis to integrate qualitative and quantitative methods in research on collaborative learning. *Language and Education*, 11(4), 271-286.
- Wells, D. (1995). Defective views. *Mathematics in School*, 24(3), 24-25.

- 
- Wertsch, J. (1998). *Mind as Action*. New York: Oxford University Press.
- Winbourne, P., Barton, B., Clark, M., & Shorter, G. (2001). A community of practice associated with Graphic Calculators. In M. van den Heuvel-Panhuizen (Ed.), *Proceedings of the 25th Conference of the International Group for the Psychology of Mathematics Education* (Vol. 1, pp. 379). Utrecht, The Netherlands.
- Wu, H. (1996). The mathematician and the mathematics education reform. *Notices of the American Mathematical Society*, 43(12), 1531-1537.
- Yerushalmy, M. (1997). Reaching the unreachable: technology and semantics of asymptotes. *International Journal of Computers for Mathematical Learning*, 2, 1-25.

## APPENDIX A. THE PROBLEMS FOR THE INTERVENTION STUDY IN THE ENGLISH SETTING

This appendix contains the problems used in the intervention study in the English setting (see chapter 4, p.72).

This study consisted of both classroom work and work at a distance, through a video conferencing equipment. The structure of the intervention is presented in Table A.1.

Sessions	Learning objectives
7 classroom based sessions of 2 hours each	To access the basic and essential ideas involved in the process of proving statements in mathematics, moving from the elaboration of conjectures to their justification and formalisation.
project work carried out over a period of 6 weeks	To work independently following up what had been previously done; to explore an open situation and produce conjectures and proofs.
5 video tutorials <sup>1</sup> (1 for each student)	To interact with a tutor to get support in their work for the project
Final video presentations (1 for each student)	To communicate findings (conjectures and proofs) through a video conferencing tool

Table A.1. The intervention in the English setting

Table A.2 provides an overview of the classroom based sessions.

Date	Classroom-based sessions	Learning objectives	Cabri objectives
Session 1 22/09/1999	Construction of parallelograms in Cabri according to the definition + discovering properties.	Constructing quadrilaterals with Cabri. Exploring properties of quadrilaterals.	Constructing figures in Cabri. Using the dragging test.
Session 2 27/09/1999	A problem: Angle bisectors of a quadrilateral.	Conjecturing & proving.	Using dragging for discovering.
Session 3 29/09/1999	Other conjectures and proofs for the angle bisectors problem. A locus problem.	Generalising conjectures. Proving. Learning how to solve a locus problem.	The locus feature.
Session 4 04/10/1999	A proof for the locus problem. The treasure hunting problem.	Proving a given locus. Conjecturing & proving.	
Session 5 06/10/1999	Proofs for the treasure hunting problem.	Understanding the proving process.	

<sup>1</sup> This part of the study is reported in (Moenne, Barnes, & Sutherland, 2000).



Session 6 18/10/1999	The game of proving: a problem with quadrilaterals.	Communicating and writing proofs.	
Session 7 20/10/1999	Exploration of a mechanism to draw conics: the Ellissograph of Van Schooten.	Exploring a mathematical mechanism. Recognising conics. Finding properties of conics.	Exploring a virtual mechanism.

Table A.2. The classroom-based sessions in the English setting

### A.1 SESSION 1. CONSTRUCTING AND DISCOVERING PARALLELOGRAMS

The following is a possible definition of a parallelogram.

A parallelogram is a quadrilateral with two pairs of opposite sides parallel.

Using the above definition construct a parallelogram in Cabri. Find out as many 'minimum sets' of properties as you can about a parallelogram and write them down in the Cabri workspace.

Now try to construct a parallelogram for each of your discovered 'minimum sets' of properties. Define a macro in Cabri for each of your constructions. Set your Cabri workspace so that others could understand your construction and assumptions about properties.

When you are sure about at least two 'minimum sets' of properties write down a justification of the equivalence of these two sets of properties. (We shall want you to discuss your justifications with the rest of the group so please write them on an OHP transparency).

### A.2 SESSION 2. ANGLE BISECTORS OF A QUADRILATERAL

Let ABCD be a quadrilateral. Consider the bisectors of its internal angles and the intersection points H, K, L, M of pairs of consecutive bisectors.

1. Drag ABCD, considering different configurations. What happens to the quadrilateral HKLM? What kind of figure does it become?

2. Can HKLM become any quadrilateral? Why?

3. Can HKLM become a point? Which hypothesis about ABCD do you need in order to have this situation?

Write down your conjectures and prove them.

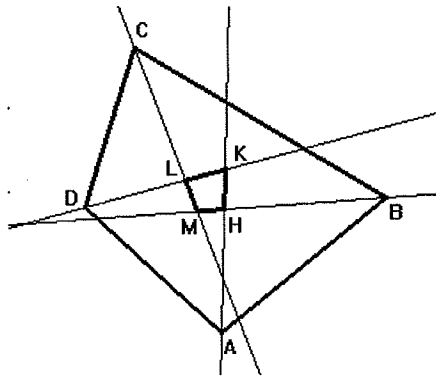

Figure A.1. Angle bisectors of a quadrilateral.

### A.3 SESSION 3. LOCUS PROBLEM

You are given a circle  $c$  and a point  $A$ .  $P$  is a point on the circle  $c$ .

Predict what is the locus of the midpoint of  $AP$ , as  $P$  moves on  $c$ .

Check your prediction in Cabri (you can use the commands 'trace', 'locus' and 'animation').  
Were you right? Describe the locus and explain why you get this shape.

Explore how the locus changes if you move  $A$  and if you change the radius of the circle  $c$ .

Write down conjectures and prove them.

---

#### A.4 SESSION 4 AND 5. THE TREASURE HUNTING

One day, in a serious mathematical book, we came across a problem which appeared to have some connection with either Conan Doyle's or Stevenson books. The problem was about a treasure map. A man left instructions about how to discover the place where a treasure had been hidden in an island, knowing only the position of three trees: a pine, an oak and an apple tree. In order to discover the treasure a man has to position himself where the apple tree is and then:

1. walk till the oak counting the steps, then turn right (90 degrees), walk the same number of steps and put a mark where he arrives.
2. come back to the apple tree, walk to the pine counting the steps, then turn left (90 degrees), walk the same number of steps and put a mark where he arrives.

The treasure will be in the midpoint of the line joining the two marks.

The man who had these instructions goes to the island; when he arrives he finds out that the apple tree is missing. Will he be able to discover the treasure?

Write down your conjectures and justify them.

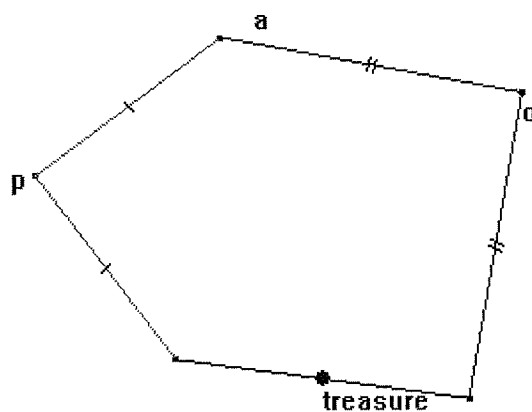

Figure A.2. The treasure hunting

## A.5 SESSION 6. THE GAME OF PROVING

The purpose of this session is the communication of proofs.

We want you to work on the following problem in Cabri.

You are given a quadrilateral ABCD. Construct a square on each of the sides AB, BC, CD and AD, outside the quadrilateral. Construct the centres of the squares (intersection of the diagonals) and name them P, Q, R and S respectively.

Explore the quadrilateral PQRS in relation to ABCD (taking into account sides, angles, diagonals, etc....).

Come up with conjectures and then choose one or two and prove them.

We will ask you to communicate these proofs to other students who will examine them from a rigorous mathematicians' perspective.

This means:

- They will see if they can understand them
- They will check for the givens of the conjectures
- They will check for correct deductions and justifications.

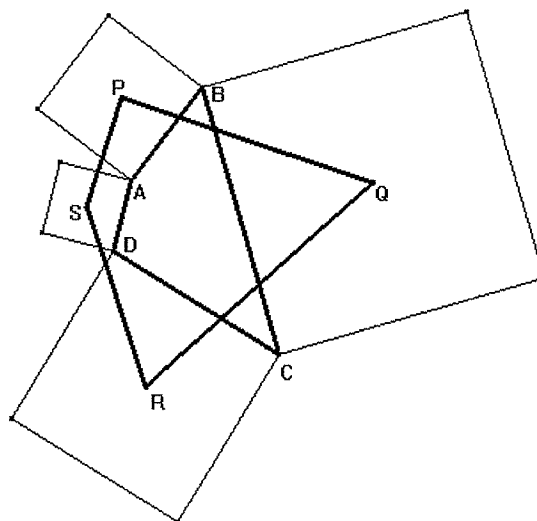

Figure A.3. The game of proving

---

## APPENDIX B. THE PROBLEMS FOR THE INTERVENTION STUDY IN THE ITALIAN SETTING

This appendix contains the problems used in the classroom intervention in the Italian setting (see chapter 4, p.74). Table B.1 illustrates the classroom sessions which formed the intervention study.

Date	Classroom	Problem	Learning objectives
01/02/2000	II C Berti	Perpendicular bisectors of a quadrilateral	Conjecturing and proving
09/02/2000	IV D Issel	Perpendicular bisectors of a quadrilateral	Conjecturing and proving
16/02/2000	II E Galileo Ferraris	Perpendicular bisectors of a quadrilateral	Conjecturing and proving
26/04/2000	II D Berti	Varignon's problem	Conjecturing and proving

Table B.1. The classroom-based sessions in the Italian setting

The problems are written both in Italian and English.

### B.1 VARIGNON'S PROBLEM

Sia dato un quadrilatero ABCD e siano L, M, N e P rispettivamente i punti medi dei lati AB, BC, CD, DA.

1. Quali proprietà ha il quadrilatero LMNP?
2. Quali configurazioni particolari assume il quadrilatero LMNP?
3. Quali ipotesi sul quadrilatero ABCD occorre fare affinché LMNP assuma tali configurazioni particolari?

Draw any quadrilateral ABCD. Draw the midpoints L, M, N, P of the four sides.

1. Which properties does the quadrilateral LMNP have?
2. Which particular configurations does LMNP assume?
3. Which hypotheses on the quadrilateral ABCD are needed in order for LMNP to assume those particular configurations?

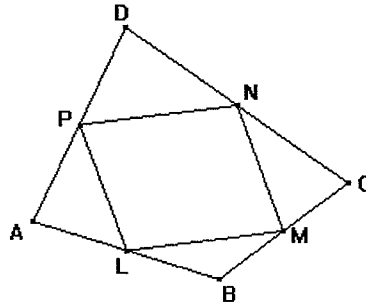

Figure B.1. Varignon's problem

## B.2 PERPENDICULAR BISECTORS OF A QUADRILATERAL

Sia dato un quadrilatero  $ABCD$ . Tracciate gli assi  $a$  del lato  $AB$ ,  $b$  del lato  $BC$ ,  $c$  del lato  $CD$ ,  $d$  del lato  $DA$ . Sia  $H$  il punto di incontro degli assi  $a$  e  $b$ ,  $K$  il punto di incontro di  $a$  e  $d$ ,  $L$  il punto di incontro di  $c$  e  $d$ ,  $M$  il punto di incontro di  $c$  e  $b$ .

Studiate come varia  $HKLM$  al variare di  $ABCD$ .

Dimostrate le congetture prodotte durante l'esplorazione fatta in Cabri.

You are given a quadrilateral  $ABCD$ . Construct the perpendicular bisectors of its sides:  $a$  of  $AB$ ,  $b$  of  $BC$ ,  $c$  of  $CD$ ,  $d$  of  $DA$ .  $H$  is the intersection point of  $a$  and  $b$ ,  $K$  of  $a$  and  $d$ ,  $L$  of  $c$  and  $d$ ,  $M$  of  $c$  and  $b$ .

Investigate how  $HKLM$  changes in relation to  $ABCD$ .

Prove your conjectures.

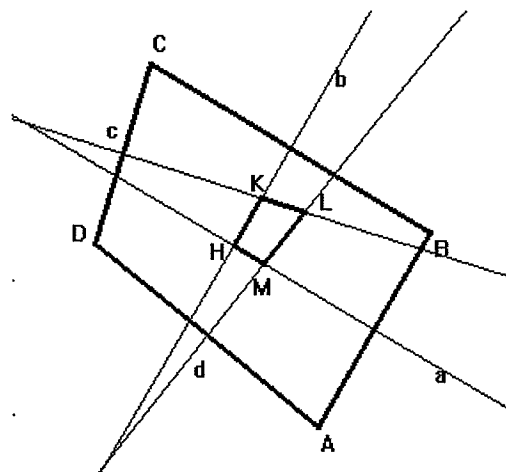

Figure B.2. Perpendicular bisectors of a quadrilateral

## APPENDIX C. THE TRANSCRIPT OF BARTOLOMEO AND TIZIANA (B&T -CASE 1)

### C.1 THE CONTEXT

Bartolomeo and Tiziana are 15-year-old students from a second year classroom of a Liceo Scientifico in Turin (Italy)<sup>1</sup>. They are medium achievers. They had already used Cabri over the year, working on construction and exploration problems. The problem given to the students was: Perpendicular Bisectors of a quadrilateral (Figure C.1). The session took place on the 16<sup>th</sup> February 2000.

You are given a quadrilateral ABCD. Construct the perpendicular bisectors of its sides: a of AB, b of BC, c of CD, d of DA. H is the intersection point of a and b, K of b and c, L of c and d, M of a and d. Investigate how HKLM changes in relation to ABCD. Prove your conjectures.

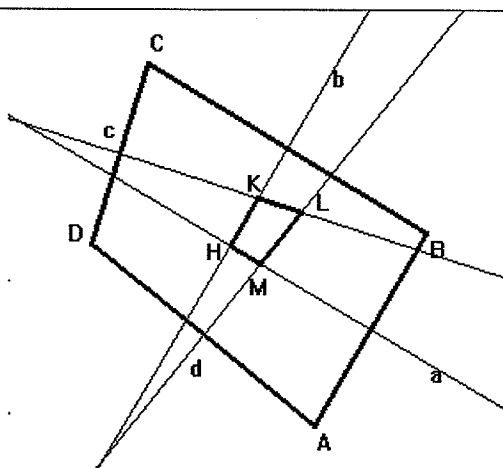
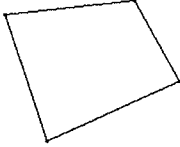
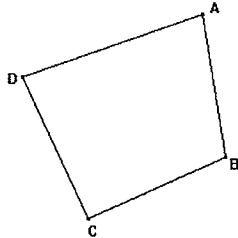

Figure C.1. B&T. Perpendicular bisectors of a quadrilateral

The students were presented with the 'Perpendicular bisectors of a quadrilateral' problem and asked to formulate conjectures and try to prove them. They were given a worksheet with the statement of the problem and were required to write the conjectures down and possibly proofs as well. The session lasted 1 hour and 45 minutes. The teacher was left free to intervene, but she never did. The observer intervened a couple of times: once when the students appeared to be stuck on one particular configuration and she suggested them that they moved on to something else, and a second time to suggest that the students went back to an interesting configuration they had abandoned.

<sup>1</sup> For a detailed description of the context of the Italian setting see chapter 4 (p.74).

## C.2 THE TRANSCRIPT

	Bartolomeo	Teacher/ Observer	Tiziana
		<b>C.2.1 Episode 1. Constructing the figure</b>	
	1. <i>Bartolomeo: go to segment</i>		
		2. Tiziana has got the mouse and Bartolomeo uses the keyboard. At the beginning Bartolomeo tells Tiziana what to do: Tiziana constructs a quadrilateral (Figure C.2)	
			 <p>Figure C.2</p>
0.00.29			3. <i>Tiziana: right</i>
	4. <i>Bartolomeo: ok, maybe you can make it bigger so that we can see it better</i>		
			5. <i>Tiziana: how can I do that?</i>
	6. <i>Bartolomeo: go to that arrow and then drag it</i>		
			7. <i>Tiziana goes to the pointer</i>
			8. <i>Tiziana: and then?</i>
	9. <i>Bartolomeo: go to the point and drag it</i>		
			10. <i>Tiziana drags the 2 points at the top.</i>
			11. <i>Tiziana: ok, and then? Shall I give names to the points?</i>
	12. <i>Bartolomeo: yes</i>		
		13. Tiziana moves the mouse to the menu options 'names' and Bartolomeo writes the letters with the keyboard (FigureC.3)	
			 <p>FigureC.3</p>
0.01.34			14. <i>Tiziana: then...</i>
	15. <i>Bartolomeo: (reading) "construct the perpendicular bisector of AB...", perpendicular bisector... of AB</i>		
			16. Tiziana goes to "perpendicular bisector"
			17. <i>Tiziana: how do you construct a perpendicular bisector ?</i>
	18. <i>Bartolomeo: eh... perpendicular bisector of this segment (pointing at AB) ...</i>		
			19. <i>Tiziana: eh...</i>
	20. <i>Bartolomeo: no, wait, go to pointer... ok, then go to perpendicular</i>		

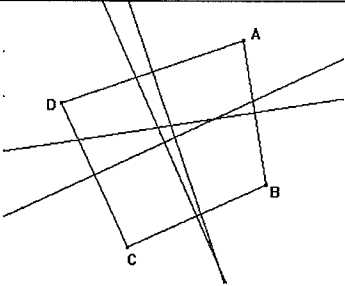
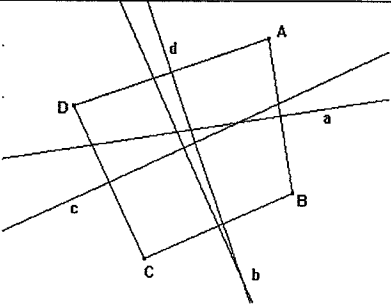

	bisector...		
			21. Tiziana follows the instructions and draws the perpendicular bisector of AB
	22. Bartolomeo: ... and do the same for all of them.		
0.02.07			23. Tiziana draws the perpendicular bisectors of the sides of ABCD (FigureC.4)
			 <p style="text-align: center;">FigureC.4</p>
	24. Bartolomeo: ok. Now we must give names to them...eh... of AB, the one of AB...		
			25. Tiziana: ah no, but we need ...
			26. Tiziana gives the name to the perpendicular bisector of AB
	27. Bartolomeo: ... this line: a. Then that one BC, of the side BC... the name is b... CD, is c... the other one is d.		
		28. While Bartolomeo is talking, Tiziana follows the words and moves the 4 sides of ABCD and Bartolomeo writes the names for the perpendicular bisectors. (FigureC.5)	
			 <p style="text-align: center;">FigureC.5</p>
0.02.50	29. Bartolomeo: well, now we need to do... H is the intersection of a and b. Then ...		
			30. Tiziana: Wait, so... is it this one? (she points at the intersection between a and b)
	31. Bartolomeo: yes!		
			32. Tiziana: do I need to do the intersection?
	33. Bartolomeo: ...intersection of two objects		
			34. Tiziana does the intersection of a and b
	35. Bartolomeo: then...		
			36. Tiziana: wait! Wait!... eh, yes
	37. Bartolomeo: we put then at the end... K of a and d		
			38. Tiziana marks the intersection of a and d

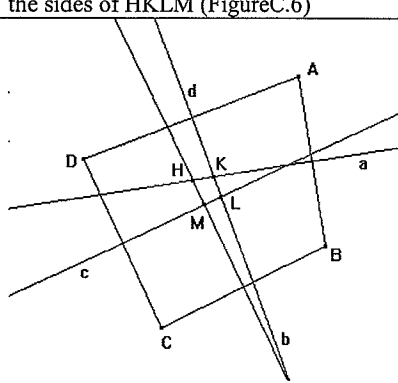
	39. <i>Bartolomeo: ... L of c and d</i>		
			40. <i>Tiziana: c and d</i>
	41. <i>Bartolomeo: M of c and b</i>		
			42. Tiziana marks all the intersection points
	43. <i>Bartolomeo: now you must give the names...</i>		
0.03.41			44. <i>Tiziana: maybe... so...</i>
	45. <i>Bartolomeo: H of a and b... then K, a and d... L of c and d...and the other one is M</i>		
		46. Tiziana puts the names, Bartolomeo writes the letters and Tiziana drags the letters outside the internal quadrilateral	
0.04.24	47. <i>Bartolomeo: ok, now "study how HKLM changes when ABCD changes"... ah well,, do the segments... you must connect the points</i>		
			48. Tiziana constructs the segments on the sides of HKLM (FigureC.6)
			 <p>FigureC.6</p>
		<b>C.2.2 Episode 2. Starting to explore. Formulating a conjecture about the parallelogram (C1)</b>	
0.05.04	49. <i>Bartolomeo: did you do it for L and M? Now go to pointer and let's try to move...</i>		
			50. <i>Tiziana: no, wait, shall we delete...? No</i>
	51. <i>Bartolomeo: try to move...</i>		
			52. Tiziana drags D randomly rightwards and then leftwards
	53. <i>Bartolomeo: so, let's do this...</i>		
			54. <i>Tiziana: eh, excuse me, isn't that a...</i>
	55. <i>Bartolomeo: hide the lines, the points are connected anyway</i>		
			56. Tiziana hides the perpendicular bisectors (FigureC.7)

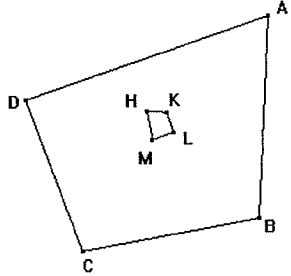
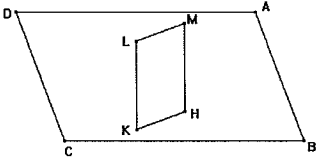
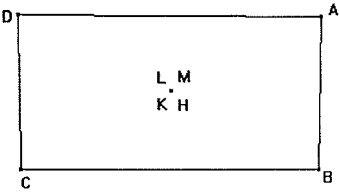
			 <p>FigureC.7</p>
0.05.46	57. <i>Bartolomeo: ok, try to make it a trapezium...</i>		
			58. Tiziana drags D
			59. <i>Tiziana: is it a trapezium?</i>
	60. <i>Bartolomeo: let's see what happens in every case, shall we?</i>		
			61. <i>Tiziana: wait, eh... let's do this...</i>
			62. Tiziana drags C
0.06.18	63. <i>Bartolomeo: ... a parallelogram?</i>		
			64. Tiziana stops moving when she gets a parallelogram (FigureC.8)
			 <p>FigureC.8</p>
	65. <i>Bartolomeo: ok, so... if ABCD is a parallelogram, then...</i>		
			66. <i>Tiziana: this is a parallelogram too</i>
	67. <i>Bartolomeo: ... that is a parallelogram too. Let's write it down... so...then we need to prove it of course</i>		
0.07.03	68. Bartolomeo writes down the first conjecture: "if ABCD is a parallelogram, HKLM is a parallelogram."		
		<b>C.2.3 Episode 3. Exploring the case of the point (C2) and the case of the trapezium (C3).</b>	
			69. Meanwhile Tiziana drags ABCD into a rectangle (FigureC.9)
			 <p>FigureC.9</p>
	70. <i>Bartolomeo: what have you done, a rectangle?</i>		
			71. <i>Tiziana: yes, well...</i>

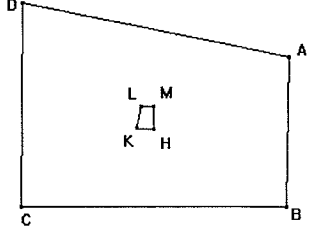
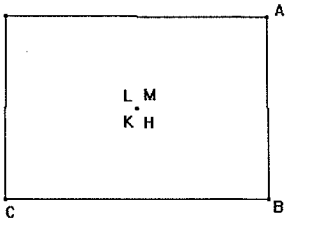
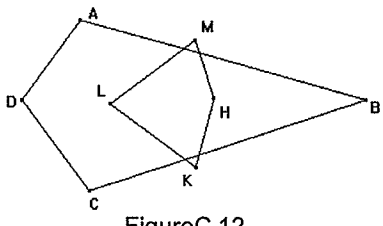
	72. <i>Bartolomeo: so... it is a point... try to make it bigger...</i>		
			73. <i>Tiziana: eh, how can I do that?</i>
0.07.37	74. <i>Bartolomeo: just dragging!</i>		
			75. Tiziana drags D up and stops to observe and think (FigureC.10)
			 <p>FigureC.10</p>
			76. <i>Tiziana: excuse me! This (she points at LM) follows what this (AB) does, this (LK) follows this (AD) ... (she laughs)</i>
	77. <i>Bartolomeo: let's examine some more cases</i>		
			78. Tiziana drags A up and gets FigureC.11
			 <p>FigureC.11</p>
0.08.06	79. <i>Bartolomeo: ah, when it's a rectangle it's always a point... (he writes down the second conjecture) ... if... shall I write "disappears" or "is a point"? It's a point...</i>		
			80. <i>Tiziana: no, because now it's a point too (Tiziana dragged B so that ABCD is not a rectangle, but HKLM is always a point)</i>
	81. <i>Bartolomeo: eh...well..., but if it is a rectangle it is a point ... it's not the only case ...</i>		
0.08.32			82. Tiziana drags B fast, but she slows down when she is nearby the positions which make HKLM a point
	83. <i>Bartolomeo: try... can I? ... let's try something</i>		
0.09.23	84. Bartolomeo takes the mouse and drags the points		
	85. <i>Bartolomeo: so, let's try with a kite</i>		
	86. Bartolomeo stops in FigureC.12		
	 <p>FigureC.12</p>		
			87. <i>Tiziana: excuse me?, eh...</i>
	88. Bartolomeo drags B to get a square (FigureC.13)		

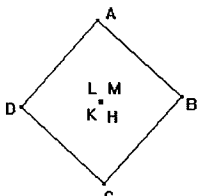
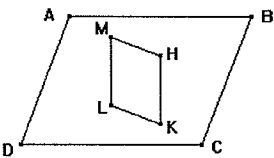
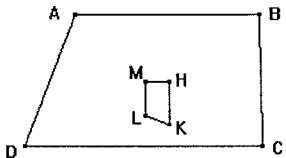
	 <p>FigureC.13</p>		
0.09.54	89. Bartolomeo: ... square... yes, because if ...it happens... well, if also the rectangle...		
			90. Tiziana: that is, but ... if it is a rectangle it is a point ...
			91. Tiziana draws a rectangle on paper with the perpendicular bisectors intersecting in a point.
			92. Tiziana: ... of course it's point!
	93. Bartolomeo: sure! But this is the proof ...wait...		
	94. Bartolomeo drags and makes ABCD a parallelogram (FigureC.14)		
	 <p>FigureC.14</p>		
0.10.49	95. Bartolomeo: so we said that this is a parallelogram and inside it's a parallelogram too ...		
			96. Tiziana writes down on paper the following correspondences between the sides of the quadrilaterals: AB→ML, DC→HK
0.11.10	97. Bartolomeo: try to make it a trapezium		
			98. Tiziana: yes
			99. Tiziana takes the mouse and drags C on the right (FigureC.15)
			 <p>FigureC.15</p>
	100. Bartolomeo: ... it becomes a trapezium too		
			101. Tiziana: so LK follows AD... (she writes it down)
	102. Bartolomeo: so this one (she points at MH) would be the other side... that is not parallel...so it should follow BC		
			103. Tiziana: HM?
	104. Bartolomeo: yes		
			105. Tiziana: HM is this one (he points at MK with a pen on the screen)
0.11.57	106. Bartolomeo: MH... MH		
			107. Tiziana: ah... so what? This one (Tiziana points at BC with the mouse) must follow...
	108. Bartolomeo: it's opposite to LK... this one is the non parallel side ... so it must be BC... then, ML.... Try to make		

	<i>it a parallelogram</i>		
			109. Tiziana writes on paper the last correspondence: $BC \rightarrow MH$ . Then Tiziana drags B and stops FigureC.16
			<p>FigureC.16</p>
0.13.00	110. <i>Bartolomeo: so we said that AD follows LK... BC, MH... right</i>		
			111. <i>Tiziana: but look, I wrote them down</i>
		<b>C.2.4 Episode 4. Proving the case of the parallelogram (C1-P1).</b>	
		<b>a. wanting to prove conjecture C1</b>	
	112. <i>Bartolomeo: yeah, I just wanted to check it.... So we need to prove that MHLK is a parallelogram... so...</i>		
			113. Tiziana goes to "hide/show" and all the lines are visible
0.13.56			114. <i>Tiziana: but it isn't a parallelogram!</i>
	115. <i>Bartolomeo: you're right, wait... let's do something... do... go there... there should be "parallel line"... draw a line through... parallel to this line, parallel to this segment (AD) ... through B</i>		
			116. While Bartolomeo is talking Tiziana follows the instructions and draws the line through B parallel to AD (FigureC.17)
			<p>FigureC.17</p>
0.14.30	117. <i>Bartolomeo: so you see, this is not a parallelogram either ... if we make this a parallelogram (he means ABCD and he drags C so that BC coincide with the line through B - FigureC.18) ... then that one is a parallelogram too (HKLM)</i>		

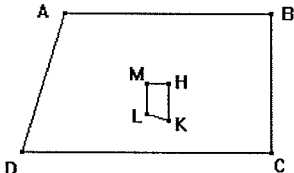
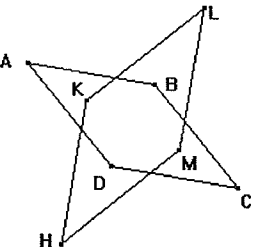
	FigureC.18		
			118. Tiziana: yes
	119. Bartolomeo: now we must prove that it is a parallelogram. So ... well...		
0.15.50		120. Silence for 30 seconds	
	121. Bartolomeo: wait...		
	122. Bartolomeo shows the perpendicular bisectors again, hides the line through B and moves the names		
		<b>b. summarising conjectures and detour on another conjecture</b>	
	123. Bartolomeo: so, study how HKLM changes when ABCD changes. We said that if it is a parallelogram, then the internal one is a parallelogram too. If it is a rectangle... also a square (he adds the word square to the second written conjecture). The we saw that if this is a trapezium ... (Bartolomeo moves B so that ABCD becomes a trapezium – FigureC.19) ... also that one (he points HKLM with the mouse) is a trapezium.... Then, if this is a rhombus (? drags B and D to make ABCD a rhombus – FigureC.20) ... that one is a rhombus too (HKLM) ... it's not a nice rhombus...really...		
	 <p>FigureC.19</p>		
	 <p>FigureC.20</p>		
0.18.14	124. Bartolomeo tries to move K, but he can't, and then he writes down the last two conjectures: "3 <sup>a</sup> ) if ABCD is a rhombus, then HKLM is a rhombus. 4 <sup>a</sup> ) if ABCD is a trapezium, then HKLM is a trapezium"		
		<b>c. Bartolomeo tries proving conjecture C1 (P1)</b>	
	125. Bartolomeo: ok, now we need to prove... let's do the parallelogram, I think it's easier		
			126. Tiziana drags the points to get a parallelogram. She can't do it perfectly so Bartolomeo helps her and they get FigureC.21.

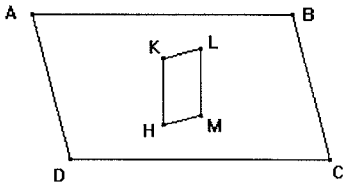
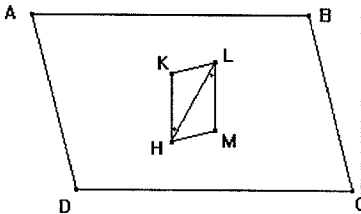
			 <p>FigureC.21</p>
0.20.08	127. Bartolomeo: so... we must prove those two are parallel... we can ...		
			128. Tiziana: is that it?
	129. Bartolomeo: delete this (the line through B) 'cause we don't need it		
			130. Tiziana does this and then makes the perpendicular bisectors visible
	131. Bartolomeo: so... we can prove that this equals this (he means KL and MH, and he takes measurements for those sides, checking they are equal [1,61])... ok, we've just seen that really this equals that (he points with the mouse the two equal measurements). So ...		
0.21.18			132. Tiziana: but, you haven't proven they are parallel!
	133. Bartolomeo: no, but I prove they are equal. It's enough to say that they are ...		
			134. Tiziana: ... opposite angles (She points at the angles on the screen with her fingers)
0.22.31	135. Bartolomeo: ...internal alternate?... ah, opposite...		
	136. Bartolomeo: we can trace the diagonal and consider that as the transversal of lines d and b, and then check if the alternate internal angles are equal ... because if they are equal the lines are parallel....		
	137. Bartolomeo draws HL(FigureC.22) and marks the angles MLH e LHK		
	 <p>FigureC.22</p>		
	138. Bartolomeo: it marks them equal, so it means that since they are ... alternate internal equal ... KL and HM are... parallel... however we should prove that they are alternate internal equal, because it's not enough ...		
			139. Tiziana: why, can it mark them different too?
0.23.06	140. Bartolomeo: I think so		
			141. Tiziana: let me see
	142. Bartolomeo: let's try		
	143. Bartolomeo wants to mark the angle A, but then he changes his mind		
			144. Tiziana: eh, it marks them equal
0.24.00	145. Bartolomeo: therefore let's do this		

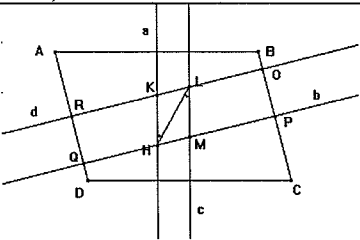

	(he's about to select the menu "measure angle")...but we are in the same position again, that is enough to put measurements, and then ... we should prove ...so...		
	146. Bartolomeo measures the angles KHL e LHM, and then deletes the 2 numbers		
	147. Bartolomeo: look, they are equal!		
		148. About 30 seconds of silence	
0.24.45	149. Bartolomeo: what shall we do?... so, we know it's true, but we need to prove it y... well, we can prove that HLM, this triangle, equals that one (he points at the triangle KLH with the mouse), so if they will be equal, the angles in L and in H will be equal too; so these are parallel (points at KL e HM), is that right?		
0.25.33			150. Tiziana: right, but anyway...
	151. Bartolomeo: they share this (points at HL), then... now...		
		152. About 45 seconds of silence	
	153. Bartolomeo: so let's consider these 2 lines (b and d)... and let's consider KH as the transversal... so they are parallel, therefore this angle (in K) should equal ... that one! Right?		
			154. Tiziana: yes
	155. Bartolomeo: so this being a flat angle (he points at the angle between line b in H with the mouse), also this one (the one delimited by d in K)...		
0.26.40			156. Tiziana: yes, so this one (points at HKL) and this one (points at KHM) are supplementary
	157. Bartolomeo: right, they are supplementary. So if they are supplementary we can nearly say it is a parallelogram ... it's true...		
			158. Tiziana: nearly!
0.28.48	159. Bartolomeo: nearly. Then we do the same on the other side (points at L)... so... (writes down on his notebook) the angle in K equals angle KHM. Then the angle in H equals angle... LKH. Therefore $LKH + KHM = 180^\circ$ , right? Ok. Then we do the same thing here... wait, let's do something		
	160. Bartolomeo tries to delete the angle marks but he is not very successful		
	161. Bartolomeo: no, it was annoying me.... So, we know that this plus this equals this (he refers to the angles he mentioned before while writing on paper), ok? Also this plus this (points at angles KLM and HML with the mouse), right?		
0.29.47			162. Tiziana: if that (HKLM) is a parallelogram!
	163. Bartolomeo: no, we proved it!... we just need to know that they are parallel		
		<b>d. Tiziana proves conjecture C1 (P1)</b>	
			164. Tiziana: and you don't know that

	165. <i>Bartolomeo: well, this one outside (points at ABCD) is a parallelogram</i>		
0.30.15			166. <i>Tiziana: because you constructed it</i>
	167. <i>Bartolomeo: yes, because I constructed it ... and these are parallel (points at the perpendicular bisectors b and d with the mouse) because.... So this plus this equals 180° (he repeats the reasoning around angles K and H) and also this plus this (angles L and M), therefore if... ah, yes, wait ...</i>		
			168. <i>Tiziana: so, wait, this one is the midpoint (points at the midpoint of BC with her finger), this is another midpoint (points at the midpoint of AD)...</i>
0.30.54	169. <i>Bartolomeo: perfect!</i>		
			170. <i>Tiziana: so... nothing... no, wait...</i>
	171. <i>Bartolomeo: we just need to know...</i>		
			172. <i>Tiziana: if these are parallel (points at AD and BC with her fingers), this one is the trasversale (b)...</i>
0.31.14	173. <i>Bartolomeo: no, wait these are parallel, this is the trasversale (he repeats Tiziana's discourse using the mouse to point at the figure), this... angle (BPQ, as in FigureC.23, which has been added to facilitate the understanding) equals this one (DQP), this one equals this one (BOR and DRO)...</i>		
	 FigureC.23		
			174. <i>Tiziana: this equals this one (DRO and DQP) and they are parallel!</i>
	175. <i>Bartolomeo: so, wait, if this is a right angle I can say that...</i>		
			176. <i>Tiziana: no, but it's not a right angle, what are you talking about? So ...</i>
	177. <i>Bartolomeo: ... it must be, otherwise they are not parallel</i>		
0.31.44			178. <i>Tiziana: so BC is parallel to AD by construction; then...that thing ...this ...it's the midpoint and this is another midpoint (points at P and R, respectively midpoints of BC and AD)</i>
	179. <i>Bartolomeo: wait, let's mark them</i>		
	180. <i>Bartolomeo marks the midpoints of BC and AD</i>		
			181. <i>Tiziana: now, since these are parallel, this angle here (points at CPQ) equals that angle there (AQP). Then, this angle here (COR) equals that angle there (ORA), so they are... correspondent (points at angles PQA and ORA); therefore this and this are parallel (points at d and b)....I made it!</i>
0.32.22	182. <i>Bartolomeo: so, wait, let's summarise it... so this...</i>		

			183. Tiziana: no, we proved it!
		<b>e. Tiziana explains her proof P1 to Bartolomeo</b>	
	184. Bartolomeo: yes, but I want to understand how you did it ... so do repeat everything slowly ...		
			185. Tiziana: so BC is parallel to AD...
	186. Bartolomeo: right, this is fine		
			187. Tiziana: then this is the midpoint (points at P)... this is the trasversale (b), this is the other trasversale (d)...
	188. Bartolomeo: yes		
			189. Tiziana: now, is this angle here (COR)...
0.33.14	190. Bartolomeo: in B?		
0.33.50			191. Tiziana: no, this one equals ... that one (ARO), because they are alternate internal. Then, this angle here (CPQ) equals that angle there (AQP), because they are alternate internal. Then, this angle here (ORA) and this angle here (PQA) are correspondent...
	192. Bartolomeo: ... so... let's do this... but look, here there are four right angles, otherwise they are not parallel		
0.34.10			193. Tiziana: oddio, ma guarda te!... the perpendicular bisector, isn't it? (points at b) There is always a right angle!
	194. Bartolomeo: I see! How stupid we are! So, therefore, this is right angle, and this one too...and these are right angles. Therefore if it is right angle, they are parallel		
0.34.22			195. Tiziana: so this equals this...
	196. Bartolomeo: they are parallel, ok, fine till now		
			197. Tiziana: and these are parallel too (points at a and c), therefore this is a parallelogram (points at HKLM)
		<b>C.2.5 Episode 5. The case of the rhombus (C4).</b>	
0.34.50	198. Bartolomeo: so we need to look at the rhombus		
	199. Bartolomeo hides the perpendicular bisectors and then drags A, D and B		
			200. Tiziana: the rhombus?
	201. Bartolomeo: sure		
			202. Tiziana: uh, wait a moment... give me (the mouse)!
			203. Tiziana takes the mouse and drag again B
	204. Bartolomeo: so, let's do this, let's draw the bisector (he takes the mouse) through B		
			205. Tiziana: no, wait, ABC...
	206. Bartolomeo draws the bisector of the angle in B (FigureC.24)		

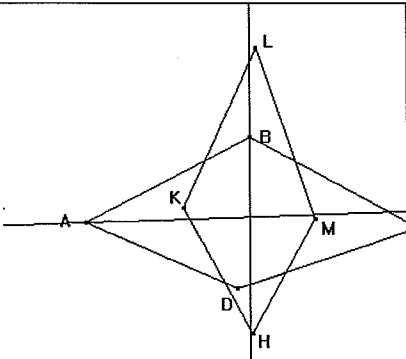
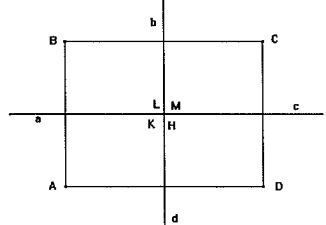
	 <p>FigureC.24</p>		
0.35.58	207. <i>Bartolomeo</i> : ok, now...		
			208. <i>Tiziana</i> : now on this side as well (points at A and C)
	209. <i>Bartolomeo</i> : so... B... A... D... (and draws the bisectors of the angle A)		
			210. <i>Tiziana</i> : wait... (takes the mouse back)
	211. <i>Bartolomeo</i> : the points must coincide		
			212. <i>Tiziana</i> drags C on the bisector of angle A and D on the bisector of angle B
		213. 15 minutes break	
		<b>C.2.6 Episode 6. Proving the case of the point inside (C2 &amp; P2)</b>	
	214. <i>Bartolomeo</i> : in the case when this quadrilateral ( <i>Bartolomeo</i> has got the mouse and points at ABCD – FigureC.25) becomes a rectangle or a square we have that...		
	 <p>FigureC.25</p>		
			215. <i>Tiziana</i> : KLMH changes (si trasforma)... I mean it's a point
0.36.44	216. <i>Bartolomeo</i> : this is because... so this (points at the midpoint of CD) is a midpoint for the perpendicular bisector, isn't it? And this one as well (midpoint of AB). Yes, I mean... so... we can say that, hem... we can consider this as a pencil of parallel lines (points with the mouse, going along, BC, the perpendicular bisectors of AB and CD, and AD)... so we are in the case of <i>Thales theorem</i>		
			217. <i>Tiziana</i> : yes!
	218. <i>Bartolomeo</i> : so since this is the midpoint (points at the midpoint of AB) this bit equals that bit (points at the parts in which AB is divided by its perpendicular bisector) and so also this one equals that on (repeats the same		

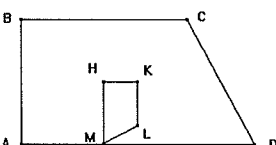
	thing about the two halves of CD)		
			219. Tiziana: <i>of course, it's the midpoint!</i>
	220. Bartolomeo: <i>eh, ok, perfect! Then...</i>		
			221. Tiziana: <i>say this equals that...</i> (repeats this sentence pointing with her fingers at the two equal halves belonging to the opposite sides AB and CD, AD and BC)
0.37.26	222. Bartolomeo: <i>yes...and so they meet at one point only (points at HKLM), because anyway the perpendicular bisectors... since this goes through the midpoint (points with the mouse the midpoints of AB and CD)... the two midpoints are connected by a line parallel to the sides...(points at BC and AD)</i>		
			223. Tiziana: <i>yes</i>
	224. Bartolomeo: <i>... therefore the two perpendicular bisectors coincide ...</i>		
0.38.19			225. Tiziana: <i>yes, but...</i>
	226. Bartolomeo: <i>ok, is they coincide...the points... so they meet at one point only, which is this one ... (points at the points H, K, L, M that coincide).... So we proved it... it must be!</i>		
0.38.56		227. 30 seconds of silence	
		<b>C.2.7 Episode 7. Exploring and proving the case of the right-angled trapezium (C5-P5) and the case of similar quadrilaterals (C8)</b>	
	228. Bartolomeo: <i>so... let's write... the perpendicular bisectors meet at one point, so there can't be a figure... a parallelogram...a quadrilateral (writes down what he's just said)...then...</i>		
		<b>a. discovering and proving C5</b>	
			229. Tiziana: <i>let's do a trapezium</i>
0.39.58	230. Bartolomeo: <i>there is the rhombus first... well, let's do the trapezium (Bartolomeo drags points B and D, then A)</i>		
			231. Tiziana: <i>what's that? Make it right angled!</i>
	232. Bartolomeo: <i>ah, say it!</i> (Bartolomeo drags the points slowly until he gets a right angle trapezium and he stops – FigureC.26. Then he hides the perpendicular bisectors)		
			

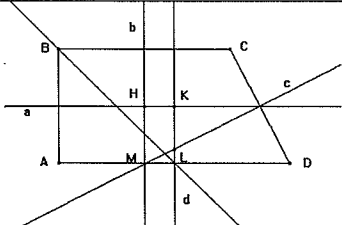
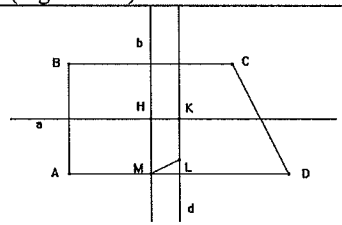
	FigureC.26		
0.40.27	233. <i>Bartolomeo: here you are... so another trapezium is formed. Let's prove it. So let's put the perpendicular bisectors again</i> (Bartolomeo show the hidden lines and perpendicular bisectors – FigureC.27)		
	 <p>FigureC.27</p>		
			234. <i>Tiziana: that on too</i> (points at the line through ML ???)
	235. <i>Bartolomeo: wait, so this is not... we've got too many lines</i>		
			236. <i>Tiziana: no!...</i>
	237. <i>Bartolomeo: so, these ones ok</i> (points at b and d)		
			238. <i>Tiziana: where does this line come from?</i> (points with her finger at the line going through B which was constructed as bisector of B)
0.41.10	239. <i>Bartolomeo: no idea! So</i> (hides that bisector)... <i>is that it?... excuse me... doesn't this go through the midpoint of...</i> (points with the mouse at the line going through LM)... <i>no, ok, so I need to delete this one as well ...</i> (Bartolomeo deletes this line)... <i>because these 2 coincide ...</i> (points at the line through HK, which is the perpendicular bisector of AB, thinking that it coincide with the perpendicular bisector of CD, which is the line just deleted)... <i>as before... parallel</i> (points at BC and AD)... <i>trasversale</i> (points at CD)... <i>ok.... Wait maybe we can do this "colour"</i>		
	240. Bartolomeo puts colours on the sides of HKLM and on the letters (FigureC.28)		
	 <p>FigureC.28</p>		
	241. <i>Bartolomeo: so... therefore... they seem to be similar, we could prove that.... First of all let's prove it is a trapezium. So...</i>		
			242. <i>Tiziana: two parallel sides</i>
0.42.06	243. <i>Bartolomeo: these two lines are parallel</i> (points with the mouse at HM and KL)... <i>then we must prove it is isosceles ...</i>		
			244. <i>Tiziana: sorry, these are...</i> (points at b and d)
	245. <i>Bartolomeo: yes!... and then we need to prove that it is isosceles</i>		
			246. <i>Tiziana: right angle!</i>

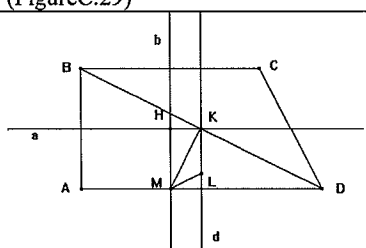
0.42.53	247. Bartolomeo: <i>eh yes, right angle! ... well, that's easy. These are perpendicular (points with the mouse at the line through HK and at b), these being parallel (points at BC and at a, which is the line through HK)... this is a perpendicular (points at b) and so here (in H) a right angle is formed ... proven, insomma. Ok, so we proved it's a trapezium ... that it's isosceles, ehm, yes, right angled... now... they seem similar .... We must prove that BA... is</i>		
		<b>b. Trying to prove C8</b>	
			248. Tiziana: <i>wait... no, nothing</i>
	249. Bartolomeo writes down on paper		
	250. Bartolomeo: <i>...it should... BA sta a HK (points with his fingers at HK on the screen) come AD sta a HM...</i>		
			251. Tiziana: <i>then BC...</i>
	252. Bartolomeo: <i>BC sta a KL, come... CD sta a LH...</i>		
			253. Tiziana: <i>and then the angles must be equal in order to be similar</i>
0.43.37	254. Bartolomeo: <i>yes. Now let's do it by proving ... we must find... but that one is for triangles, excuse me</i>		
			255. Tiziana: <i>no!</i>
	256. Bartolomeo: <i>no? yes</i>		
0.44.04			257. Tiziana: <i>no!</i>
	258. Bartolomeo: <i>ah, well, no, it's enough... excuse me, it's enough to prove that ... let's put a diagonal (points with the mouse at a line from B to D), we prove that ... that a triangle is similar to the other one, so the whole figure is similar, ...it must be</i>		
	259. Bartolomeo draws the diagonal BD of the trapezium ABCD and the diagonal KM of the trapezium HKLM (FigureC.29)		
	 <p style="text-align: center;">FigureC.29</p>		
0.44.59	260. Bartolomeo: <i>so this one (points at ABD) is a right angle triangle, and this one too (points at KHM)... let's mark the opposite angles... (Bartolomeo marks the angles KHM and BAD). Why isn't this right angle?... ah, yes!.... Perfect, then we need to have that this angle (KMH) equals this one (BDA)</i>		
	261. Bartolomeo: <i>(after a few seconds)... or this one too (angle MKH), it's the same! So this triangle (with vertices in H, K and the point of intersection of BD and b) equals this one (with vertices in M, L and the intersection between AD and d)</i>		
			262. Tiziana: <i>pardon?</i>
	263. Bartolomeo: <i>this equals this (he goes along the sides of the two triangles with the mouse)</i>		

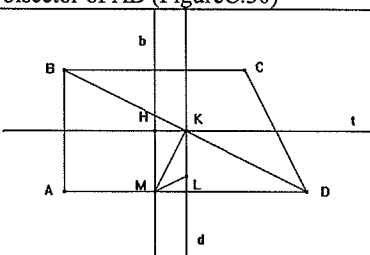
			264. Tiziana: wait, why is that?
0.46.06	265. Bartolomeo: well, because ...if you... have a look at this one: it's a trapezium isn't it? (uses the mouse to go along KL, LM, the segment from M to the intersection point between BD and d, and the segment from this point to K)... and this is a rectangle (uses the mouse to go along MH, HK, the segment from K to the point of intersection between AD and d, and the segment from this point to M)... right? So this is a right angle (points at the angle between AD and d)... this being a trapezium ...then, wait ... yes, it's enough to say that this figure coincide with this one ...		
			266. Tiziana: uh, wait... so...
	267. Bartolomeo: here you are!		
			268. Tiziana takes the mouse
			269. Tiziana: this angle here and that angle there (points with the mouse at MKH and HKB) is $90^\circ$ ... then this is $90^\circ$ (the angle in B)... so this is a parallel (points at BC), this is a parallel line (a, going through H and K), therefore this (angle HKB) equals this one (angle KBC)
	270. Bartolomeo: yes		
			271. Tiziana: well, consequently this one (angle MKH) equals this one (angle AKB)
0.47.34	272. Bartolomeo: yes, ok, fine		
			273. Tiziana: do we need to write down these things?
	274. Bartolomeo: I think so. So... (writing down on paper) $BAD = KHM = 90^\circ$ ... then... $ABD$ equals... (looking for it on the screen with a finger) $HKM$ , because...		
			275. Tiziana: because $BKM$ equals $90^\circ$
	276. Bartolomeo writes it down		
	277. Bartolomeo: the angle in B equals $90^\circ$ ... then considering BC... so I consider BC parallel to ...		
	278. Bartolomeo takes the mouse and give the letter t to the perpendicular bisector of AB (FigureC.30)		
	 <p style="text-align: center;">FigureC.30</p>		
	279. Bartolomeo: ... parallel to t. So the angle CBD (points at the screen with a pen)		
0.49.01			280. Tiziana: ...C...B...D, yes
	281. Bartolomeo: it equals the angle BKH... because alternate internal. So... (writes down what he has just said). Then ... we put together the two things ...		
			282. Tiziana: HKM...
	283. Bartolomeo: HKM		
			284. Tiziana: equals ABD



	285. Bartolomeo writes it down and Tiziana takes the mouse and wants to mark the angle ABD		
0.50.18			286. Tiziana: no!...
	287. Bartolomeo: yes, it's right		
			288. Tiziana: no, it should have marked it
	289. Bartolomeo: no, you used angle measure		
			290. Tiziana: that's true
	291. Bartolomeo: you should do ... mark angle, right		
			292. Tiziana marks the angles ABD and MKH
	293. Bartolomeo: wait, there was an option to put ...here it is ..		
			294. Tiziana: which one?
	295. Bartolomeo takes the mouse and go to "aspetto"		
	296. Bartolomeo: ... "aspetto", in order to mark equal angles		
	297. Bartolomeo marks the angles MKH and ABD with the same angle mark		
	298. Bartolomeo: let's consider these figures...		
0.51.10			299. Tiziana: right, the other one is equal, of course
	300. Bartolomeo: eh beh, yes...so they are similar		
			301. Tiziana: no, the other one must be equal to this one, this one (points at angle BDA with fingers)... equals ...
0.52.10	302. Bartolomeo: of course, because if $180^\circ$ is the sum		
			303. Tiziana: now the other one
	304. Bartolomeo marks the angles KMH and BDA		
			305. Tiziana: now... well, we've got... what are you doing?
	306. Bartolomeo: I wanted to make it bigger (he means the angle mark he has just done)... why can't it make it bigger? ... well, never mind		
		307. 30 seconds of silence	
	308. Bartolomeo: so, having 3 equal angles, they are similar		
			309. Tiziana: so, then... then this is a right angle
	310. Bartolomeo: which one? This one...		
			311. Tiziana takes the mouse
0.53.17			312. Tiziana: this is a right angle (points at angle HKB with the mouse)... this is another right angle (points at HKL): so this one (angle MKL) and this one (angle HKB) are equal because they are made of...
	313. Bartolomeo: so, wait, let's do this...		
			314. Tiziana: ... one angle
0.54.14	315. Bartolomeo: (takes the mouse and points at things while talking) this is a right angle, this is an angle ...since they are made of... yes... so MKL equals... starting from...		
0.55.16			316. Tiziana: MKL equals CBD...
	317. Bartolomeo writes down on paper what Tiziana has just said		

	318. <i>Bartolomeo: then... yes, well, let's write because angle B and angle K equal <math>90^\circ</math> and are made of equal angles, so also the other one ...</i>		
	319. Bartolomeo takes the mouse back and marks angle CBD and angle MKL in the same way (FigureC.31)		
	<p>FigureC.31</p>		
		320. Silence for a minute	
0.56.42	321. <i>Bartolomeo: well, anyway we have that these 2 triangles (points at BKH and MKL) are equal, aren't they? We just need ... So this is a right angle (points at angle HMD)</i>		
			322. <i>Tiziana: ... which equals this one</i>
	323. <i>Bartolomeo: yes...</i>		
	324. Silence for a minute in which Bartolomeo looks for relationships between the angles he marked, pointing at them with the mouse		
0.57.50	325. <i>Bartolomeo: so... this one (points at BC with the mouse)... no, nothing... I was thinking that ... this one here (points at angle HKL with the mouse) is a right angle, and also this one (points at angle HMD).... This little angle here (points at BKH) equals this little angle here (points at LMD), because the 2 triangles are equal ... so this one (angle HKM) equals this one plus this one (points at angle HML), but this doesn't mean anything</i>		
0.58.35	326. <i>Bartolomeo: but wait...</i>		
			327. <i>Tiziana: but does this one (points at angle ADB with a finger) equal this one (points at angle CBD)?</i>
0.59.49	328. <i>Bartolomeo: no!... wait... does this one equal this one (points with the mouse)? Yes, yes, because... yes, because these are parallel (points quickly at segments BC and AD) and this is a cutting line (points at BD with the mouse).</i>		
	329. Bartolomeo mark angles ABD and HMK with the same mark of DBC		
	330. <i>Bartolomeo: no, wait... yes. So...</i>		
		331. Silence for a minute and a half	
	332. <i>Bartolomeo: so, let's do this... if this one is a right angle (points with the mouse at LKH) and this one too is a right angle (points at MKB) and they are made of a same part (points at angles MKH), then this one equals this one (angles LKM and HKB), right?</i>		
			333. <i>Tiziana; no, I didn't understand</i>
	334. <i>Bartolomeo: look, consider this right angle, this one (points at BKM with the mouse and then with a finger) and consider this one (points at HKL)...</i>		
1.00.25			335. <i>Tiziana: that one is the right</i>

			<i>angle, isn't it?</i>
	336. Bartolomeo: <i>yes, but there is another one, this one</i> (points at BKM)		
			337. Tiziana: <i>ah, yes!</i>
	338. Bartolomeo: <i>given that they are made of a same part, a common part</i> (points at angle MKH), <i>this one will equal this one, this angle here equals that angle there</i> (points at angles LKM and HKB), <i>right?</i>		
1.01.43			339. Tiziana: <i>yes</i>
	340. Bartolomeo: <i>then let's mark it</i>		
	341. Bartolomeo marks angle BKH		
1.02.28	342. Bartolomeo: <i>then... ok. So we proved that these triangles</i> (the first with vertices in H, K and the point of intersection between BD and t; the second with vertices M, L and the point of intersection of AD and d) <i>are equal. So this one</i> (Bartolomeo marks angle LMD)... <i>no, wait a moment...</i>		
		343. Silence for 30 seconds	
1.03.22	344. Bartolomeo: <i>so we know that ...this is a right angle</i> (points at MHK) <i>and also this one</i> (points at the angle between d and AD) <i>so then we know that HK equals M... this one, let's put a letter...</i> (Bartolomeo put a letter for the midpoint of AD – FigureC.32)		
	<p style="text-align: center;">FigureC.32</p>		
1.05.18			345. Tiziana: <i>...Z</i>
	346. Bartolomeo: <i>... equals MZ, ok? Then this angle</i> (BKH) <i>equals this one</i> (LMZ), <i>because... no, I was joking</i>		
	347. Bartolomeo change the angle mark for LMZ		
	348. Bartolomeo: <i>this one</i> (points at angle KMZ) <i>equals this one</i> (angle MKH), <i>right? Then we know that this one plus this one</i> (sum of MKH and MKL) <i>is 90°...</i>		
		349. Silence for 2 minutes	
		<b>C.2.8 Episode 8. The case of the isosceles trapezium (C6) and the case of the rhombus (C4)</b>	
		350. O: <i>if you can't go on, try to look for something else. You leave this for a while, then you can go back to it</i>	
1.06.05	351. Bartolomeo: <i>so let's do this...</i>		
	352. Bartolomeo reduce this file as an icon and opens a new file. Then he draws a quadrilateral.		

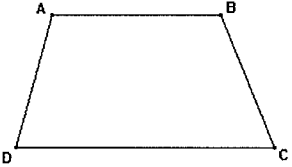
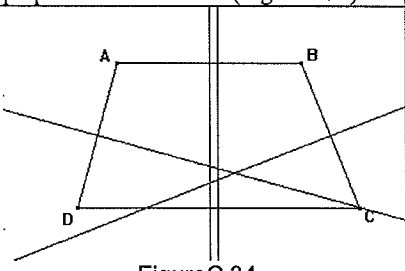
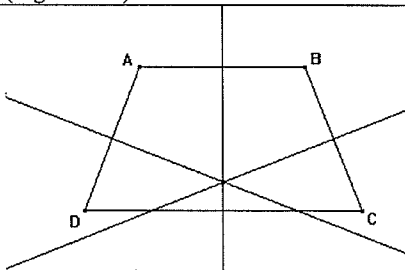
		a. the case of the isosceles trapezium (C6)	
			353. Tiziana: make an isosceles trapezium!
	354. Bartolomeo drags the vertices so that the quadrilateral becomes an isosceles trapezium (FigureC.33). They do not put letters. (for a better comprehension of the transcript we use letters)		
	 <p>FigureC.33</p>		
1.07.15	355. Bartolomeo: I can't tell if it is isosceles... anyway let's do the perpendicular bisectors		
	356. Bartolomeo draws the perpendicular bisectors (FigureC.34)		
	 <p>FigureC.34</p>		
			357. Tiziana: so...
	358. Bartolomeo: we must mark the points again ... better to do it like that, look: first, let's do (drags one vertex of ABCD)... so we mark the points well		
1.08.02	359. Bartolomeo marks the intersection points between the perpendicular bisectors and then drags A making the intersections coincide in one point (FigureC.35)		
	 <p>FigureC.35</p>		
	360. Bartolomeo: ... and a point is formed!... so, look, it's the same proof as before...		
			361. Tiziana: of course, but this is a trapezium!
	362. Bartolomeo: look, if it is isosceles the points coincide anyway		
1.08.52			363. Tiziana: because this is a trapezium!
		<b>b. Tiziana is exploring something new towards the more general conjecture about cyclic quadrilaterals (C7)</b>	

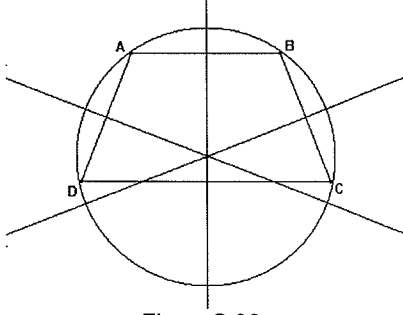
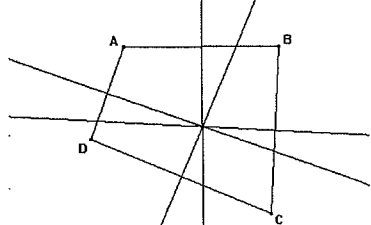
			364. Tiziana takes the mouse and goes to "circle". She tries to make a circle with the centre in the intersection of the perpendicular bisectors (FigureC.36)
			 <p>FigureC.36</p>
			365. Tiziana: right!
1.09.52	366. Bartolomeo: I don't understand why you did that		
			367. Tiziana is about to draw another circle by mistake. Bartolomeo helps her to delete. Then Tiziana drags B around by chance.
	368. Bartolomeo: take out the circle... do this, take the circle out		
			369. Tiziana: no, wait, I did it wrong!... no, nothing, I wanted to do ...
			370. Tiziana intersects the circle with all the sides of ABCD
1.10.30	371. Bartolomeo: I don't understand what you want to do!		
			372. Tiziana drags the circle to enlarge it, probably thinking that the quadrilateral is enlarged too, but the quadrilateral doesn't move
			373. Tiziana: ok... ehm...
1.11.29	374. Bartolomeo: grab the circle!		
			375. Tiziana: no, wait...
			376. Tiziana opens a new file, draws the quadrilateral again, then the perpendicular bisectors. Then she drags a vertex so that they coincide (FigureC.37)
			 <p>FigureC.37</p>
	377. Bartolomeo: we want to see if ... make it big, so that the intersections can be seen well... why are you doing this?		
			378. Tiziana select "circle" again and wants to take the centre in the intersection of the perpendicular bisectors but she gets it wrong as before
	379. Bartolomeo: what do you want to do?		
			380. Tiziana succeeds in finding the centre of the circle and draws the circle so that ABCD looks cyclic
1.12.10			381. Tiziana: how can I do ... to link it?
	382. Bartolomeo: eh? ... you must go to		

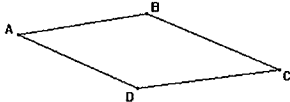
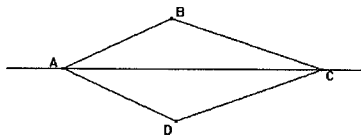
	"point on object"		383. Tiziana selects "point on object" and click on A
	384. Bartolomeo: ... but it gives you only one point, because it goes on the circle. In fact if you go to "which object"...		
1.12.42			385. Tiziana: I mean but there is no point ...
	386. Bartolomeo: look...		
	387. Bartolomeo takes the mouse		
	388. Bartolomeo: you put it, but the only problem is ...		
	389. Bartolomeo drags the circle to make it smaller, and then the point Tiziana that he linked to the circle, moving it on the circle		
			390. Tiziana: so how can you attach it?
	391. Bartolomeo deleted the linked point and drags the circle to make it bigger		
		<b>c. the case of the rhombus (C4)</b>	
		392. O: do you have another conjecture?	
	393. Bartolomeo: eh... no, in fact I don't know ... so let's do this		
1.13.20	394. Bartolomeo closes this file (FigureC.37) and the previous one (FigureC.36), going back to the right angled trapezium (FigureC.32)		
			395. Tiziana: again?
1.14.26	396. Bartolomeo: yes, we can just modify the figure. So we need to prove the rhombus, right? So let's prove the rhombus (drags B)... however this one was not ready... let's do another one!		
			397. Tiziana: no, wait, let's get this one finished
	398. Bartolomeo: but we are stuck, it's better to do something else. Then maybe we can do this....So we reduce this as an icon ...		
1.15.06	399. Bartolomeo reduces this figure as an icon and draws a quadrilateral on another file, doing it very quickly and wrong. Finally he succeeds in drawing the quadrilateral and drags the vertices to get a rhombus (FigureC.38).		
	 <p>FigureC.38</p>		
	400. Then he draws the bisector of angle A and drags the point so that C belongs to the bisector (FigureC.39)		
	 <p>FigureC.39</p>		
			401. Tiziana: put the trapezium back again...
	402. Bartolomeo: wait... do you have		

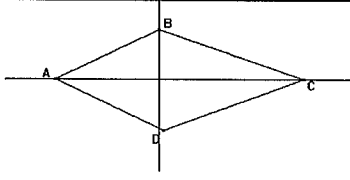
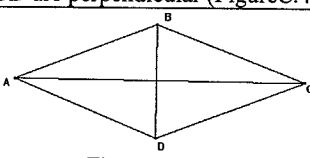
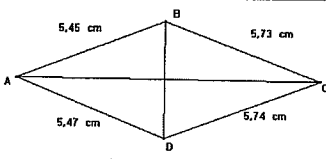
	<i>any idea?</i>		
			403. Tiziana: <i>no, I mean... eh, the stuff, the sides must be equal!</i>
	404. Bartolomeo: <i>I know, just a moment, I just need to ...</i>		
	405. Bartolomeo drags B and D trying to get equal sides		
			406. Tiziana: <i>look, let's do this ...</i> (Tiziana takes the mouse and draws the perpendicular line to the bisector of angle A and going through B– FigureC.40)
			 <p style="text-align: center;">FigureC.40</p>
1.16.45	407. Bartolomeo: <i>do only the segments and the diagonals</i>		
			408. Tiziana draws the segments from A to C, and from B to D
			409. Tiziana: <i>look what a mess!</i>
	410. Bartolomeo: <i>it doesn't matter. Now delete ...</i> (points with his finger on the screen)... <i>the line</i>		
			411. Tiziana hides the line perpendicular to the bisector of A going through B and the bisector
1.17.16	412. Bartolomeo: <i>now go to... to pointer...</i>		
			413. Tiziana deletes the segment BD
			414. Tiziana: <i>why are there two points here?</i> (pointing at B with the mouse)
	415. Bartolomeo: <i>because... delete one of them... wait... excuse me...</i>		
	416. Bartolomeo takes the mouse and deletes the extra point. Then he draws again the segment BD		
	417. Bartolomeo: <i>it must be perpendicular...</i>		
			418. Tiziana: <i>couldn't you do the perpendicular line?</i>
	419. Bartolomeo: <i>wait...</i>		
1.18.31	420. Bartolomeo drags B so that AC and BD are perpendicular (FigureC.41)		
	 <p style="text-align: center;">FigureC.41</p>		
1.19.07	421. Bartolomeo: <i>is that all right?... now in order to be sure we can do ... "distance and length"...</i>		
	422. Bartolomeo puts measurements for the sides of the quadrilateral ABCD (FigureC.42)		
	 <p style="text-align: center;">FigureC.42</p>		
			423. Tiziana: <i>yes, they're all correct, sure!</i>

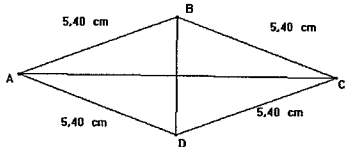
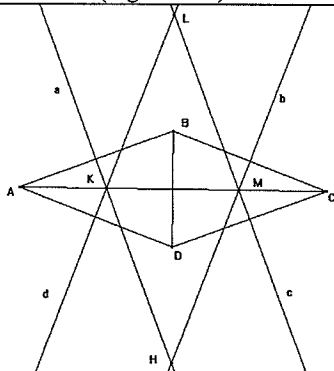
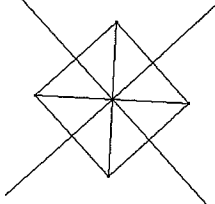
	424. <i>Bartolomeo: don't worry! We just need to move them!</i>		
	425. Bartolomeo drags C in order to get equal sides		
			426. <i>Tiziana: right, but this one...</i>
	427. <i>Bartolomeo: don't worry... well, at least the one down here is correct (he's dragging C slowly)</i>		
1.20.00	428. Bartolomeo drags B, with the same modality, then C and then D, getting a rhombus with sides 5,40cm length (FigureC.43)		
	 <p>FigureC.43</p>		
	429. <i>Bartolomeo: ok, done, I got it!</i>		
	430. Bartolomeo deletes measurements		
	431. <i>Bartolomeo: ok, now we have a rhombus</i>		
			432. <i>Tiziana: you must draw the perpendicular bisectors!</i>
1.21.01	433. <i>Bartolomeo: eh, just a moment</i>		
	434. Bartolomeo draws the perpendicular bisectors of the sides of the rhombus (FigureC.44)		
	 <p>FigureC.44</p>		
	435. <i>Bartolomeo: why is it so big?</i>		
	436. Bartolomeo marks the intersection points to get HKLM		
	437. <i>Bartolomeo: did he mark it?</i>		
1.21.54	438. Bartolomeo goes left to see the bit of the drawing which is outside the visible part of the screen		
			439. <i>Tiziana: yes, but what's that?</i>
	440. <i>Bartolomeo: well, it's a bit big! ... so ... a rhombus is formed ... then...</i>		
			441. Meanwhile Tiziana drew a rhombus on paper with the perpendicular bisectors meeting in the intersection point of the diagonals (see the sketch in FigureC.45)
			 <p>FigureC.45</p>
	442. Bartolomeo draws the bisector of the angle KHM		

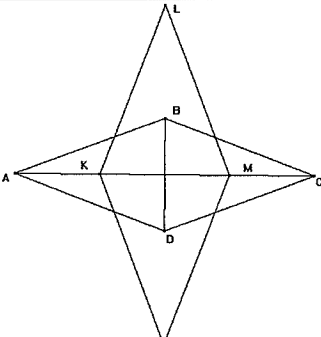

	443. Bartolomeo: so we found that a rhombus is formed ... look, look there, we can see it quite well ... just a moment, I still need to...		
	444. Bartolomeo draws the segments linking H, K, L and M, and then hides the perpendicular bisectors (FigureC.46)		
	 <p>FigureC.46</p>		
			445. Tiziana: what's that?
1.22.50	446. Bartolomeo: well we have 2 rhombi... and the diagonals, the 2 diagonals coincide ... then...		
			447. Tiziana: this is parallel to that (points with fingers at KL and HM), this is parallel to this (points at LM and KH)
	448. Bartolomeo: yes, that's obvious		
			449. Tiziana: so they are 2 rhombi!
		<b>d. proving the case of the rhombus (P4)</b>	
	450. Bartolomeo: we need to prove that... ah, that's right!.... You said that this is parallel to that (points at LM and KH with the mouse)... or, sorry, we should prove that the sides are equal, shouldn't we? And that then ... we can prove that this triangle (points at LOM) equals that one (LOK), so also this (LK) equals that (ML)...		
1.23.40		451. 30 seconds of silence	
	452. Bartolomeo: this is right (points at the angle LOM with the mouse)...		
			453. Tiziana: yes, this is right, yes, so, well, this equals that (points at KO and OM quickly on the screen with a pen)
	454. Bartolomeo: then, this is...		
			455. Tiziana: this is in common (points at LO)...
	456. Bartolomeo: ...then this is the bisector, because I did it ... so...		
			457. Tiziana: right, so what?
	458. Bartolomeo: ... this is an isosceles triangle (points at triangle LKM), because if this (LM) equals that (KL)... so we proved that that one is a rhombus.... Now what can we find? Let's prove that...		
		459. 30 seconds in silence	
	460. Bartolomeo: shall we use another figure? Here we proved it is a rhombus. Ah, we could prove that maybe... well, let's see...		
		461. O: what do you want to prove now?	
1.24.36	462. Bartolomeo: no, but... I don't		

	<i>know, I want to try and see if maybe they are similar ...</i>		
		<b>C.2.9 Episode 9. Formulating a general conjecture about cyclic quadrilaterals (C7)</b>	
		463. O: <i>but the one you had before, of the perpendicular bisectors meeting at a point?</i>	
			464. Tiziana: <i>which one?</i>
	465. Bartolomeo closes FigureC.46 and opens again FigureC.32		
		466. O: <i>the one you did before, where the perpendicular bisectors were ...</i>	
	467. Bartolomeo: <i>yes, we proved that already!</i>		
		468. O: <i>have you got a proof already?</i>	
	469. Bartolomeo: <i>yes</i>		
			470. Tiziana: <i>which one, the one ...the square?</i>
	471. Bartolomeo: <i>the one of the rectangle! Yes</i>		
			472. Tiziana: <i>ah yes, we proved that</i>
		473. O: <i>not the one of the rectangle</i>	
	474. Bartolomeo: <i>the one... that the perpendicular bisectors...</i>		
			475. Tiziana: <i>ah, the trapezium, where they met at a point? The one we closed!</i>
	476. Bartolomeo: <i>is it this one? (points at FigureC.32)</i>		
			477. Tiziana: <i>no, no, wait, give me! We closed it!</i>
		478. O: <i>did you close it?</i>	
			479. Tiziana takes the mouse, closes FigureC.32 and opens a new file
	480. Bartolomeo: <i>which one was it?</i>		
			481. Tiziana: <i>the one about the circle!</i>
			482. Tiziana draws a circle
	483. Bartolomeo: <i>ah...</i>		
			484. Tiziana: <i>so...</i>
	485. Bartolomeo: <i>but ...excuse me...don't... what did you do?</i>		
1.26.11			486. Tiziana has just started to draw a circle with centre in a point of the other circle
	487. Bartolomeo: <i>do "delete", you highlight it and do "delete"</i>		
			488. Tiziana: <i>there is only one point</i>
	489. Bartolomeo: <i>and... you put 2.... But it's not... sorry, let's do this...</i>		
			490. Tiziana: <i>it's the one...</i>
1.28.05	491. Bartolomeo: <i>but we proved they meet.... No, we proved that if it is a rectangle or a square the perpendicular bisectors meet at a point: if it is a parallelogram or a trapezium or a rhombus ... depending on ...</i>		
			492. Tiziana: <i>if it is an isosceles trapezium... if the trapezium is isosceles, they meet at a point again</i>
	493. Bartolomeo: <i>yes</i>		
			494. Tiziana: <i>so... (Tiziana goes to</i>

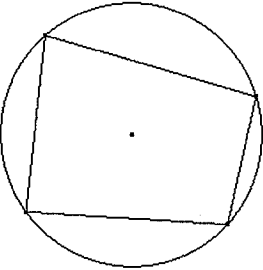
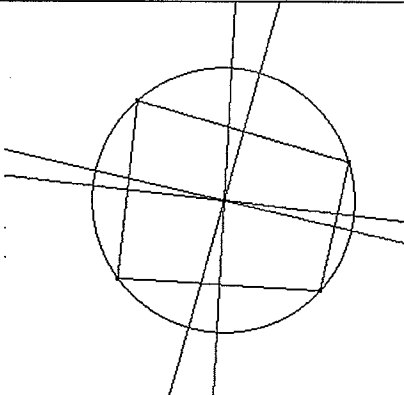
			"point" and is about to draw four points on the circle. Then she deletes them)
	495. <i>Bartolomeo: what do you want to do? Do you want to do a trapezium? Do you want to do a quadrilateral?</i>		
	496. <i>Bartolomeo takes the mouse</i>		
	497. <i>Bartolomeo: so let's do this: "point on object" ... we attach them here ... (Bartolomeo puts 4 points on the circle)... then "segment" (constructs the four segments – FigureC.47). You see? Making this bigger (Bartolomeo drags a point of the circle) this gets bigger or smaller, right? This is what we wanted. Then ...</i>		
	 <p>FigureC.47</p>		
	498. <i>Bartolomeo draws the perpendicular bisectors of the sides of the quadrilateral (FigureC.48)</i>		
	 <p>FigureC.48</p>		
1.29.07			499. <i>Tiziana: when the quadrilateral is cyclic, the things meet at a point</i>
	500. <i>Bartolomeo: yes, the perpendicular bisectors meet at a point ... but now we should prove it: this is the worst part. So "intersection of 2 objects"</i>		
	501. <i>Bartolomeo first goes to "intersection of 2 objects", try to intersect the lines, then drags one vertex linked to the circle</i>		
	502. <i>Bartolomeo: anyway it's always a point</i>		
			503. <i>Tiziana: ... when it's cyclic. So when... how's the... if it is cyclic the sum of the, the opposite angles ... is it that one?</i>
	504. <i>Bartolomeo: uh yes, opposite angles</i>		
			505. <i>Tiziana: and how much is it?</i>
	506. <i>Bartolomeo: if I don't go wrong it's...</i>		
1.29.53			507. <i>Tiziana: yes, when the sum of the</i>

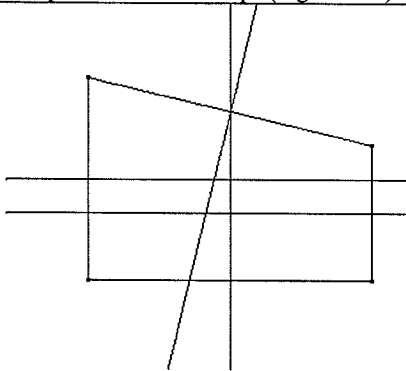
			<i>opposite angles is 180°... then it is one point (uses his hands to reproduce the opposite angles and the intersection with the perpendicular bisectors)</i>
	508. Bartolomeo: <i>it was not opposite angles... equal angles...</i>		
			509. Tiziana: <i>when the angles... no, well, are...</i>
	510. Bartolomeo: <i>ah no, the sum of the opposite angles equals ...</i>		
			511. Tiziana: <i>the sum of the opposite angles equals 180°... the perpendicular bisectors meet at a point</i>
	512. Bartolomeo: <i>yes, in fact also the rectangle and the square the sum of the opposite angles is 180</i>		
	513. Bartolomeo keeps dragging a vertex of the quadrilateral		
1.30.54	514. Bartolomeo: <i>ok, so we leave this</i>		
	515. Bartolomeo reduces FigureC.48 as icon		
			516. Tiziana: <i>we're finished!</i>
	517. Bartolomeo: <i>we can close it then!</i>		
		<b>C.2.10 Episode 10. Concluding with a general conjecture (C9)</b>	
	518. Bartolomeo opens again FigureC.46		
	519. Bartolomeo: <i>first conclusion: if the sum of opposite angles is 180, then they meet at a point. Then ... let's see... I want to try something</i>		
1.32.03	520. Bartolomeo reduced FigureC.46 as icon, opens a new file and starts to construct a quadrilateral		
			521. Tiziana: <i>what are you doing?</i>
	522. Bartolomeo: <i>I'm moving it randomly, then I take the perpendicular bisector ...</i>		
	523. Bartolomeo draws the perpendicular bisectors of the sides which meet at a point		
	524. Bartolomeo: <i>... we just need to make it bigger...</i>		
	525. Bartolomeo drags two vertices of the quadrilateral and stops (FigureC.49)		
			
	FigureC.49		
		526. O: <i>what do you want to see?</i>	
	527. Bartolomeo: <i>I wanted to see something: that if the sum of the opposite angles we said is 180, then the perpendicular bisectors meet at a point;</i>		

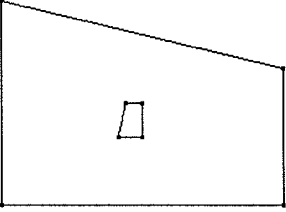
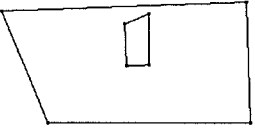
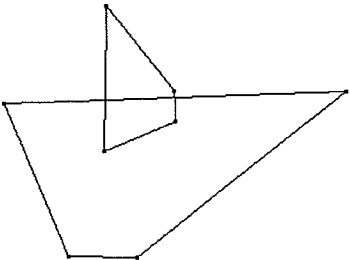
	<i>if on the contrary the sum is not 180, an equal quadrilateral appears...</i>		
			528. Tiziana: not equal, similar!
	529. Bartolomeo: <i>eh, similar to the given one!</i>		
	530. Bartolomeo marks the intersections of the perpendicular bisectors and then draws the segments to get the internal quadrilateral: then he hides the perpendicular bisectors (FigureC.50)		
	 <p>FigureC.50</p>		
	531. Bartolomeo: <i>look....So this is similar ...</i>		
1.33.10	532. Bartolomeo drags a vertex (FigureC.51)		
	 <p>FigureC.51</p>		
	533. Bartolomeo: <i>... if we put it like that it's similar...</i>		
	534. Bartolomeo drags another vertex (FigureC.52)		
	 <p>FigureC.52</p>		
	535. Bartolomeo: <i>... if we put it like that it's similar. They are always similar! So...the conclusion is...</i>		
			536. Tiziana: <i>excuse me, eh</i> (she touches the segments of FigureC.52 in order to understand the similarity)
	537. Bartolomeo: <i>yes, turn it like that</i> (with his hand he makes a move to rotate the quadrilateral to a position where it's easier to see the similarity between the external and the internal quadrilateral)		
1.34.03	538. Bartolomeo: <i>so, without examining the particular cases, we saw that: if the sum of the opposite angles is</i> (he writes it down) <i>... equals 180°...</i>		

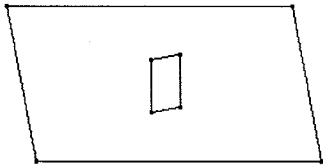
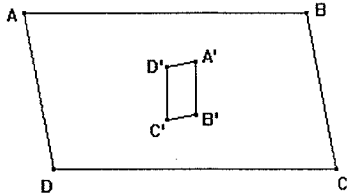
			539. Tiziana: then there is a point
	540. Bartolomeo: ... then the perpendicular bisectors meet at a point		
			541. Tiziana takes the mouse and drags the vertices randomly, then drags a segment
	542. Bartolomeo: ... if the sum of the opposite angles is different from 180, then there is a figure similar to the given one .... So we have the proof of this in the case of ... (closes FigureC.52 and opens again FigureC.46)... eh... what's this? No... (closes and opens FigureC.32)... we deleted it!...		
			543. Tiziana: ah, that one again!
1.35.09	544. Bartolomeo: we must find one case... we must prove that in any case they are similar. We could also take that one... yes, something that is not too difficult (Bartolomeo closes FigureC.32 and opens FigureC.52)		
			545. Tiziana: what's this?
	546. Bartolomeo: the one we had before		
1.36.25	547. Bartolomeo drags the vertices to get a trapezium		
	548. Bartolomeo: ah, yeah if it is isosceles!... sure, the sum is 180°.... So, let's make a parallelogram		
			549. Tiziana: again?
	550. Bartolomeo drags the vertices and stops in FigureC.53		
	 <p>FigureC.53</p>		
	551. Bartolomeo: well, did we prove that this is a parallelogram? (points with the mouse at the internal quadrilateral)		
			552. Tiziana: yes!
	553. Bartolomeo: then we must prove that they are similar ... so that our ...last sentence ... makes sense .... So this is a parallelogram... so...		
	554. Bartolomeo goes to "names" and Tiziana puts the names for the vertices		
	555. Bartolomeo: no, do this. Put A' ... no, now I tell you which one it is: this one is ... C' ... C' you must name it		
			556. Tiziana writes A', B', C', and D' for the internal quadrilateral (FigureC.54).
			

			FigureC.54
	557. Bartolomeo takes the mouse and draws the line parallel to AD going through B. Then he drags C until the segment BC is on that line. Then hides the line.		
	558. <i>Bartolomeo: ok, this is really a parallelogram... now...</i>		
		559. Silence for one minute	
			560. <i>Tiziana: ... so they are similar!</i>
	561. <i>Bartolomeo: sure!</i>		
			562. <i>Tiziana: so if they are similar fine!</i>
	563. <i>Bartolomeo: no!...no! why are you closing it!</i>		
			564. <i>Tiziana: eh, I didn't want!</i>
			565. Tiziana closes the figure down
	566. <i>Bartolomeo: so, well, we proved this... of that...</i>		
			567. <i>Tiziana: what the hell have you done?</i>
	568. <i>Bartolomeo: I closed it... we don't need it... we proved everything. So it equals 180° and so they meet at a same point and we did the proof for this with the rectangle</i>		
			569. <i>Tiziana: yes, and then making it cyclic</i>
	570. <i>Bartolomeo: (writes down) proof with a rectangle and with a cyclic quadrilateral ... the second, we did it with the parallelogram</i>		
			571. <i>Tiziana: so if the sum is different from 180°...</i>
	572. <i>Bartolomeo: yes, I wrote it down, it is a figure similar to the given one. And this proof ...</i>		
		573. <i>O: do you want to add anything?</i>	
	574. <i>Bartolomeo: no... we did it with the parallelogram. Done!</i>		

B-T

Esercitazione in laboratorio, 16-2-2000

Sia dato un quadrilatero ABCD. Tracciate gli assi  $a$  del lato AB,  $b$  del lato BC,  $c$  del lato CD,  $d$  del lato DA. Sia H il punto di incontro degli assi  $a$  e  $b$ , K il punto di incontro di  $a$  e  $d$ , L il punto di incontro di  $c$  e  $d$ , M il punto di incontro di  $c$  e  $b$ . Studiare come varia HKLM al variare di ABCD. Dimostrate le congetture prodotte durante l'esplorazione fatta in Cabri.

- 1) Se ABCD è un parallelogramma allora anche HKLM è un parallelogramma degli assi
- 2) Se " è un rettangolo allora HKLM è un punto  
quadrato
- 3) Se " è un rombo allora anche HKLM è un rombo  
non si incontrano in un unico punto
- 4) Se " è un trapezio " è un trapezio  
non è isoscele si incontrano in un unico punto

$$\begin{aligned} \hat{K} &= \hat{KHM} \\ \hat{H} &= \hat{LKH} \end{aligned} \quad \hat{LKH} + \hat{KHM} = 180^\circ$$

$$BA:HK = AS:HM = BC:KL = CD:LM$$

$$\hat{SAB} = \hat{HAM} = 90^\circ$$

$$\hat{ABB} = \hat{HKN} \text{ perché } \hat{BKN} = 90^\circ$$

$$\hat{B} = 90^\circ$$

EC // F

$$\hat{CBD} = \hat{BKH} \text{ perché alterni interni}$$

$$\hat{HKN} = \hat{ABB}$$

$$\hat{MKL} = \hat{CBD} \text{ perché } \hat{B} \text{ e } \hat{K} = 90^\circ \text{ formati da angoli uguali}$$

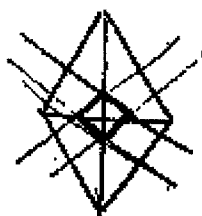



Esercitazione in laboratorio, 16 - 2 - 2000

Sia dato un quadrilatero ABCD. Tracciate gli assi  $a$  del lato AB,  $b$  del lato BC,  $c$  del lato CD,  $d$  del lato DA. Sia H il punto di incontro degli assi  $a$  e  $b$ , K il punto di incontro di  $a$  e  $d$ , L il punto di incontro di  $c$  e  $d$ , M il punto di incontro di  $c$  e  $b$ . Studiare come varia HKLM al variare di ABCD. Dimostrate le congetture prodotte durante l'esplorazione fatta in Cabri.

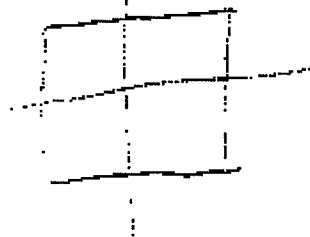

$AB \rightarrow a$   
 $BC \rightarrow b$   
 $CD \rightarrow c$   
 $DA \rightarrow d$

1) Se la somma degli angoli opposti  $= 180^\circ \Rightarrow$  gli assi si incontrano in un unico punto

2) Se la somma degli angoli opposti  $\neq 180^\circ \Rightarrow$  si ha una figura simile a quella di pentone

1) Dimostrazione con un rettangolo e con un quadrilatero inscritto

2) Dimostrazione con il parallelogramma

**APPENDIX D. TABLE OF ANALYSIS FOR TWO EPISODES OF  
THE TRANSCRIPT OF BARTOLOMEO AND TIZIANA (CASE 1)**

The table below shows one of the representations used for the analysis of the transcript. Each column accounts for a category and the numbers on the left refer to lines of the transcript. On the course of the analysis relevant information are written in the cells and preliminary hypothesis are formed and written at the end.

	EVENTS	TYPES OF STATEMENTS	DRAGGING	STUDENT-STUDENT INTERACTION	INTERPLAY SG AND T
<b>Episode 2. Starting to explore. The parallelogram (C1)</b>					
49.	After finishing the Cabri construction B suggests to move the figure. T seems reluctant to do this at first. She seems to pay a lot of attention to the appearance of the figure first. But then she follows what B is saying and starts moving the point D randomly on the screen.	GA	B wants to do dragging (#49-#50).	B has a strategy in mind and wants to move (#49). While T wants to make the figure 'perfect' before moving (#50).	
50.		GA			
51.		GA- Generative action: <i>try to move (#51)</i> : it is the starting point of the exploration.			
52.			Wandering dragging very fast (#52) with no strategy yet.	T starts moving in #52, accomplishing B's wish.	
53.		GA		B continues to think about his own strategy which he has not made explicit yet (#53).	
54.		D		T is thinking about something on her own. She is looking at the Cabri figure and 'reading' it (#54).	
55.		GA	They hide the bisectors (#55, #56). This is a crucial point as from now on the construction that links the two quadrilaterals is no longer visible. Two things may happen: either it is completely forgotten or it is kept in mind and used (see HYP 5).		
56.					

57.		GA - Generative action (#57).			B makes explicit what he wants to do (#57).	
58.			Guided dragging (#58).		T follows what B says but without seeming to understand where he wants to go (#58).	
59.		D				PERCEPTION
60.		GA			B makes explicit the general strategy he has in mind, that is an ordered exploration of cases (#60): what happens to HKLM when ABCD is a...?	
61.		GA			This time T does not pay attention to what B says and pursue her own idea ( <i>wait</i> - #61), without talking B through it. They are going along two different paths, they have different strategies'. There is asynchrony: both have ideas so who has got the mouse leads the situation.	
62.			Guided dragging very slow (#62). She knows what she wants to get, i.e. a parallelogram. Then she stops.		She has got the mouse and she does what she wants (#62), forcing B to follow her in her thoughts.	
63.		D			B is surprised to see a parallelogram (#63) on the screen because he does not know what T wants to achieve.	
64.			Stop (#64)		It is only when dragging is stopped (#64) that the two students produce a conjecture about the same thing.	

65.	C1: if $ABCD$ is a parallelogram then this is a parallelogram too.	L		At this point (#65-#66) the students are synchronised after a whole episode in which they are not synchronised (#49-#64). The synchronisation seems to take place around the figure of the parallelogram. It is a visual element, not a spoken one that provides synchrony. There is no need of speaking at this point, everything happens around a Cabri figure which now has a shared meaning. A conjecture can so be produced by both the students at the same time (#65-#66).	Both the students formulate the conjecture about the parallelogram looking only at one figure. They do not move $ABCD$ any longer before being sure that the fact that if $ABCD$ is a parallelogram then $HKLM$ is a square is a general fact. It is a perceptive observation.
66.		D De-temporalised (#65-#66).			
67.	B is aware of the difference between conjectures and proofs. As soon as they formulate the conjecture about the parallelogram he says that of course it has to be proven still (#67).	L		Actually it seems that B is following his thinking (#65-#67) and does not really interact with Interaction between the two students happens on the Cabri figure only <sup>1</sup> .	Writing has the function of fixing the conjecture (#68).
68.	The first conjecture is written down, just after having been discovered.	Logic function (#68) for the written conjecture.			
<b>Episode 3. Exploring. The point (C2) and the trapezium (C3)</b>					

69.	<p>T, who has the mouse, does what she wants, moving from (#69) to (#78) via (#75). From #69 to #93 they explore the case when there is a point inside.</p>		<p>This episode of dragging (#69 - #79) is observed in two different ways. B pays attention only to the initial and final figure), as two snapshots (photo-dragging), as his aim was very clear to him: checking if HKLM is always a point when ABCD is a rectangle (This always means for him checking in two cases). As soon as T stops in the middle figure he formulates the conjecture (#78).</p>	<p>T decides what to do because she has the mouse and does not make explicit her ideas to B (#69-#70). See HYP 4. B know what he wants to do, while T does not have a clear strategy in mind so she needs to slow down in order to experience the situation in Cabri.</p>	
70.		D	<p>On the contrary T is observing the film (film-dragging), i.e. she is observing the figure over the dragging, 'reading' what the figure suggests. She pays attention in particular at the relationships within the figure (she sees a relationship between the side of ABCD and of HKLM). In a sense she is so 'dragged by dragging': she observes the figure while moving and stops when she sees something interesting</p>	<p>B does not follow T and does not understand why she made a rectangle (#70), but then he tries to work on what he is presented with (#72).</p>	
71.					
72.		<p>D-It is a point (#72) means that in this case, for this particular configuration, it is a point. GA- Generative action: <i>try to make it bigger</i> (#72) driven by a precise aim.</p>			<p><i>Try to make it bigger</i> (#72) sound like a request for a zoom in. It seems B wants to control that it does not seem a point only because the figure is small. Perception of a static figure does not provide enough information. There is the need of dragging.</p>
73.					

74.		GA- Generative action function ( <i>just dragging- #74</i> ) which leads towards the generality.	B wants to do dragging in order to see more cases.		
75.			She stops in #75 and 'reads' a relationship between the sides of the two quadrilaterals. She is concentrated on what changes according to what. She will go back to this observation later in the process until she will transforms it into a conjecture and tries to prove it. See HYP1.		
76.		D			
77.		GA- B translates what dragging means: seeing more cases (#77).			
78.					

79.	<p><i>When it's a rectangle it is always a point.</i> B formulates the conjecture for the rectangle (#79).</p>	<p>L- B says <i>It's always a point</i> (#79). The word <i>always</i> is needed to construct generality. The language B uses contains temporal referents (<i>while</i> in the previous conjecture concerning the parallelogram there were not), and it seems to crystallise the movement of the figure, which allowed him to see that regularity. Interesting question the one he asks in #79: <i>disappears</i> is still linked to the Cabri experience of the figure that changes, it reveals an action over time. On the contrary <i>it's a point</i> is the result of the action. A de-temporalisation has occurred from the one expression to the other.</p>			
80.	<p>T observes (#80) that there are other positions for which H, K, L and M coincide. But B does not pay attention. It is the first line in which the possibility of a more general conjecture arises. C2: <i>if it is a rectangle it is a point.</i> B writes down his original conjecture (#81).</p>	<p>D- <i>Now</i> (#80) indicates the presence of time.</p>	<p>She shows him with a brief lieu muet dragging that there are other quadrilaterals for which HKLM is a point (#80)</p>	<p>T seems to abandon her line of thoughts and follows B. There is synchrony (#80).</p>	
81.		<p>L- Here is the conjecture expressed in the form 'if...then'. The word <i>always</i> is no longer present because the generality has already been constructed so now B uses the standard form 'if...then'. To what extent does the didactical contract influence the use of the standard form for conjectures?</p>	<p>Also in #81 T observes the film, thinking back to what she said in #75.</p>		



82.				T does dragging (#82), fast but slowing down when H, K, L, M happen to coincide. It seems to be a checking of what she has just said (#80) about other positions creating a point.		
83.		GA			In #83 B wants the mouse back. He needs this to get control over the situation. Every small movement seems to be important in this situation <sup>iii</sup> . B needs the mouse to go on with his own rhythm. B takes the mouse (#84-#98).	
84.				Guided dragging (#84).		
85.		GA		Descending interaction with Cabri (#85): B says what he wants to do first and then does it in Cabri. Stop (#86).		
86.						
87.						
88.				Guided dragging (#88): a square.		
89.		D		Non linear language (#89).	B is at the theoretical level, he is asking why something is happening (square and point), while the conjecture about the rectangle was coming from a perception only.	
90.	C2	L				

91.	T makes a sketch on paper (#91). D			The fact T goes on paper is due to the fact that B does not listen to her (#87) and she does not have the mouse so that she needs to find another space to manipulate the figure.	The sketch has a different function from the Cabri figure, it serves as a support when they are working at a theoretical level. T sees the proof (#92) on the sketch. B sees the proof as well (#93) but he does not make it explicit yet <sup>v</sup> .
-----	------------------------------------	--	--	---	--

<sup>i</sup> General comment (D + contribution of Cabri to the process). All over the transcript B and T show two different solution strategies that correspond to two different uses of Cabri in terms of dragging and control over the software:

1. B has some ideas in mind and wants to try them out in Cabri: ideas come first and then action. For example he suggests an ordered exploration of cases, or checking a conjecture in Cabri etc. A descending process is prevailing. He seems not to be absorbed by the software. Cabri becomes immediately part of his internal space as an external means which is dominated by B. The exploration of the situation seems to be quite structured and in his mind.
2. On the contrary it seems that T is more 'involved' into Cabri. With a metaphor we can say 'she is dragged by dragging', in that she reads what is happening in Cabri while she is dragging. For example while she is trying to get a trapezium, as B suggested, she stops on the parallelogram. She follows carefully the figure while she is dragging and stops whenever she sees something interesting. An ascending strategy is prevailing. She seems to be completely absorbed by the software. T uses Cabri in order to explore the situation and get ideas about it.

<sup>ii</sup> Hypothesis (Te). The possibility of direct manipulation of Cabri objects through the mouse makes Cabri an external space in which the two subjects can interact and communicate, trying to synchronise their internal S-T. If they were working with paper & pencil, the synchronisation would be much more difficult, and probably it would not happen at all: the manipulation of a paper drawing done by someone else is nearly impossible. With paper & pencil, even if the subjects work together on the same problem, a real interaction and collaboration is not possible, as it is not possible for them to construct and modify the external space at the same time.

<sup>iii</sup> Hypothesis. The mouse let you in the Cabri space-time. The mouse is needed in order to manage the situation and to have a direct Cabri experience. This might be much more important when the internal S-T is not completely constructed yet, and the students need to do physical experiments rather than mental ones. Can we talk about embodiment?

When B does not let T have the mouse back, she draws on paper, as if she needs a physical experience anyway, and since she cannot get the mouse she finds herself another space-time. The figure on paper seems to be only a support to her theoretical considerations.

<sup>iv</sup> Hypothesis. The sketch seems to constitute a proof itself. It has a different status from the Cabri figure, it is at a more theoretical level.

---

## APPENDIX E. THE STORY OF DEBORA AND GIULIA (CASE 2)

### E.1 THE CONTEXT

Debora and Giulia are 15-year-old students from a second year classroom of a Liceo Psicopedagogico in Turin (Italy)<sup>1</sup>. They are medium achievers. They had used Cabri only once before this session. The problem given to the students was: Perpendicular Bisectors of a quadrilateral (see Figure E.1). The session took place on the 1<sup>st</sup> February 2000.

You are given a quadrilateral ABCD. Construct the perpendicular bisectors of its sides: a of AB, b of BC, c of CD, d of DA. H is the intersection point of a and b, K of b and c, L of c and d, M of a and d.

Investigate how HKLM changes in relation to ABCD.

Prove your conjectures.

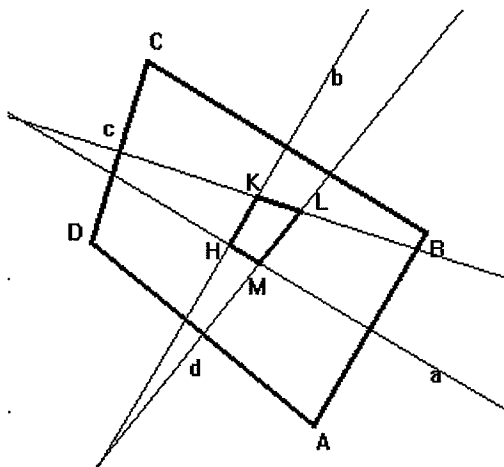

Figure E.1. D&G. Perpendicular bisectors of a quadrilateral

The students were presented with the problem and asked to formulate conjectures and try to prove them. They were given a worksheet with the statement of the problem and were required to write the conjectures down and possibly proofs as well. The session lasted 1 hour and 30 minutes. The teacher was left free to intervene and she intervened six times in the session, always in response to students' calls; however she never gave direct answers to what students asked, but discussed the situation with them. In the first intervention, the teacher made some brief clarifications about what the task the students had to tackle was; the second time she tried to make the students focus on looking at particular cases rather the most general one (similarity between the two quadrilaterals) and then she made it clear to the whole class that they were asked to formulate conjectures for particular cases and only

---

<sup>1</sup> For a detailed description of the context of the Italian setting see chapter 4 (p.74).

if possible for the general one; the third time she prompted the students to prove the conjectures they had; the fourth time she discussed with the students how they could prove that two quadrilaterals were similar; then, there is a brief discussion about the properties of a rhombus; finally there is quite a long discussion about how to prove the conjecture If ABCD parallelogram then HKLM parallelogram. The observer intervened once to prompt for reflection on an observation the students had made.

## E.2 THE PROVING PROCESS OF DEBORA AND GIULIA

This section presents the story of the solution process the students undertook, divided into episodes. The construction of conjectures and proofs will be described as they were discovered, formulated and written down. The conjectures are numbered in order of appearance as C1, C2 etc. and so are the proofs (P1 is the proof for C1, P2 for C2 and so on). All the statements which are a different formulation for conjecture Cn are named Cn. The numbers #n refer to lines in the transcript<sup>2</sup>. The description of the events is in normal Times. *The students' talk is in italics.* The written statements are in this font.

### E.2.1 Episode 1. Constructing the figure.

(#1-#83; 0.00.00-0.09.00)

The construction of the figure takes some time, as the girls seem to have problems in determining and naming the intersections of the perpendicular bisectors. They construct a first quadrilateral with the perpendicular bisectors (#1-#27), but then they delete it and start all over again because when they start naming vertices and lines they get confused about which perpendicular bisector belongs to which side of ABCD. *Giulia: but we can't see it now! (#27); Debora: ok, let's do it again (#28).* The new construction is done slowly, bit by bit. Giulia reads the text and Debora constructs the figure in Cabri (Figure E.2) following Giulia's instructor (#30-#83).

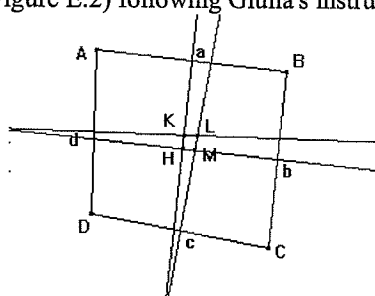

Figure E.2. D&G, Ep.1, #83

### E.2.2 Episode 2. Starting to explore. The case of the rhombus (C1) and the case of the point inside (C2)

(#84-#156; 0.09.00-0.15.40)

After constructing the figure, Debora tries to move it (#85). The girls first make some

<sup>2</sup> The numbers should help the reader to have a sense of at what time in the process things happened or were said.

observations about how the elements of the figure move. Then, a direction of exploration is put forwards by Giulia who says: *Try to make this (ABCD) a rhombus (#111)*. While Debora is moving ABCD and stops in Figure E.3, Giulia sees something else: *They all go ...try to make them coincide (#113) and then and this (ABCD) is a square, do you want to bet? (#115 -C2)*.

C1  
C2

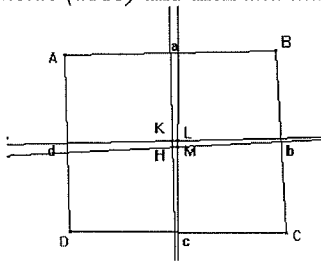

Figure E.3. D&G, Ep.2, #112

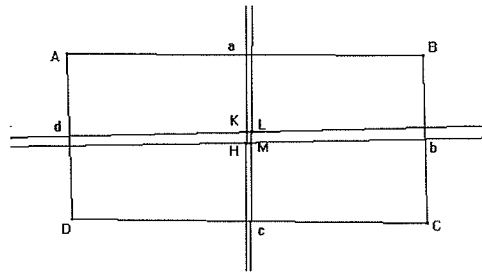

Figure E.4. D&G, Ep.2, #130

They check this observation by measuring the sides of ABCD, which tells them they are all different. Debora tries to recall what a perpendicular bisector divides (#116): *it cuts the side in a half, doesn't it?*, but Giulia does not pay attention to this remark.

They are confused about what the problem is about and what they are supposed to do: *Giulia: I don't understand...change ... I don't understand in which sense ... what it means (#120)*, so they call the teacher (#124). Debora explains on Figure E.4 what she observed: *I make a rectangle like this and here it becomes vertical (C3), I make a rhombus here like this and here it becomes like that (C1) (#131)*. The teacher explains them that this is the problem: *how one changes in function of the other one (#132) and the problem is ...that if ABCD is ...then ...isn't it? (#154)*.

C3  
C1

Meanwhile, Debora turns ABCD into a parallelogram (#133), then Giulia asks her to the rectangle again (#134). Debora wants to make a perfect square, but she can't and says that *anyway then they coincide, you can't see what's in the middle! (#148)*. Giulia draws a sketch on paper, saying : *I can't see anything ...Miss...help. Well, we can't ... I don't understand, well...I can't ... I can't find the relationship between ...(#153)*.

C6-C3  
C2



Figure E.5. D&G, Ep.2, #152

### E.2.3 Episode 3. Towards a general conjecture (C4)

(#157- #272; 0.15.45-0.32.00)

Debora sees something on Figure E.6, i.e. that *these are parallel* (the perpendicular bisectors b and d) (#158). They want to check *if they stay parallel in any case* (#159), which they do not. Debora brings theory in, asking: *is the perpendicular bisector at  $90^\circ$  with the side?* (#179). Giulia says that it is not, and then they focus on something else.

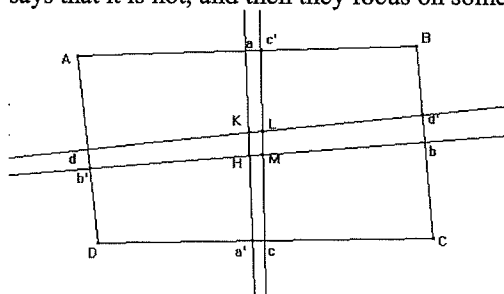

Figure E.6. D&amp;G, Ep.3, #157

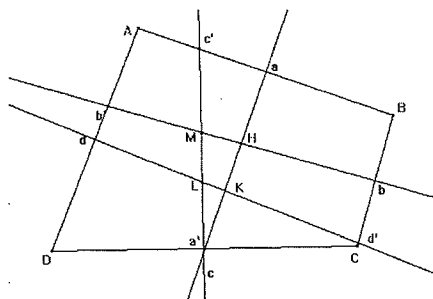

Figure E.7. D&amp;G, Ep.3, #206

Debora starts dragging CD and Giulia observes that *the figures internal to the quadrilateral, excluding HKLM, are congruent in pairs respectively* (#191), which is then repeated as *every time you rotate ABCD it always happens that the figures external to HKLM are congruent in pairs!* (#200) and *the opposite ones are congruent* (#201). Again they check the conjecture through dragging and it does not hold (#206-207 - Figure E.7).

C4

Then, they observe the different behaviour of the whole Cabri figure according to what Debora moves, either one side or one vertex of ABCD, and Debora says: *yes, it's always the same, but it is smaller and turned around* (#223-C4). Debora brings the theory in: *... isn't the perpendicular bisector that thing which ...* (draws a sketch on paper - Figure E.8). *Suppose you have a triangle here ..here you have a triangle and you have it in a mirror ...like that. So if you look at it here (points at the screen) this one (HKLM) is the image in the mirror of this one (ABCD).* (#236 - C4). The teacher tries to make them reflect on the difference between perpendicular bisector and line of symmetry and then suggests they look for particular cases.

C4

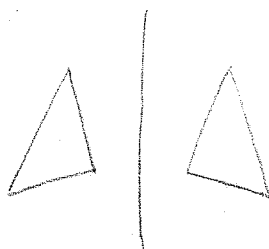

Figure E.8. D&amp;G, Ep.4, #236

#### E.2.4 Episode 4. Exploring particular cases. The case of the rhombus (C1), the case of the square (C2), the case of the rectangle (C3), the case of the trapezium (C5) and the case of the parallelogram (C6)

(#273- #334; 0.32.55-0.40.00)

The teacher tells the whole classroom that they should examine particular cases, and it is not necessary to formulate a conjecture for a general quadrilateral (#273). The girls start with a series of conjectures. **C1.** Giulia: *if the external figure is a rhombus ...* (#279) Debora: *... the internal figure is a rhombus* (#280). **C2.** Giulia: *if the external figure is a square ...* (#281), Debora: *... the internal figure is a square!* (#282). Giulia makes ABCD a sort of square (Figure E.9) and says **C2:** *if the external figure is a square, the points coincide* (#287). They discuss this conjecture because the figure on the screen does not look like a square. Then they start writing down the conjectures **C2:** If ABCD is a square, HKLM coincide (#299) and **C1:** If ABCD is a rhombus ... Debora: HKLM is a rhombus ...upside down

C1

C2

C2

(#301-302) . Then they explore other cases. **C3**. Giulia: if ABCD is a rectangle, HKLM is an upside down rectangle (#312) and she writes it down. **C5**. Giulia: (writing down) if ABCD is a trapezium, that one (HKLM), is a trapezium upside down with respect to the line of symmetry (#326). **C6**. Giulia: make a parallelogram (#329) ... The inside one is ...an upside down parallelogram (#332).

C1  
C3  
C5  
C6

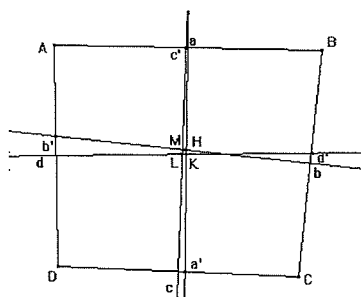

Figure E.9. D&G, Ep.4, #286

### E.2.5 Episode 5. Starting to prove. The case of the square (C2)

(#336-#436; 0.40.00-0.53.00)

They decide they have to prove the conjectures, as Giulia says: *Giulia: ...we should construct a proof for the conjectures ...* (#336). And they want to start from the square (C2). They try to make ABCD a square, by using measures, but they cannot do that very easily (#353-#399). They get to a rectangle and Debora observes (C3): *it is a rectangle and they coincide also when you have a rectangle* (#403). They keep trying to make a square but then they give up.

C2  
C3

### E.2.6 Episode 6. Proving the case of the rhombus (C1)

(#437-#503; 0.54.00-1.00.00)

The girls abandon the case of the square and start dealing with the case of the rhombus (#437 - Figure E.10). *Giulia: so, proofs. We must prove it is an upside down rhombus ...* (#442). Their attempt to proving it follows a particular path, in which HKLM is not directly taken into consideration. Giulia observes that they know that the perpendicular bisectors divide each side of ABCD into two equal parts, then she suggests *Let's start from these two big figures: this one (Ac'Ld) and this one (Ha'Cb)* (#442). Debora suggests: *let's prove that this one (ac'LK) and this one (HMca') are equal* (#443). They want to apply the criteria for the congruence of triangles (SAS) in the case of this quadrilateral for AdKa and CcMb (#457-#461). They agree on the fact that  $Aa=Ad$  and  $Cb=Cc$ . After some discussion they agree to prove that  $AaKd$  and  $MbCc$  are congruent (#497), but they do not know how to do it.

C1-P1

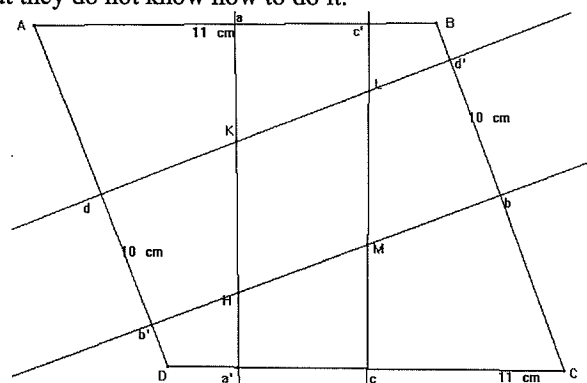

Figure E.10. D&G, Ep.6, #438

### E.2.7 Episode 7. Trying to prove the case of the parallelogram (C6)

(#504-#569; 1.00.00-1.12.05)

The girls call the teacher asking clarification about how you prove that two quadrilaterals are congruent (#504). After discussing with them, the teacher suggests that *we usually prove the congruence of quadrilaterals by dividing them into congruent triangles* (#512). Giulia remembers

what they have to prove now: *and we need to prove that this one is an upside down rhombus. What is the property of the rhombus that we need to find in order to ...*(#515). The teacher makes them reflect on the properties of a rhombus and after a brief discussion she says that *it is a parallelogram with all sides equal* (#529). The girls observe that the figure on the screen (Figure E.10) is a parallelogram, so they decide to try proving the conjecture C6 about the parallelogram instead (#535). Following the suggestion of the teacher, Giulia writes the conjecture down, distinguishing hypothesis and thesis: hypothesis: AB parallel and congruent to DC and AD parallel and congruent to BC. Thesis... KL parallel and congruent to HM (#539). First Debora observes that: *take measurements and it's correct! End of the proof!* (#547). Then they want to check if the opposite sides of HKLM are parallel and they construct a parallel line to d going through b (#552) and they see the two sides are not parallel: *why aren't you parallel?* (#555). So they check if the sides of ABCD are parallel and they are not. They conclude *it's all wrong!* (#562). As a last resort they check if the angles are congruent, and they are not (#369).

### E.2.8 Episode 8. Trying to prove the case of the parallelogram (C6) again

(#570-#690, 1.12.00-1.27.30)

The girls call the teacher (#570) because they do not know what to do, because *the fact is that ABCD is not a parallelogram* (#577). The teacher asks them if they can make it a parallelogram (#578) and suggests by showing it in Cabri, that *you can make a figure which has approximately parallel sides ...this one can do!* (#584). Debora immediately observes: *but they are not parallel ...shall we do as if they were parallel?* (#585). So they start proving the conjecture C6 (#586-690). But again they concentrate on the quadrilaterals in which the figure is split, so they do not succeed in proving the conjecture.

## E.3 SUMMARY OF CONJECTURES AND PROOFS

Table E.1 summarises the conjectures and proofs made by Debora and Giulia. The numbers refer to the lines in the transcript where the conjecture or proof was being constructed.

Conjectures	# <sup>3</sup>	#	Proofs
C1 <sup>4</sup> If ABCD rhombus then HKLM rhombus	11, 131, 279, 301-302	442, 515	P1
C2 If ABCD square, then HKLM point	113-115, 143-148, 281, 299, 346, 434		P2
C3 If ABCD rectangle, then HKLM point	130, 282, 311, 323, 401	403-406, 433	P3
C4 ABCD similar to ABCD	155, 191, 200-201, 222, 228, 235, 250		P4
C5 If ABCD trapezium, then HKLM trapezium	326		P5
C6 If ABCD parallelogram, then HKLM parallelogram	326-330, 535, 539	543, 547, 592-689	P6
C7 HKLM coincide	297		P7

Table E.1. D&G. Conjectures and proofs

<sup>3</sup> The numbers refer to the lines in the transcript. For each conjecture and proof, I identified the lines in which the students either make a statement which is related to the final conjecture or work towards proving that conjecture.

<sup>4</sup> The formulation of the conjectures is not necessarily the one made by the students.



Table E.2 below shows the proving process and how conjectures and proofs developed and interweave over time.

Ep	C1	C2	C3	C4	C5	C6	C7	#
	○							111
		○						113
		○						115
			○					130
	○							131
		○						143
		○						148
				○				155
				○				191
				○				200-201
				○				222
				○				228
				○				235
				○				250
	○							279
		○						281
			○					282
		○						287
							○	297
		○						299
	○							301-302
			○					311
			○					323
					○	○		326-329
						○		330
		○						346
			○					401
			●					403-406
			○					433
		○						434
	●							442
	●							515
						○		535
						○		539
							●	543
							●	547
							●	592-689

Table E.2. D&G. Evolution of conjectures and proofs.

○<sup>5</sup> = conjecture, ● = proof

<sup>5</sup> The symbols ○ and ● indicate either the moment in which the conjecture or proof was made or the moments in which students worked towards that conjecture or proof.

## APPENDIX F. THE STORY OF ALESSANDRA AND TIZIANA (CASE 3)

### F.1 THE CONTEXT

Alessandra and Tiziana are 15-year-old students from a second year classroom of a Liceo Psico-Pedagogico in Turin (Italy)<sup>1</sup>. They are medium achievers. They had used Cabri only once before this intervention. The problem given to the students was: Varignon's problem (Figure F.1). The session took place on the 26<sup>th</sup> April 2000.

Draw any quadrilateral ABCD. Draw the midpoints L, M, N, P of the four sides.  
Which properties does the quadrilateral LMNP have?  
Which particular configurations does LMNP assume?  
Which hypotheses on the quadrilateral ABCD are needed in order for LMNP to assume those particular configurations?

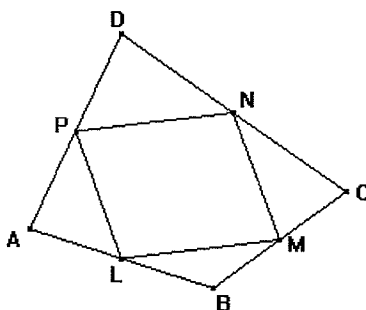

Figure F.1. A&T. Varignon's problem

The students were presented with the problem and asked to formulate conjectures and try to prove them. They were given a worksheet with the statement of the problem and were asked to write conjectures and proofs down. The session lasted 1 hour and 25 minutes. At the beginning the teacher was asked not to intervene, but then she decided to intervene when she saw that the students were stuck. She prompted the students to explore the situation freely<sup>2</sup> and to start proving if they already had conjectures. The observer intervened once to explain what was meant by the word 'configurations' and once while the students are trying to construct a square in Cabri.

<sup>1</sup> For a detailed description of the context of the Italian setting see chapter 4 (p.74).

<sup>2</sup> This was the only case in which at the beginning of the session the students were disturbed by the presence of an observer and the video-camera. However after the first half hour they forgot about this and worked more freely.

---

## F.2 THE PROVING PROCESS OF ALESSANDRA AND TIZIANA

This section presents the story of the solution process the students undertook, divided into episodes. The construction of conjectures and proofs will be described as they were discovered, formulated and written down. The conjectures are numbered in order of appearance as C1, C2 etc. and so are the proofs (P1 is the proof for C1, P2 for C2 and so on). All the statements which are a different formulation for conjecture Cn are named Cn. The numbers #n refer to lines in the transcript<sup>3</sup>. The description of the events is in normal Times. *The students' talk is in italics.* The written statements are in Courier font.

### F.2.1 Episode 1. Constructing the figure

(#1-#11, 0.00.00-0.02.45)

Alessandra and Tiziana construct a quadrilateral ABCD, its midpoints and the internal quadrilateral LMNP (Figure F.2).

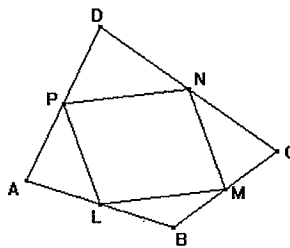

Figure F.2. A&T, Ep.1, #11

### F.2.2 Episode 2. Starting to explore. LMNP is a parallelogram (C1). LMNP rhombus (C2) and rectangle (C3). The case of the square (C4)

(#12-#59, 0.03.00-0.09.30)

Alessandra reads the problem (12), asking which properties ABCD has, and Tiziana decides to drag ABCD. *Tiziana: let's try to move it, like that ... (13).* Alessandra wants Tiziana to put measurements on the sides, since she has seen something: *try to take measurements, it seems that this one and this one are equal (points at LM and NP with her finger) and this one and this one (points at PL and MN)...* (16). After dragging, Tiziana says: *it is ... a parallelogram (19 - C1).* Then she puts measurements on the sides of LMNP (20). Alessandra writes down: opposite sides are equal (28) and parallel (29). Tiziana drags ABCD to get four equal sides for LMNP (38). Then, after reading the problem again, she says: *So... it may become a rhombus (38 - C2).* After dragging ABCD to get a rectangle inside (Figure F.3), Tiziana says: *it can be a rectangle too! (40 - C3).* At this point Alessandra suggests: *try to make this one (point with a pen at ABCD) a square. Let's see what quadrilateral it becomes (41).* Tiziana drags ABCD into a square (42- 50), looking at the measurements of the sides only. Alessandra says: *it's always the same! (53),* and Tiziana says: *it's a square... (54 - C4).* Tiziana states: *Well, we understood what it becomes! (59),* which means that they answered the first question of the problem.

C1

C2

C3

C4

---

<sup>3</sup> The numbers should help the reader to have a sense of at what time in the process things happened or were said.

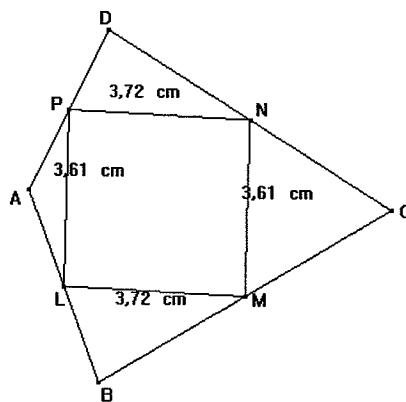

Figure F.3. A&T, Ep.2, #39

**F.2.3 Episode 3. Formulating conjectures. The case of the rectangle (C5), the case of the square (C4), the case of the parallelogram (C7), the case of the trapezium (C8)**

(#60-#116, 0.09.30-0.21.00)

Alessandra reads the second question (60). They formulate the first conjecture **C5**: *Tiziana: if ABCD... is a rectangle... (63), Alessandra: it is a rhombus LMNP (64)*, which Alessandra writes down (68) while Tiziana gets a rectangle on the screen (67). Then Alessandra suggests considering the square (68). Tiziana tries to make ABCD into a square (Figure F.4), and then they are uncertain if LMNP is a square or a rhombus. They decide it is a rhombus. *Tiziana: so, if it is a square... (69) ... Tiziana: it's always a rhombus! (80 -C4)*. Alessandra writes down C4: *if ABCD is a square then LMNP is a rhombus (81)*.

C5

C4

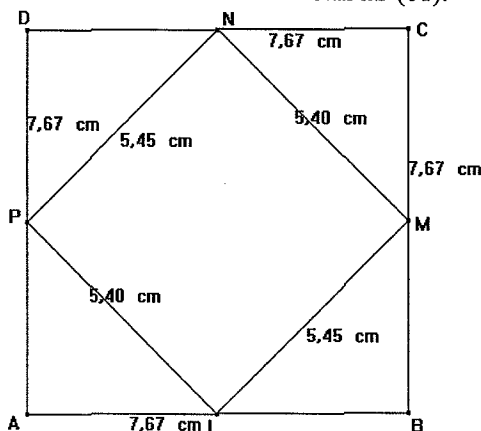

Figure F.4. A&T, EP.3, #77

After that Alessandra focuses on the rhombus: *do a rhombus... I mean, make ABCD a rhombus (82)*. Tiziana makes a parallelogram instead (83) and says **C7**: *if it is a parallelogram, it is always a rhombus inside (87)*. Tiziana then attempts to make ABCD into a rhombus, but does not succeed and gets something similar to a square instead (103), which they then recognise as a trapezium (110 - Figure F.5). Tiziana formulates the conjecture: *If ABCD is a trapezium, LMNP is ... it can be either one or the other... isn't it? It's a quadrilateral with right angles ... opposite sides parallel and congruent (114 - C8)*. Alessandra writes down what Tiziana said (115).

C7

C8

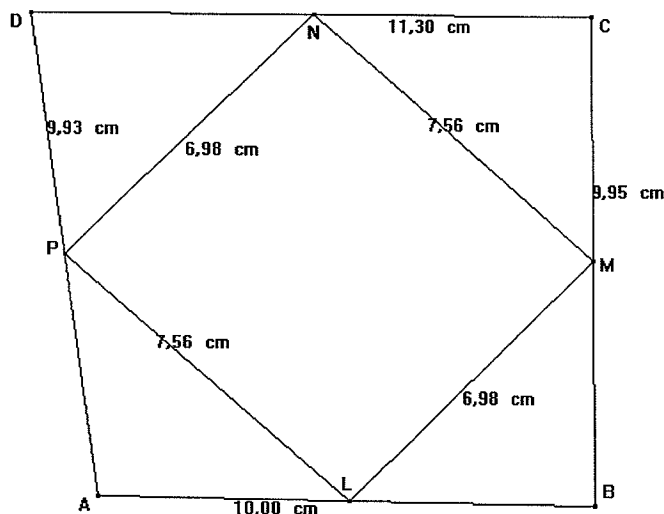

Figure F.5. A&T, Ep.3, 109

### F.2.4 Episode 4. Starting to prove conjecture C8

(#117-#175, 0.21.00-0.31.20)

Alessandra asks: *do we need to prove them now?* (118). Tiziana lets Alessandra decides which one to start from and Alessandra chooses **C8**: *let's do ... if it is a trapezium it is a quadrilateral...?* (119). They turn to paper (120). Tiziana, who has got the paper and pencil, starts drawing the square first: *I'll never be able to do that (the trapezium)! Let's start from a square* (123). After the square, she draws the quadrilateral outside (Figure F.6) and repeats the conjecture C8 they want to prove: *so, this is if ABCD is a trapezium, the other one is a square* (129). Tiziana writes down hypothesis (AB//CD) and thesis (ABCD is a square). Then Alessandra transforms the thesis into: *so... we need to prove that, so, that all sides are congruent* (points at the sides of LMNP) (149). They do not know how to go on. At some point the teacher arrives (154) and tells them that they do not need to prove all the conjectures, but what matters is to formulate many conjectures and prove at least one: *try... if you already have conjectures try to prove the one you find the easiest... don't start from the most general case!* (173).

C8

P8

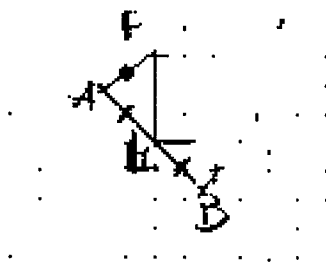

Figure F.6. A&T, Ep.4, #123

### F.2.5 Episode 5. Proving conjecture C4

(#176-#197, 0.31.20-0.39.10)

They start proving the conjecture C4. Tiziana: *let's do this one, which is easier* (points at the conjecture about the square) *the square... the square is easier, because the little triangles are congruent ...* (176). Tiziana draws a square on paper ABCD (178) and the inside quadrilateral LMNP (Figure F.7).

C4

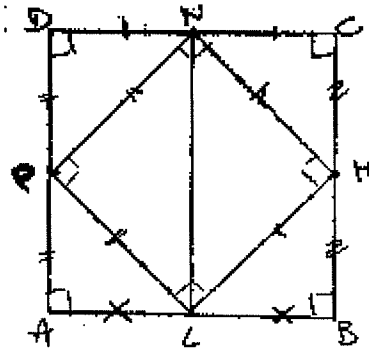

Figure F.7. A&amp;T, Ep.5, #178

Then she writes down hypothesis ( $AB=BC=CD=AD$  and  $AP=PD$ ,  $DN=NC$ ,  $CM=MB$ ,  $BL=LA$ ) and thesis ( $LM=MN=NP=LP$ ). And Alessandra states: *Alessandra: ok! Now we need to prove that ...it's true!* (182). Their proof P4 (183-197) shows that the triangles APL, LBM, NCM and PDN are equal two by two, therefore all sides PL, LM, NM and PN are equal, so LMNP is a rhombus. *Tiziana: so NC is congruent to... MC... PAL (angle) is congruent to NCM (angle) because ABCD square* (she writes down all this). *And so it has got right angles, right?* (189). *Tiziana: NCM triangle and MBL triangle  $\Rightarrow$  NM congruent to ML* (195). *Tiziana: so PL equals MN* (she writes it down). *The same for ...PDN triangle and LBM triangle  $\Rightarrow$  PN equals LM* (she writes it down) (193). *Tiziana: They all have equal angles. So it is a rhombus!* (she writes down  $\Rightarrow$  it is a RHOMBUS). *Ok! Is that all? and we must do it also... the parallelism* (197). Tiziana writes down the proof while she is constructing it (see Figure F.14).

P4

### F.2.6 Episode 6. Exploring again and verifying the proof P4: it's not a rhombus!

(#198-#247, 0.39.10-0.50.45)

After 20 seconds of silence, they decide to explore the figure in Cabri again. *Tiziana: let's explore the figure!* (200). After observing again that it is always a parallelogram (204), Tiziana suggests: *try to make ABCD a square* (207). *Alessandra drags ABCD into a square* (208 – Figure F.8) and then, referring to LMNP, Tiziana asks: *is it a rhombus?* (209). Observing that the figure on the screen does not have all sides equal, Alessandra exclaims: *rhombus has got equals sides...oh no! ...It's not a rhombus!* (211).

P4

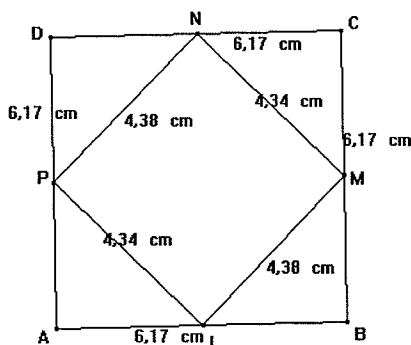

Figure F.8. A&amp;T, Ep.6, #208

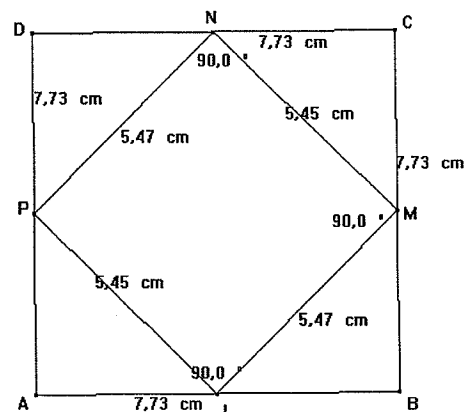

Figure F.9. A&amp;T, Ep.6, 231

Here a conflict between what they proved and what they see on the screen<sup>4</sup> starts and goes on for a while (212-282). Tiziana looks at LMNP on the screen and starts observing which

P4

<sup>4</sup> The conflict is between what they proved (i.e. that if ABCD is a square then the figure inside has got all equal sides) and what they see on the screen (i.e. a figure which does not have all equal sides, but only opposite sides equal and all angles

properties it has got: *yes, ... it has got opposite sides equal... and parallel... and the angles... they are equal, aren't they?... but I don't know how much they measure*(215). Tiziana measures the angles of LMNP (216) and sees that they are all  $90^\circ$ , so she concludes: *then... it's a square, I mean a rectangle, ok?...*(216). And immediately she goes on saying what they still need to prove: *so... then, it has got congruent sides, and we proved that. Now we need to prove that ... its angles are congruent?* (216) and then goes to paper and deletes part of the thesis they had written: *Tiziana: so, we need to go on. PM is... PM is not congruent to PN* (deletes the thesis she had written down on paper and writes *PN congruent to LM, NM congruent to PL*). *So PN... LM...* (deletes the part of the proof related to the congruence of PN and PL)... (222). Tiziana identifies the problem as: *the problem... is that this is not a square!...* (225) And goes on: *look... no... Because if you say that this equals this* (points at PD and DN on paper, Figure F.7) *and you say they have an equal angle* (points at angle D, and then at segments BL and BM) *and then this equals this* (PN and LM) *and this and this* (PL and MN) *...then this becomes a square* (LNMP), *but we've just seen that it is not a square* (pointing at the figure on the screen). *So it's all wrong!* (227). Tiziana does some dragging and then makes ABCD into a figure that for her looks like a square again<sup>5</sup> (Figure F.9, 231-233). She then changes the thesis they had before, making it become: *Thesis, the two opposite sides are congruent ....and the angles are right* (235). They realise that they have already proven that opposite sides are congruent, so Alessandra does not know what to do. But Tiziana is puzzled: *there's something I don't understand... I can't make sense of it!* (247)

### F.2.7 Episode 7. Trying to make sense of the proof P4 and the Cabri figure together

(#248-#282, 0.51.00-0.54.30)

The teacher arrives asking the girls how they are doing (248). Tiziana expresses the conflict between what Cabri shows and what they proved (251-264). Cabri shows that LMNP is a rectangle, i.e. opposite sides are equal: *if ABCD is a square... then the other should be a rectangle...because the measures (in Cabri) show that the opposite sides are congruent, so it is a rectangle* (251). But then she shows the teacher what they proved, i.e. that all sides of LMNP are equal if ABCD is a square: *because...if this is the midpoint* (she points at P) *then it divides this side in two equal parts* (she points at AD and AP and PD) (259). *This side* (PN) *should be congruent to this one* (LM). *But if all these parts are equal* (points at all the halves in which the sides of ABCD are divided by the midpoints), *all these angles are right angles* (points at the angles of ABCD), *then also these two sides are congruent* (points at PL and NM) (261). *So it should be, if it is a square, the quadrilateral inside is a square too* (263). So, as Tiziana puts it, the problem is: *why the figure doesn't show that?* (265). The teacher makes the girls reflect on how the Cabri figure was constructed, i.e. it is not a constructed square, but only a general quadrilateral that may look like a square: *I'll try to pose the problem from a different perspective: this figure* (points at the figure on the screen), *is it a square? Really?* (274).

P4

### F.2.8 Episode 8. Constructing a square in Cabri

(283#-#320, 0.54.30-1.01.00)

The girls understand what the problem with the figure is and attempt to construct a square according to its properties. First Tiziana constructs 4 lines parallel and perpendicular to one another (289), then marks the segments and hide the lines. She takes measurements of the sides (298- Figure F.10) to see if it is a square, and it is not. She wants to move one of the vertices to get a square (299), but for the kind of construction she did<sup>6</sup>, this is not possible.

---

are  $90^\circ$ . So it is a rectangle). The problem is that when they drag ABCD into a square, they pay attention only to the sides, so that the figure they have on the screen now is not a square, because the angles are not  $90^\circ$ . But they do not notice this.

<sup>5</sup> But the angles are actually not  $90^\circ$ .

<sup>6</sup> All the vertices of the figure are intersection points, so they cannot be moved.

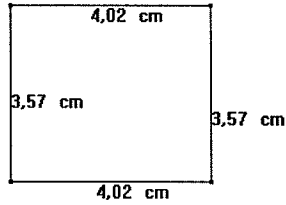

Figure F.10. A&amp;T, Ep.8, #298

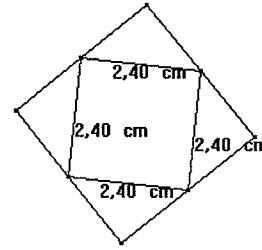

Figure F.11. A&amp;T, Ep.8, #313

The observer intervenes, asking them to construct something that stays a square in Cabri, whatever I move (305). Then she makes them reflect on the properties of a square and on how they construct squares in their drawing classes: *so how can I construct something with parallel and equal sides? I need to add something more, otherwise I get a rectangle. How do you normally construct a square with a compass in your drawing classes?* (309). Alessandra says that they do it with circles (309) and starts doing a circle in Cabri, but then Tiziana takes the mouse and constructs a quadrilateral with the option 'regular polygons' (313) and then the quadrilateral of the midpoints (Figure F.11). Tiziana observes that it (LMNP) is a square (318).

### F.2.9 Episode 9. Going back to conjecture C4 and proof P4

(#321-#332, 1.01.00-1.05.00)

The teacher suggests them going back to their conjecture and proof on paper (321). Tiziana recognises that it is their previous proof (326). They both go over it once again, proving that all sides of LMNP are equal (using the congruence criteria). Then they need to prove that the angles of LMNP are all equal, which Tiziana does, based on the congruence criteria (329-330).

P4

### F.2.10 Episode 10. The case of the isosceles trapezium (C8)

(#333-#402, 1.05.00-1.20.00)

The observer reminds the girls the case of the trapezium, which they had not finished yet (333). The teacher comes and suggests considering other configurations (341). Alessandra drags ABCD into Figure F.12 (342). Then Tiziana suggests considering a particular trapezium: *Tiziana: if it is an isosceles trapezium it's easier, because I know that this is congruent to this one (points at AD and BC). These two are equal (points at DN and NC)* (352). And finally Alessandra wants to write down the conjecture C8: *what's that?... I can't do it. So if ABCD is an isosceles trapezium... (358) Tiziana: ... then LMNP is a parallelogram (359)*. Then Tiziana clearly states: *we're not gonna prove it (361)*.

C8

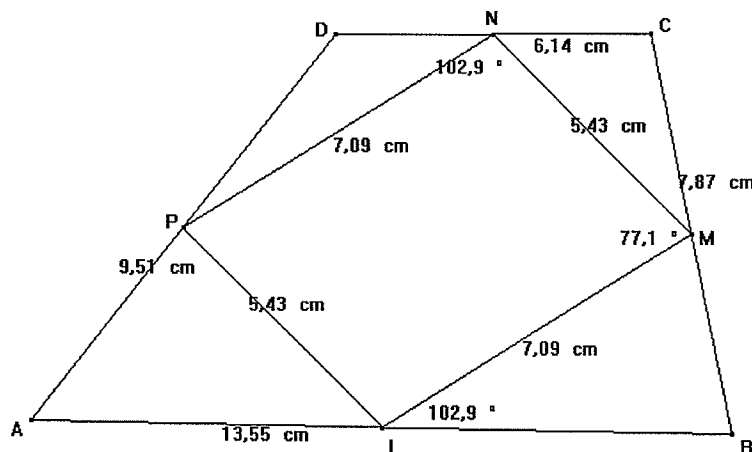

Figure F.12. A&amp;T, Ep.10, #342

After that they do some random dragging and random observations. First Tiziana makes ABCD a triangle (371), but then they abandon this configuration. They use the mouse alternatively and keep dragging ABCD randomly (379- 398). While Alessandra drags ABCD randomly, at some



point Tiziana formulates C1: right, it's the general one: whatever quadrilateral ABCD is ... the internal quadrilateral is always a parallelogram (398). Then she writes it down: if ABCD is a quadrilateral, then LMNP is a parallelogram (402).

C1

Figure F.13 and Figure F.14 are the students' paper work.

I lati opposti sono congruenti e paralleli  
 $\triangle LMP$

Rombi  
 Quadrato  
 Rettangolo

Se ABCD è un rettangolo allora LMNP è un rombo

9 Se ABCD è un quadrato allora LMNP è un quadrato

Se ABCD è un trapezio allora LMNP è un quadrilatero con i lati opposti paralleli e congruenti



$HE = AB \cap DC$   $AF = PD$   $DN = NC$   $CI = AB$   $BC = LA$   
 $T_3 = \triangle LMP$  è un quadrato

Figure F.13. A&T. Written work (1)

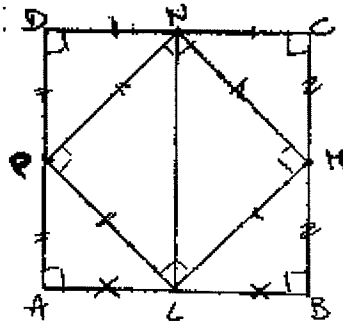

$tl_p = AB \cong BC \cong CD \cong DA$   
 $DN \cong NC \cong CL \cong LB \cong BP \cong PH$   
 $\cong PD \cong DC \cong CA \cong BA \cong AD$   
 $TS = \dots$   
 $PN \cong LN \cong NH \cong PL$   
 $N\hat{P}L \cong P\hat{L}H \cong L\hat{H}N \cong H\hat{N}P$

• Se ABCD è un quadrato allora LNHP è un quadrato

Dim.

Considero  $\triangle PCN$  e  $\triangle NLA$

$NC \cong LA$  per  $tl_p$

$CL \cong AN$  per  $tl_p$

$\hat{P}CN \cong \hat{N}LA$  ABCD quadrato per  $tl_p$

$\Rightarrow PC \cong LN$

Stesso ragionamento per  $\triangle PND$  e  $\triangle NHB$   $\Rightarrow PN \cong NH$   
 $\triangle PND$  e  $\triangle NLA$   $\Rightarrow PN \cong PL$

$\triangle NCH$  e  $\triangle NLA$   $\Rightarrow NH \cong NL$

$\Rightarrow$  è un ~~quadrato~~ QUADRATO!

Considero  $\triangle NPL$  e  $\triangle NPH$

$NP \cong NH$  per dim.

$PL \cong HN$  "

$NL$  in comune

$\Rightarrow \triangle NPL \cong \triangle NPH$  stessa cosa per  $\triangle PNH \cong \triangle HLP$

• Se ABCD è un trapezio isoscele allora LNHP è un parallelogramma.

~~Se ABCD è un quadrato allora LNHP è un quadrato.~~  
 • Se ABCD è un quadrato allora LNHP è un parallelogramma.

Figure F.14. A&T. Written work (2)

### F.3 SUMMARY OF CONJECTURES AND PROOFS

Table F.1 summarises the conjectures and proofs made by Alessanadra and Tiziana. The numbers refer to the lines in the transcript where the conjecture or proof was being constructed.

Conjectures	# <sup>7</sup>	#	Proofs
<b>C1</b> <sup>8</sup> LMNP is a parallelogram	16, 19, 22, 23, 28-29, 204, 398, 402	No proof	<b>P1</b>
<b>C2</b> LMNP is a rhombus	38	No proof	<b>P2</b>
<b>C3</b> LMNP is a rectangle	40	No proof	<b>P3</b>
<b>C4</b> If ABCD square then LMNP ...	41, 53-54, 69, 80-81, 207, 318	179-182, 189, 193-197, 326-330	<b>P4</b>
<b>C5</b> If ABCD rectangle then LMNP rhombus	63-68, 170	No proof	<b>P5</b>
<b>C6</b> If ABCD rhombus then LMNP rhombus	82	No proof	<b>P6</b>
<b>C7</b> If ABCD parallelogram, then LMNP rhombus (incorrect)	87	No proof	<b>P7</b>
<b>C8</b> If ABCD isosceles trapezium then LMNP parallelogram	114, 129, 161, 343, 358-360, 385	149, 347-348, 361	<b>P8</b>

Table F.1. A&T. Conjectures and proofs

Table F.2 below shows the proving process and how conjectures and proofs developed and interweave over time.

<sup>7</sup> The numbers refer to the lines in the transcript. For each conjecture and proof, I identified the lines in which the students either make a statement which is related to the final conjecture or work towards proving that conjecture.

<sup>8</sup> The formulation of the conjectures is not necessarily the one made by the students.

Ep	C1	C2	C3	C4	C5	C6	C7	C8	#
	○								16
	○								19
	○								22-23
	○								28-29
		○							38
			○						40
				○					41
				○					53-54
					○				63-68
				○					69
				○					80-81
						○			82
							○		87
								○	114
								○	129
								●	149
								○	161
					○				170
				●					179-182
				●					189
				●					193-197
	○								204
				○					207
				○					318
				●					326-330
								○	343
								●	347-348
								○	358-360
								●	361
								○	385
	○								398
	○								402

Table F.2. A&amp;T. Evolution of conjectures and proofs.

---

○<sup>9</sup> = conjecture, ● = proof

---

<sup>9</sup>The symbols ○ and ● indicate either the moment in which the conjecture or proof was made or the moments in which students worked towards that conjecture or proof.

---

## APPENDIX G. THE STORY OF VALENTINA, MICHELA AND ELISA (CASE 4)

### G.1 THE CONTEXT

Valentina, Michela and Elisa are 17-year-old students from a fourth year classroom of a Liceo Scientifico in Finale Ligure (Italy)<sup>1</sup>. They are medium-high achievers. They had used Cabri for one year before this intervention. The problem given to the students was: Perpendicular Bisectors of a quadrilateral (see Figure E.1, p.312). The session took place on the 9<sup>th</sup> February 2000.

The students were presented with the problem and asked to formulate conjectures and try to prove them. They were given a worksheet with the statement of the problem but were not explicitly asked to write conjectures and proofs down. The session lasted 1 hour and 30 minutes. The teacher was left free to intervene and he intervened twice. The first time he was asked questions about perpendicular bisectors in a triangle and he answered quite directly all questions; the second time he intervened together with the observer to discuss a problem of representation of figures in Cabri<sup>2</sup>.

### G.2 THE PROVING PROCESS OF VALENTINA, MICHELA AND ELISA

This section presents the story of the solution process the students undertook, divided into episodes. The construction of conjectures and proofs will be described as they were discovered, formulated and written down. The conjectures are numbered in order of appearance as C1, C2 etc. and so are the proofs (P1 is the proof for C1, P2 for C2 and so on). All the statements which are a different formulation for conjecture Cn are named Cn. The numbers #n refer to lines in the transcript<sup>3</sup>. The description of the events is in normal Times. *The students' talk is in italics*. The written statements are in this font.

#### G.2.1 Episode 1. Constructing the figure

(#1-#37, 0.00.00-0.04.05)

Elisa has the mouse and Michela the keyboard. Elisa constructs a quadrilateral first and then the

---

<sup>1</sup> For a detailed description of the context of the Italian setting see chapter 4 (p.74).

<sup>2</sup> When the students make the quadrilateral degenerate into a triangle Cabri still keeps the four bisectors, so that they do not intersect all in the same point, which contrasts what students have learnt about perpendicular bisectors in a triangle.

<sup>3</sup> The numbers should help the reader to have a sense of at what time in the process things happened or were said.

perpendicular bisectors of its sides. As soon as she finishes she says: *girls, I can't see a thing! ... labels ... (12)*. So Elisa starts putting labels to the vertices of ABCD and then to the perpendicular bisectors and finally to the intersections points, while Valentina tells her what letters she needs to use. The final figure is Figure G.1.

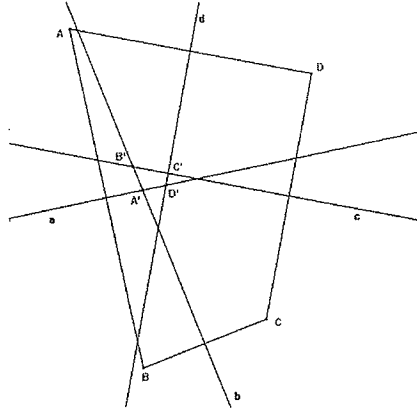

Figure G.1. V&M&E, Ep.1, #37

## G.2.2 Episode 2. Starting to explore the case of the square (C1) and the case of the parallelogram (C2)

(#38-#112, 0.04.05-0.14.00)

After the construction, Michela sets what to do next: *now we must see how it changes when the external quadrilateral changes... (39)*. They decide to put colours for the quadrilateral A'B'C'D' and Elisa does it (55). Then Elisa sets out her strategy: *let's try ... let's try to see the regular quadrilaterals outside ... (57)*.

### a. Starting with the case of the square (C1)

Michela suggests that, *maybe we could start with the square, ... (58)*. Valentina asks what the properties of the perpendicular bisectors are (60) and Michela and Elisa say that it goes through the midpoint and it is perpendicular (62-63). Then Elisa drags the quadrilateral into a square, then into a sort of trapezium, to conclude (C1) that if it is a square: *no, I mean ... it degenerates into a point... it's logic, isn't it? ... (69)*. Then she explains it again and prove it orally (C1-P1): *I'm saying that if the opposite sides are parallel, those ones are perpendicular. Is that ok?... and if they are equal the midpoint is on the same line (71)*. After that she drags ABCD into a rectangle (72), then drags it randomly (74), until Valentina asks her what she is doing (77). While Elisa is already focusing on something new, Valentina wants to make clear the situation about the square (79). Michela explains to Valentina how Elisa proved that if there is a square outside then it degenerates into a point inside: *so, she said, since the properties of the perpendicular bisector are perpendicularity and the distance from a point ... if ... all the segments are parallel, then, since they are perpendicular ... Moreover if 2 of ... as for example in a square, the midpoint must be on the same line. (80)*.

C1

P1

P1

### b. The case of the parallelogram (C2)

Elisa drags ABCD into a parallelogram (Figure G.2 - 82), then she formulates a conjecture about the case of the parallelogram (C2), intertwined with the proof P2 (83-85): *Elisa: I'm doing a parallelogram ... the sides are parallel aren't they in a parallelogram? Therefore the perpendicular bisectors are parallel too, aren't they? They are parallel 2 by 2. (83). Elisa: so also the segments of A'B'C'D' are parallel ... (85)*. As a way to check this conjecture Elisa does the following: *let's try to move the point and see what changes slowly (Elisa drags C a little and slowly). So now they are no longer parallel, so ... these 2 (pointing at d and b) they are no longer parallel ... well, it's logic ... and these 2 (a e c) not... This is what we've been saying till now. (93)*.

C2

P2

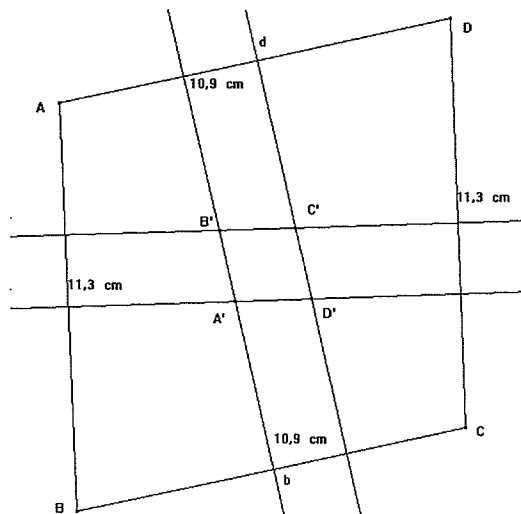

Figure G.2. V&M&E, Ep.2, #82

**c. What figure inside? (C3)**

Elisa now looks at the figure inside and wants to get a square inside. She provides a justification for which it can never be a square inside.; *is there a way to do ... the ... that they are parallel ... a square ... for example that inside it is a square; the sides should be parallel 2 by 2 and ... but one longer than the other one! Isn't it? ... but then it can never be, because if ... then these 2 (points at the sides of ABCD) are no longer parallel. (95). Then Michela states C3: so it can never be a square inside! (96) ... not even a rectangle! (98). Elisa: it can only be ... a trapezium (99). Michela: ... or a parallelogram (100). Valentina wants to understand why (102). Elisa explains again what she said before (111-112) and Valentina is happy with it.*

C3

**G.2.3 Episode 3. A'B'C'D' degenerating into a point: conjecturing (C4), checking and proving**

(#113-#191, 0.14.00-0.22.30)

Michela drags B and stops when the perpendicular bisectors meet at a point (113) - Figure G.3.

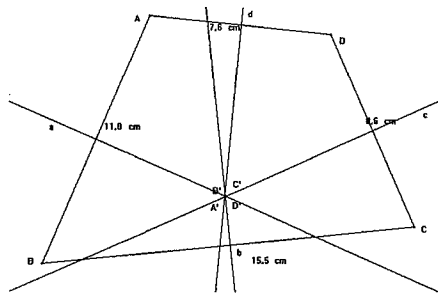

Figure G.3. V&M&E, Ep.3, #113

Elisa sees that: *oh dear! It's a point again! ... (115). So she asks the mouse back (116) and wants to see what happens to ABCD when keeping the point inside: I'll try to move that stuff .. and the point ... keeping the point inside ... I mean moving the point, but keeping that ... the quadrilateral is a point. (120). Elisa drags a bit, then put measurements to the angles. They think of triangles and at the end Elisa comes up with: however I'm trying to say: maybe it is related to ... the circumcentre is the centre of the ... of the inscribed circle? (136). They discuss about triangles and circumcentres until Michela says maybe when it is a quadrilateral it can be inscribed in a circle... (143). Suddenly after this, Elisa seems to have the solution and she talks very fast through the conjecture C4 and proof P4, as follows. Elisa: no, no, I got it! It is the circumcentre ... it is the one from the inscribed circle, because it must be equidistant from the sides, mustn't it? (points at the video with fingers). This point (the intersection of the perpendicular bisectors) is the perpendicular bisector of this segment (AD) so it is equidistant from here and there (from A and from D). (150). Elisa: so this point here (points at the assumed circumcentre) ...if you have...look, a, which is the perpendicular bisector, is equidistant from the endpoints... (152). Elisa: ...because the perpendicular bisector is the locus of a point equidistant from*

C4

P4

the endpoints... so it is equidistant from this one and from this one (Elisa points at the distances from the circumcentre to A and B). But from here (A), these two are equal... (She says this again, touching with her fingers one vertex, the centre and the other vertex, doing it for all sides) ...therefore at the end they are all equal and it is the radius, isn't it?... (154). Then Michela suggests to construct the circle (158), but Elisa says it is enough to measure opposite angles, because in cyclic quadrilaterals the sum of opposite angles is  $180^\circ$  (161). Elisa puts measurements and then drags ABCD so that it keeps the point inside, in order to check if the sum of opposite angles stays 180 (173-176). Then she goes over the proof P4 again: Anyway, the proof is that ... the perpendicular bisectors are equidistant from the vertices ... so this point (points at the intersection of the perpendicular bisectors) is equidistant from these 2 vertices (A and B), but also from these (A and D), and also from these (D and C) and also from these (C and B) ...isn't it?... so finally.... (176).

**G.2.4 Episode 4. Concave and convex quadrilaterals (C5)**

(#192-#226, 0.22.30-0.27.25)

Elisa drags B fast and randomly (192). After Valentina asks her what she is doing, Elisa says: I was looking at the concave and convex quadrilaterals! (196). After exploring (Figure G.4) and trying to remember what concave and convex quadrilaterals are, Elisa formulates conjecture C5: Until it is concave, the blue one is concave too. Then now it is a flat angle ... it changes, you see? ... and it becomes ... the other one becomes convex too (203).

C5

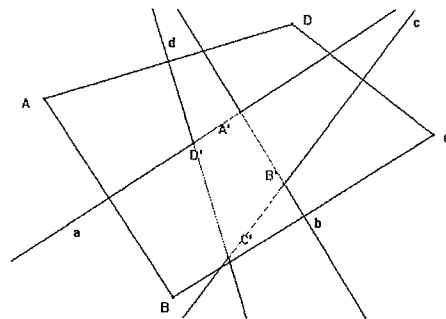

Figure G.4. V&M&E, Ep.4, #200

**G.2.5 Episode 5. The case of the rhombus (C6) and the isosceles trapezium (C7)**

(#227-#272, 0.27.25-0.34.00)

Elisa drags C randomly (227) and Michela suggests considering a rhombus (228). Elisa asks if she wants the outside or inside quadrilateral to be a rhombus (229). Michela is focusing on the inside quadrilateral, while Valentina is looking at the outside one (232).

**a. the case of the isosceles trapezium (C7)**

The idea of Michela is abandoned, as Valentina suggests considering an isosceles trapezium outside (235). Elisa immediately says C7 with a bit of justification, linked to their previous conjectures: it's a point, isn't it? The isosceles trapezium can be inscribed in a circle ... (238 -P7).

C7  
P7

**b. the case of the rhombus (C6)**

Elisa recalls the conjecture about the parallelogram (C2) and the justification: yes, because when opposite sides are parallel, the perpendicular bisectors are parallel too ... so for a parallelogram they must have opposite sides ... and... (247) ... parallel 2 by 2. (249). Michela follows with: therefore the rhombus too (250). Then Valentina says that for sure if it is a rhombus outside it will be a parallelogram inside, but she does not know if it will be a rhombus (253). And Michela agrees (256). Meanwhile Elisa drags the quadrilateral into a rhombus (Figure G.5).

C2



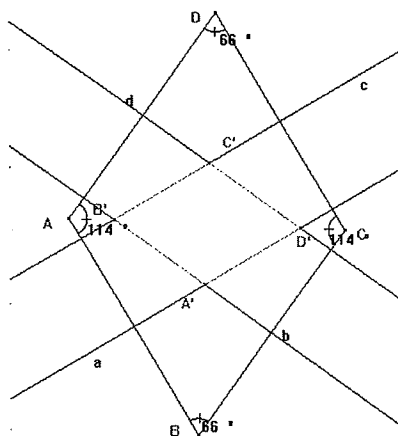

Figure G.5. V&M&E, Ep.5, #257

They all try to read from the figure if the quadrilateral inside is a rhombus or not, by looking at the measurements of the sides (263-265). After seeing on the figure that the sides are equal, Valentina provide an explanation for the fact that  $C'B'=A'D'$  and  $A'B'=C'D'$ : *yes, we know they are equal 2 by 2, the reason why they must be equal 2 by 2 .... (267). because they are parallel ... I mean, this one is parallel to this one (B'C' to A'D') this one is parallel to this one (A'B' to D'C') ... it must be, am I right?... If they were not parallel (points at the screen with her hand a line not parallel to the perpendicular bisectors) ... then they would be different? ...right? ... (269).*

P6

### G.2.6 Episode 6. Proving C6

(#273-#386, 0.34.00-0.51.00)

Valentina states what they have to prove still, in order to prove that  $A'B'C'D'$  is a rhombus (when outside it is a rhombus), i.e. that  $C'B'=C'D'$ <sup>4</sup>. Since they already know it is a parallelogram, they only need to show that two adjacent sides are equal. *Valentina: they must... they are equal 2 by 2. The problem is that now we should prove that this one equals this one... (points at A'D' and D'C' and then at A'B' and B'C'). They break this down into different steps.*

P6

First, they consider triangles L and M (Figure G.6) and prove they are congruent, after having seen it from the figure. *Elisa: yes we do, because we prove it like that: this one (half of AD) and this one (half of CD) are equal, because they are half two equal sides, this one is right angle, and then they have the angle ... this one (DAC) which is equal because they are angles of an isosceles triangle. So they are congruent! (314).* Then they want to show that segments  $dC'$  and  $cC'$  are equal. *Michela: Now we must check that here... (319) Elisa: ... that these 2 are equal (points at the 2 segments belonging to c and d with one endpoint on the sides of ABCD and the other one in C') (320).* Valentina suggests: *if you prove that this one equals that one (she points at the two coloured quadrilaterals in Figure G.7), you automatically prove that this one (C'D') equals this one (B'C') (326).* But Elisa suggests another way: *excuse me, the only way to prove that these 2 are equal (she means the segments belonging to c and d with one endpoint on the sides of ABCD and the other one in C'), is by proving that these 2 triangles (obtained by linking D with C') are equal, isn't it?... They want to prove that those two triangles are congruent by considering the angle C as one of the congruent elements, assuming that  $DC'$  is the bisector of angle C, which they do not know. They discuss about this (333-349).*

Michela suggests considering triangles L and N (Figure G.8) and she proves they are equal (361-367).

<sup>4</sup> A proof would be as follows. Triangles L and M are equal because:  $Ad^4=cC$ , one right angle and  $\angle DAC=\angle DCA$ . So  $dD'=cB'$ . Then  $C'd=C'c$  because triangles  $DdC'=DcC'$ , because  $Dd=Dc$ , one right angle and they share  $DC'$ . So  $C'D'=B'C'$  by difference of equal segments. (c indicates the midpoint of CD and d indicates the midpoint of AD).

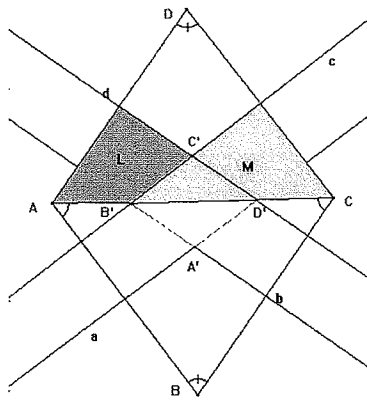

Figure G.6.

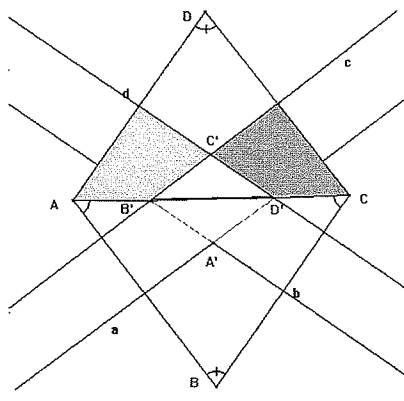

Figure G.7

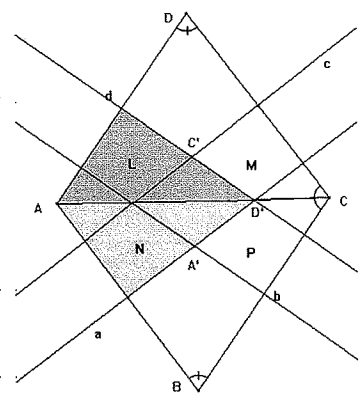

Figure G.8

Then Elisa seems to have an idea: *this means... no, so ...surely it is linked to the sides, because when this side (points with the mouse at the segment from A to the midpoint of AD) is no longer equal to this one (from C to the midpoint of DC), this one (D'C') is no longer equal to this one (B'C') and till this point it's fine, isn't it?* (379). But at the end the girls abandon this proof as Elisa suggests looking at something else (386).

### G.2.7 Episode 7. Summary and new exploration - the case of the triangle outside (C8) and inside (C9)

(#387-#531, 0.51.00-1.13.40)

The girls recall the conjectures (394-401) they made before (C4, C5, C2 and C6). Michela reminds the girls that they still need to prove the case of the rhombus: *we know the one about the parallelogram, we need to prove that it is a rhombus ...* (402). Elisa recalls what they know about the rhombus: *we know that it has got parallel sides, but we don't know that it has got equal sides.* (403). Then Elisa drags ABCD into a triangle (403 - Figure G.9) and says **C8**: *...when it degenerates into a triangle, it's not a figure, because ...* (403) ... *Elisa: ...the perpendicular bisectors are parallel so we can't talk about ... a quadrilateral ...* (405). And then focuses on the inside (**C9**): *and inside ... is there a way in which it is a triangle inside?* (405)

C4  
C5  
C2  
C6  
C8  
C9

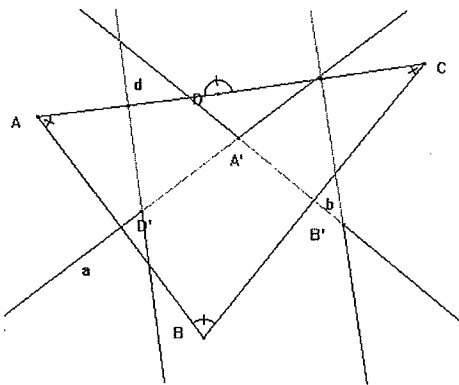

Figure G.9. V&M&E, Ep.7, #403

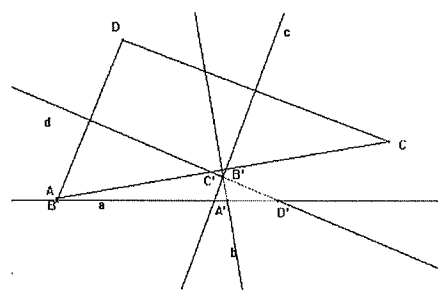

Figure G.10. V&M&E, Ep.7, #448

Elisa drags B to keep a triangle inside (421) and Valentina states that that one (keeping a figure inside and looking at what the figure outside becomes) was the strategy she suggested before (419). They see that the situation is different, according to how they get a triangle outside: if they put D on the same line as A and C, then there is a point inside (C8), while if they make two vertices coincide, then there is a triangle inside (C9). Then they see that when two vertices coincide and ABCD becomes a triangle, still the bisector of the side which disappeared, remains visible (448 - Figure G.10). They cannot explain this fact, and they start a long discussion about triangles and perpendicular bisectors of sides (450-469), which involves the teacher too, and ends up with making sure that in a triangle the perpendicular bisectors always meet at a point and it is the circumcentre. So again Elisa and Valentina stress the fact that: *Elisa: no, I'm saying that then this line (a) ...* (472), *Valentina: ... shouldn't exist?* (473).

In 498 they call the teacher again in order to make sense of the fact that that perpendicular bisector remains visible even if it should not exist. The discussion involves the observer as well (which takes the

role of expert) and goes on for a long time (498-531) and concludes with *Observer: no, in fact it does not exist (530)* which leads Elisa to formulate the conjecture C8: *Elisa: so when it is a triangle ... it must be a point (431).*

C8

### G.2.8 Episode 8. Summarising. The case of the right-angled trapezium (C10) and the case of the general trapezium (C11)

(#532-#560, 1.13.40-1.17.30)

The new episode starts with Elisa dragging randomly D (532). She then asks what figure they can still do: *what figure can we make outside? (533)* Then she starts summarising what they did till now: *We did a triangle (C9), a square (C1)... (533). ...rectangle, square ... those ones can be inscribed in a circle, so it degenerates into a point (C4) (535).* Michela adds: *Michela: exactly ... the only one is the parallelogram, which we saw is a parallelogram (C2), for the rhombus we must show that (C6)... (536).* Valentina mentions the trapezium (537) and the fact they did only the isosceles trapezium (539). Elisa drags the figure into a trapezium (541 - Figure G.11).

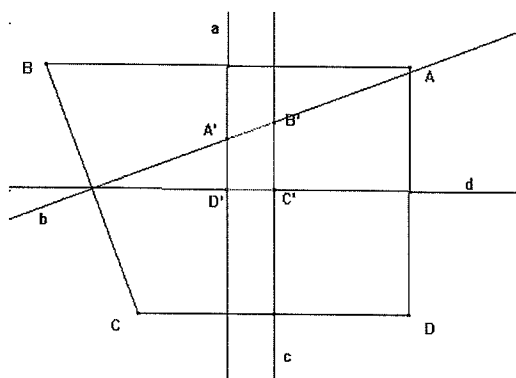

Figure G.11. V&M&E, Ep.8, #541

#### a. The case of the right angled trapezium (C10): conjecturing and proving

Elisa makes the trapezium become a right-angled trapezium (545) and Michela immediately says C10: *inside it becomes another right angled trapezium (546).* Elisa starts thinking why (547) and then confirms the conjecture (551) and seems to have understood why is that so. Then Elisa makes an oral proof P10<sup>5</sup> (549-555), which is the following. *Elisa: this one is the perpendicular bisector of this one (points at the screen) and this one ... so this one is perpendicular to this one (d to c), because the sides are perpendicular. This one is perpendicular to this one (a to d) so this one is perpendicular to that one (a to d) and 2 right angles are formed ... (553).* Valentina: *a trapezium must have two parallel side (554).* Elisa: *... which it has got, because these 2 are parallel and so, again, these 2 are parallel. Then this one is right, because this one (AD) is perpendicular to the parallel sides and so its perpendicular line ... isn't it? I mean, 3 would be parallel (a, c and AD)... if this one (d) is perpendicular to that one (AD) it is perpendicular to the other ones too, isn't it? (555).* Elisa: *these 3 are parallel ... because they are all perpendicular to two parallel lines (the bases of the trapezium), right? Then this one (d) is a line perpendicular to this one, it must be perpendicular to the other 2 as well, because they are parallel. (557).* The two other girls agree (556).

C10

P10

#### b. The case of the trapezium (C11 - If ABCD is any trapezium, then LMNP is a trapezium)

Valentina asks: *if we do any random trapezium, what will come out? (558 -C11).* Elisa drags D to get another trapezium (559 - Figure G.12) and then seems to see that it is the same proof as before: *Elisa: like that? ... These 2 are parallel (AB and CD), so these two are parallel too (a and c) and the other ones are ... it's always the same discourse that if two sides are parallel, their perpendicular bisectors are parallel too... (560)*

C11

P11

<sup>5</sup> The proof is based on the fact that a trapezium has two parallel sides, and therefore two parallel perpendicular bisectors, and then a right-angled trapezium has two perpendicular sides and therefore two perpendicular bisectors are perpendicular. This means that the figure inside is still a right-angled trapezium.

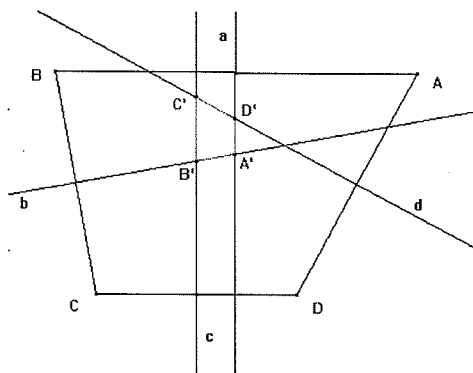

Figure G.12. V&amp;M&amp;E, Ep.8, #559

### G.2.9 Episode 9. Proving the case of the rhombus (C6)

(#561-#619, 1.17.30-1.27.00)

Michela suggests going back to the case of the rhombus (C6) (561). Valentina takes the mouse and tries to make a rhombus (562-564 - Figure G.13).

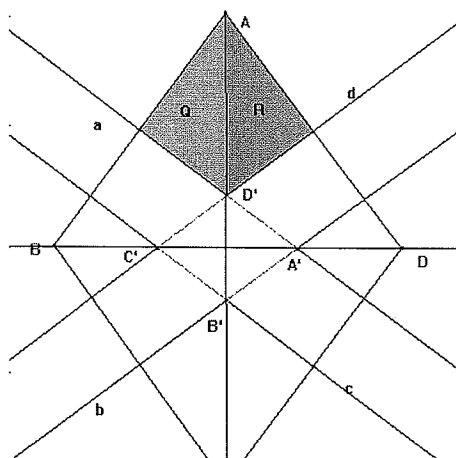

Figure G.13. V&amp;M&amp;E, Ep.9, #564

The problem of the proof, starting from where they left it) is to understand if they can say (they know) that  $B'$  belongs to  $AC$  (i.e. to the angle bisector of angle  $A$ ) or not. Michela suggests to consider the isosceles triangle  $ABD$  (567) and then states the problem again: *the problem is ... you know, before you were saying: the problem we had before was that we didn't know if this one ( $AC$ ) was a bisector, what did we say then?* (570). Michela recalls a property of isosceles triangles (573), while Elisa seems to have the situation clear (574). She does some reasoning which assumes that  $D'$  belongs to the  $AC$ , which they haven't explained yet: *this point here ( $D'$ ) is equidistant from the side because it belongs to the angle bisector, isn't it?* (584). Michela reminds Elisa that: *the problem is that we don't know that the angle bisector goes exactly through that point (points at  $AC$  and  $D'$ )* (585). Michela tries again to put forwards her thinking: *but I was thinking ...* (587) and this time Elisa takes it on board (588). The reasoning they pursue in 589-598) is the following. In a triangle all perpendicular bisectors meet at a point.  $D'$  is the intersection of  $a$  and  $d$ , so it belongs also to the perpendicular bisector of  $BD$ . Since  $ABD$  is an isosceles triangle, the perpendicular bisector of  $BD$  is also an altitude and also a bisector. So  $D'$  belongs to the angle bisector of  $A$ , i.e. to  $AC$ , which is what they wanted. *Elisa: so the angle bisector goes through that point.* (598). So Elisa can prove that triangles  $Q$  and  $R$  are congruent (598). But she has forgotten why they wanted to prove that (598). Valentina intervenes and all together they can finish the proof (599-601). *Valentina: because that way we prove that these 2 sides are equal...* (the segments from  $B'$  to the midpoints of  $AD$  and  $AB$ ) (599). *Elisa: ah, right, these 2 are equal ... and so ... if these 2 big ones are equal (the segments from  $A'$  to the midpoint of  $AB$  and from  $C'$  to the midpoint of  $AD$ )...* (600). *Michela: and these 2 small ones are equal (the segments from  $B'$  to the midpoints of  $AB$  and  $AD$ ), then also these 2 are equal by difference ( $A'B'$  and  $B'C'$ ) ... we made it!* (601).

P6

### G.3 SUMMARY OF CONJECTURES AND PROOFS

Table G.1 summarises the conjectures and proofs made by Valentina, Michela and Elisa. The numbers refer to the lines in the transcript where the conjecture or proof was being constructed.

Conjectures	# <sup>6</sup>	#	Proofs
<b>C1</b> <sup>7</sup> If ABCD square, then A'B'C'D' point	58, 69	71, 80, 88, 89-93	<b>P1</b>
<b>C2</b> If ABCD parallelogram then A'B'C'D' parallelogram	245, 401, 536	83, 85, 247	<b>P2</b>
<b>C3</b> A'B'C'D' can be ...	95-101	102, 110-112	<b>P3</b>
<b>C4</b> If ABCD cyclic, then A'B'C'D' point	115, 145, 186, 243, 394- 396, 535	150-152, 154, 176	<b>P4</b>
<b>C5</b> If ABCD is concave ...If ABCD is convex ...	194, 198, 203, 223, 401		<b>P5</b>
<b>C6</b> If ABCD rhombus, then A'B'C'D' rhombus	228-230, 251, 253, 256, 262, 401	266-269, 273, 298-319, 402-403, 536, 598-601	<b>P6</b>
<b>C7</b> If ABCD isosceles trapezium then A'B'C'D' is a point	235-238	238-239, 243	<b>P7</b>
<b>C8</b> If ABCD triangle ...	403, 431, 437	404-405	<b>P8</b>
<b>C9</b> ... then A'B'C'D' triangle	405, 423, 437, 440, 486	426	<b>P9</b>
<b>C10</b> If ABCD is a right angled trapezium, then LMNP is a right- angled trapezium	454-546	547, 551-557	<b>P10</b>
<b>C11</b> If ABCD is any trapezium, then LMNP is a trapezium	558	560	<b>P11</b>

Table G.1. V&M&E. Conjectures and proofs

Table G.2 below shows the proving process and how conjectures and proofs developed and interweave over time.

---

○<sup>8</sup> = conjecture, ● = proof

---

<sup>6</sup> The numbers refer to the lines in the transcript. For each conjecture and proof, I identified the lines in which the students either make a statement which is related to the final conjecture or work towards proving that conjecture.

<sup>7</sup> The formulation of the conjectures is not necessarily the one made by the students.

<sup>8</sup> The symbols ○ and ● indicate either the moment in which the conjecture or proof was made or the moments in which students worked towards that conjecture or proof.

Ep	C1	C2	C3	C4	C5	C6	C7	C8	C9	C10	C11	#
	○											58
	○											69
	●											71
	●											80
		●										83-85
	●											88-93
			○									95-101
			●									102
			●									110-112
				○								115
				○								145
				●								150-154
				●								176
				○								186
					○							194
					○							198
					○							203
					○							223
						○						228-230
							○					235-238
							●					239
				○			●					243
		○										245
		●										247
						○						251
						○						253
						○						256
						○						262
						●						266-269
						●						273
						●						298-319
				○								394-396
		○			○	○						401
						●		○				402-403
								●	○			404-405
									○			423
									●			426
								○				431
								○	○			437-440
									○			486
				○								535
		○				●						536
										○		545-546
										●		547
										●		551-557
											○	558
											●	560
						●						598-601

Table G.2. V&M&E. Evolution of conjectures and proofs.

---

## APPENDIX H. THE STORY OF ALICE AND WILL (CASE 5)

### H.1 THE CONTEXT

Alice and Will are A-level students from a Further Mathematics A-level course in Churchill School in Bristol<sup>1</sup>. They used Cabri in two sessions before this one, in which they worked with constructions and macro-constructions and they were shown the use of the dragging test. The problem given to the students was: Angle Bisectors of a quadrilateral (Figure H.1). The session took place on the 27<sup>th</sup> September 1999.

Let  $ABCD$  be a quadrilateral. Consider the bisectors of its internal angles and the intersection points  $H, K, L, M$  of pairs of consecutive bisectors.

1. Drag  $ABCD$ , considering different configurations. What happens to the quadrilateral  $HKLM$ ? What kind of figure does it become?
2. Can  $HKLM$  become any quadrilateral? Why?
3. Can  $HKLM$  become a point? Which hypothesis on  $ABCD$  do you need in order to have this situation?

Write down your conjectures and prove them.

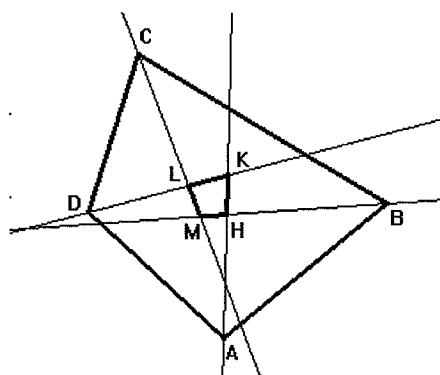

Figure H.1. A&W. Angle bisectors of a quadrilateral

In this session they were asked to work on the problem presented above and then to present their conjectures and proofs to the whole class using an OHP. The session lasted 1 hour and 15 minutes (1 hour for the work in pairs at the computer and 15 minutes for the presentations). In this session we let the teacher free to intervene because it was only the second session of the project and the students were not very familiar yet with the type of problems and with Cabri. The teacher intervened twice: once to ask the students what they were up to and once to remind them that they had to write down their conjectures and

---

<sup>1</sup> For a detailed description of the context of the setting see chapter 4 (p.72).

proofs. The observer intervened once to show the students how to use the 'check property' tools.

## H.2 THE PROVING PROCESS OF ALICE AND WILL

This section presents the story of the solution process the students undertook, divided into episodes. The construction of conjectures and proofs will be described as they were discovered, formulated and written down. The conjectures are numbered in order of appearance as C1, C2 etc. and so are the proofs (P1 is the proof for C1, P2 for C2 and so on). All the statements which are a different formulation for conjecture Cn are named Cn. The numbers #n refer to lines in the transcript<sup>2</sup>. The description of the events is in normal Times. *The students' talk is in italics.* The written statements are in this font.

### H.2.1 Episode 1. Constructing the figure

(#1-#5, time: 0.00.00-0.01.12)

Alice constructs a quadrilateral and its angle bisectors (#1) very quickly. Then she draws segments on the bisectors and hides the bisectors (#5 - Figure H.2).

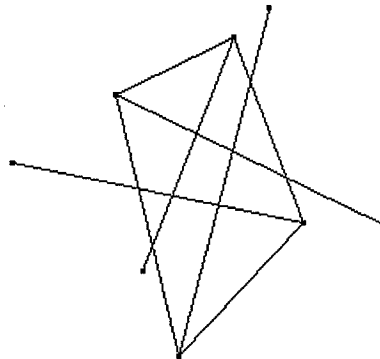

Figure H.2. A&W, Ep.1, #5

### H.2.2 Episode 2. Starting the exploration. The case of the point (C1) and the case of the parallelogram (C2)

(#6-#69, time: 0.01.13-0.09.59)

#### a. The case of the point (C1)

Alice starts moving the quadrilateral slowly and while moving she makes a series of oral observations which are finally turned into a conjecture by Will. She starts by saying that *it changes*

<sup>2</sup> The numbers should help the reader to have a sense of at what time in the process things happened or were said.



the shape (#7), then it turns into something else (#10); then she stops when HKLM<sup>3</sup> is a point and says it's a point now (#12); finally Will formulates the conjecture *if it is a square it will be a point* (#13- C1).

## b. Other explorations. Towards the conjecture about the parallelogram (C2)

Alice sees that there are positions for which the segments of the bisectors disappear, saying that *It can't when it's made outside* (#19).

Then they discuss the possibility for HKLM to be a square and for what ABCD this happens (#25-#40). This is intertwined with observations about the relationship between the parallelism of the sides of the two quadrilaterals (#36 - #45). All the spoken observations appear to be like a 'brainstorming'. The first observation is: *It may be a square* (#25). Alice then observes that *those two are parallel* (the bisectors) (#36). After dragging, she refuses the observation made in #25, saying: *I think it can't be a square* (#40). Will suggests to *draw a perfect square* (#42), but the suggestion is not followed by Alice. Alice states again her previous observation, but expressing a relationship *If those lines* (two sides) *are parallel then these are parallel* (two bisectors) (#45 - Figure H.3- C2).

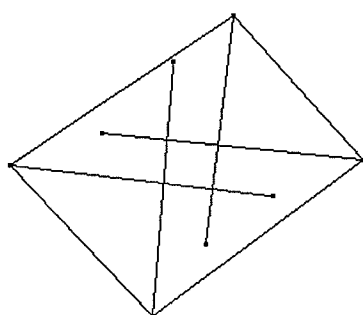

Figure H.3. A&W, Ep.2, #45

This observation is then checked with the 'check property'<sup>4</sup> tool in Cabri. This says that the lines are not parallel, because, since the lines have not been constructed as such, it is very difficult to make them parallel on the screen. In Figure H.3 they look parallel but they are actually not. Will then tries to drag in order to make the lines parallel, but he cannot<sup>5</sup>. The conclusion they make in #51 is the opposite of the one in #45, in fact Alice says that *maybe they* (the bisectors) *are never parallel*. After some more dragging, Alice finally states that *you can ... oh yes...so that's a square* (#66), when she gets a figure in which she can see a square inside. Then the conjecture C1 is reformulated again orally as *If it's a square they* (the bisectors) *will definitely cross at a point* (#69).

### H.2.3 Episode 3. Guided exploration. The case of the rectangle (C3)

(#70-#98, time: 0.10.00-0.12.40)

In #70 Will suggests considering other shapes. They start making ABCD a rectangle<sup>6</sup> (by deforming it and not by constructing a new rectangle) and Alice first observes that *Oh they* (the bisectors) *are parallel!* (#76) and then formulates the conjecture *If it is a rectangle it is a square* (#79- C3). After that, they try to find out what the inside quadrilateral cannot become<sup>7</sup> and Will

<sup>3</sup> Even if Alice and Will did not put names for the two quadrilaterals on their Cabri figure, I will refer to the quadrilaterals as ABCD and HKLM, referring to Figure H.1 to make it easier for a reader to understand what the students refer to when they talk.

<sup>4</sup> The 'check property' tool in Cabri allows to check if a property is true or not, for example if two lines are parallel or if they are perpendicular, etc.

<sup>5</sup> It is very difficult to obtain two parallel lines just by eye (the same for right angles) because of the internal precision of the software.

<sup>6</sup> All over the process the students keep modifying the initial quadrilateral ABCD into different shapes, but never construct new quadrilaterals using their properties.

<sup>7</sup> Answering question 2.

asks: *can it be a parallelogram then?* (#82). They discuss whether it can be a parallelogram or not, with Alice saying it can because it can be a square, which is a particular parallelogram, and Will saying that it cannot be a 'non particular' parallelogram. A brief attempt to measure the sides of the quadrilaterals, using the Cabri measuring tool, follows without success (#89-#98).

#### H.2.4 Episode 4. New exploration and explaining conjecture C2 to the teacher

(#99-#142, time: 0.12.41-0.14.10)

The inside quadrilateral is defined with segments (#99-Figure H.4). The bisectors are hidden.

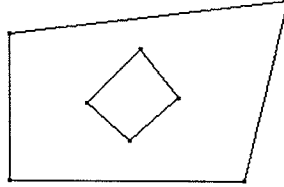

Figure H.4. A&W, Ep.4, #99

The teacher comes and interact with the students (#110, #116 and #120), asking them to explain him what they have produced. After Will tells him that they know that *two pairs of lines in the middle of the quadrilateral* (#113) are parallel, the teacher makes them reflect on the relationships between the two quadrilaterals: *this says about HKLM but what does it tell you about ABCD?* (#120). In #127 the generation of the conjecture about the parallelogram begins and ends in #138. They start from a particular parallelogram and say that *these two (bisectors) are parallel...right OK.* (#131). Then one side of the parallelogram is moved up and they say that *they are always parallel!* (#133-#134). Finally they re-formulate conjecture C2: *so whenever the outside lines are parallel the inside ones are* (#137).

C2

#### H.2.5 Episode 5. Writing down conjectures

(#143-#167, time: 0.14.11-0.16.50)

The teacher asks them to write down their conjectures. Alice makes ABCD a rectangle first (#146-C3) then a square (#148-Figure H.5- C1). Meanwhile Will takes a piece of paper (#149) and writes down C2: *when ABCD is a parallelogram HKLM is a parallelogram* (#151), as Alice says it. They use the 'check property' tool in order to check if ABCD is a square (#154-167) when inside there is a point, by checking if the vertices are equidistant (i.e. the sides of ABCD are equal).

C3

C1

C2

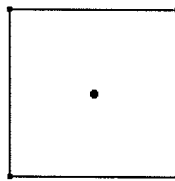

Figure H.5. A&W, Ep.5, #148

#### H.2.6 Episode 6. Generation of the conjecture C5

(#168-#201, time: 0.16.51-0.21.00)

Alice reads question 3 (#168): *which hypothesis on ABCD do you need in order to have this (a point)?* From #170 to #201 they work on this. They start from a square (not constructed but obtained by dragging ABCD) then drag and get Figure H.6, which is the starting point of the generation of the conjecture.

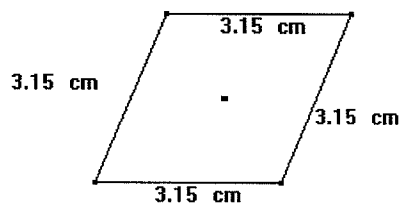

Figure H.6. A&W, Ep.6, #173

The first observation is *oh no it's not a square...it's a rhombus* (#172). Then Alice makes a first conjecture **C5**: *surely it would work if opposite sides are equal* (#176). Then a bit of justification for this conjecture is presented by Alice: *well any parallelogram will have opposite angles equal wont' they so the bisectors would join on the same line* (#179). They ask themselves why this would happen (#182). In #184 Alice reinforces her observation about parallelograms. This formulation contains already a justification bit: *For any parallelogram opposite bisectors will be on the same line* (#184). At this point she checks her conjecture by dragging in Cabri. She moves C and B<sup>8</sup> so that ABCD becomes a parallelogram, then she stops, seeing that inside there is not a point (#185-Figure H.7).

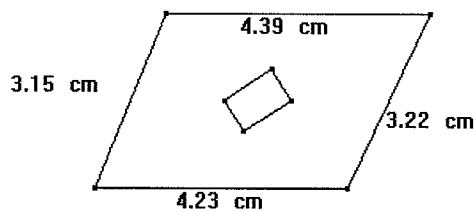

Figure H.7. A&W, Ep.6, #185

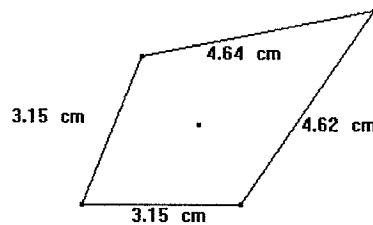

Figure H.8. A&W, Ep.6, #199

Will then says *all sides ought to be equal* (#189- **C6**). Dragging makes them formulate a new conjecture for *HKLM to be a point ...when it's two sides next to each other then must be equal* (#190 - **C5**). Finally they drag and get a kite, and they re-formulate conjecture **C5**: *that'd be a kite* (#198) and *that's a point isn't it? Wow!* (#200 - Figure H.8).

### H.2.7 Episode 7. Starting to prove C5

(#202-#286, time: 0.21.01-0.32.59)

After formulating **C5**, they mention the fact they have to prove it (#202). It seems that here it is the official starting point of the construction of proofs. They go to paper (#205), but they do not write anything down. The proof they construct is oral [for an easier comprehension of the proof the students construct I insert a figure with letters (Figure H.9), which however is not the one the students drew].

<sup>8</sup> C and B being the two vertices at the top of the quadrilateral.

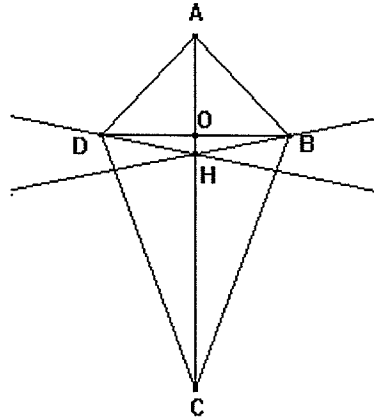

Figure H.9. A&amp;W, figure for the proof.

In #208-#210 Will states what they have to prove: *so you have one line going straight through the middle obviously (AC). Then those two (the other two angle bisectors) must meet in the middle again.* The proof then goes on with observing some properties on the figure: opposite equal angles ADC and ABC (#214), *it's like an isosceles triangle (pointing at BDC) (#221), not necessarily the bisector is the diagonal (#234), congruent triangles ADC and ABC (#240).* Alice then says *suppose if you said that in a kite they would go through a point you would then say the bisector is perpendicular ... no ... no ... you would only say they will meet along this line (#240).* In #245 Will states what they have to prove: *We are trying to prove the bisectors cross in the middle.* The proof shows that triangles CDH and CBH are congruent so DH equals HB, so H belongs to AC and they all meet in the same point. The words used by Alice are: *I suppose you can do it with ...if you do it with the diagonal across there then you can use congruent triangles or similar whatever, because they have got the same angles, the same sides... and those angles must be the same. and those angles must be the same therefore that side, well they have got two sides the same so the other has to be the same, doesn't it, yeah, two sides and then two...yeah so therefore those two are the same so it cuts.* This (#276-#284) constitutes a proof (P5) for the conjecture C5 according to the students.

P5

### H.2.8 Episode 8. Explaining the proof P5 for C5 to the teacher

(#287-#320, time: 0.33.00-0.34.29)

When the teacher asks Alice and Will what they have proved so far, they say the conjecture about the kite (C5): *we proved that if it's a kite then they meet at a point (#289).* Will summarises what they did: *right, we proved that these two bisectors, that one and bisector of that angle and are on the same line (#300).* Alice goes on: *yes you have to prove...yeah you have just to prove that the distance from (pointing on the figure) from each bisectors on the corner to the middle is the same so you can prove that they cross along the centre line (#310).* And they finally explain their proof P5 to the teacher (#314-#316). Will: *Well we proved that these two triangles (CDH and CBH) are congruent because they've got the same angles, sides (indicates with the pen almost without saying), Alice: because that angle is the same as that (CDH and CBH), Will: therefore that line is the same length as that line (DH and HB) (two pens on the figure).* The teacher suggests they could have used the fact that AC is the perpendicular bisector of DB. [Their proof is as follows: they prove that triangles CDH and CBH are congruent, so DH and HB (the bisectors) are congruent and this means that H belongs to the perpendicular bisector of DB, that, since ABCD is a kite, is AC].

C5

P5

### H.2.9 Episode 9. Writing down conjectures and proofs

(#321-#398, time: 0.34.30-0.55.00)

They write down on the Cabri screen (#326) C5: when ABCD is a kite, HKLM is a point and C2, while saying it: *when ABCD is a parallelogram so is HKLM (#330).* Then they write a generalised conjecture C6: *if all 4 sides of ABCD are equal, HKLM is a point (#334),* which contains both the case of the square (C1) and the case of the rhombus.

C5

C2

C6

**a. Writing the proof for the conjecture C5 (if ABCD is a kite then HKLM is a point)**

Alice decides to write the proof P5 for the conjecture C5 on paper and while constructing the proof she makes the sketches of Figure H.10 (the figures numbers show the order in which the sketches were drawn).

C5

Alice  
27/9/99  
(groups)

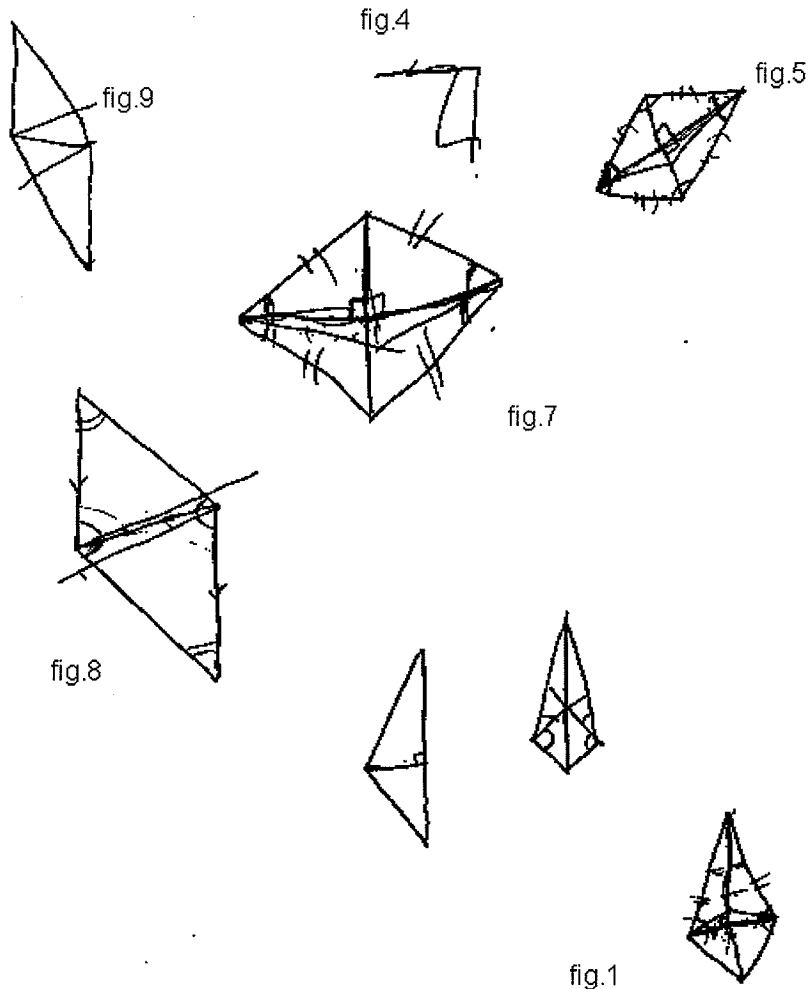
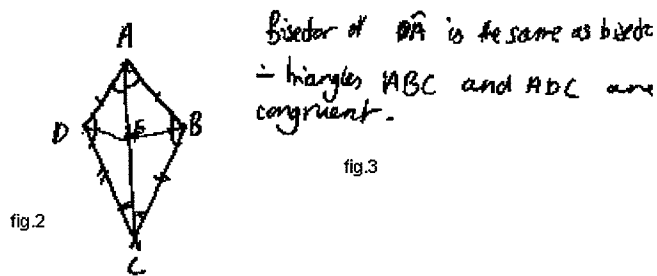

Figure H.10. A&W. Alice's sketches on paper while constructing the proof for conjecture C5.

In #351 Alice reminds herself what they have to prove: the distance from any point along AC to B and D is the same. You've still got to prove that. And then Will transforms this into: shall we try to prove that ABC and ADC are congruent? (#354). Lines #355-#364 constitute a proof for the

P5

congruence of the triangles for them, as Alice says *right?* so triangles  $ABC$  and  $ADC$  are congruent (#364). Will writes down on OHP (#372) C5: 1) in a kite angles bisectors meet at a point, and a slightly different formulation for C6: 2) if ABCD is square or rhombus then angle bisectors meet at a point. Alice is thinking about how to prove this last conjecture about the rhombus and transform the thesis into proving that the two bisectors are the same line (#376). However she cannot finish because the teacher calls them for the final presentations to the classroom. They still write down the big conjecture (#395), that if two adjacent side are equal then  $HKLM$  is a point (#397). So conjecture C7, which includes C6 and C5, is written down as: If there are two pairs of adjacent and equal length sides then  $HKLM$  is concurrent (kites, squares, rhombi). C7

Figure H.11 shows what they wrote on the OHP.

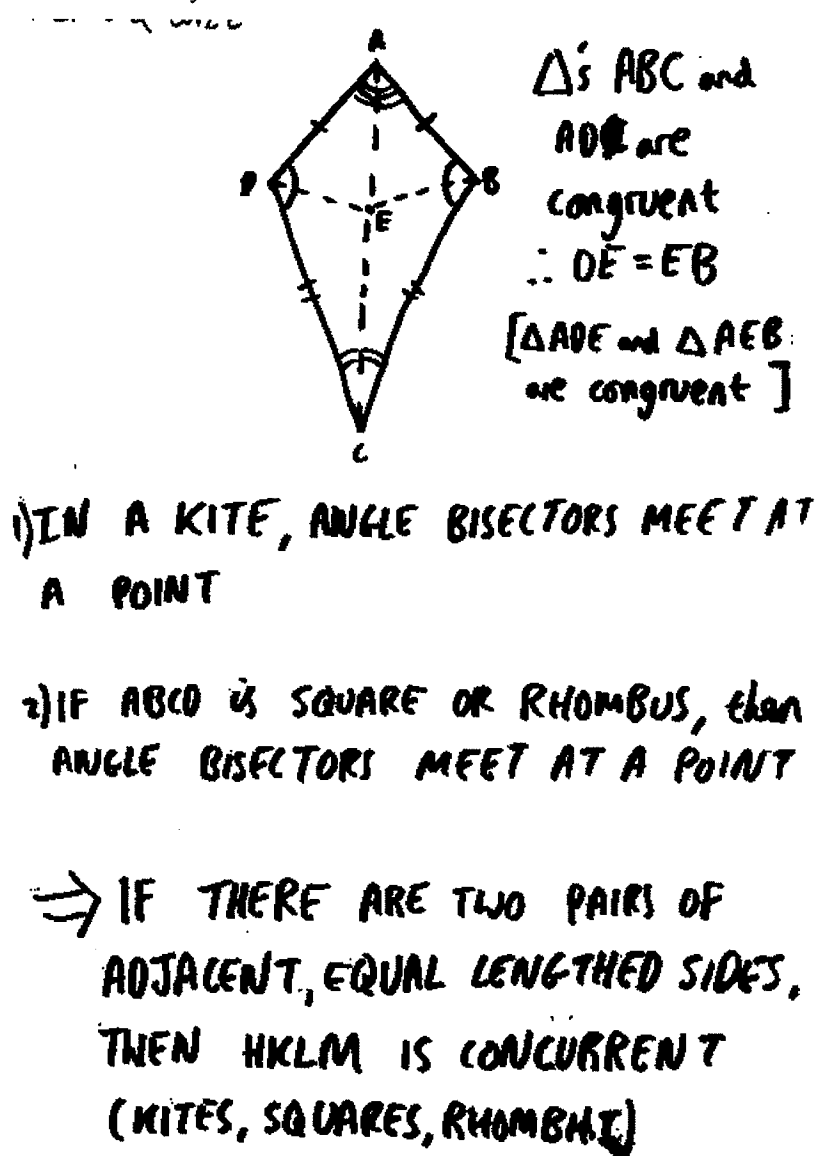

Figure H.11. A&W. OHP the students presented to the whole class for conjecture C5 and proof P5

## H.2.10 Episode 10. A new proof: the case of the parallelogram (C2)

(#399-#419, time: 0.55.00-0.59.59)

Before the final presentations, Alice & Will construct the proof (#399 - #411). for the case of the parallelogram C2. In #405 Alice draws on paper (see fig.8 in Figure H.10) the key element for the

proof (the diagonal AC), which then centres around showing that the angle bisectors are parallel. The proof goes very quickly, as Alice says that *I know how you do it right?* (#407). Alice: *If you draw the diagonal there right?* (she draws it) *Then you know that that angle there, the big one, is equal to that angle there (between sides and diagonal)... so that tiny bit equals that tiny bit. Will: because that's equal to that Alice: yeah. Therefore those alternate angles are equal therefore those two are parallel (the bisectors)* (#407-#411- P2). Then Alice writes this proof P2 down on OHP (Figure H.12).

P2

WHEN ABCD IS A PARALLELOGRAM, SO IS HKLM.

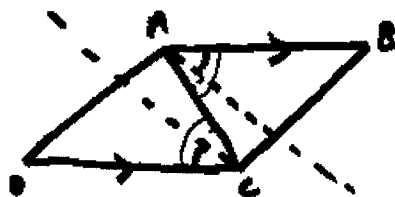

AB//CD  $\therefore$  red angles are equal  
 .... are bisectors and  $\hat{A} = \hat{C}$  (opposite angles equal)  
 $\therefore$  black angles are equal  
 $\therefore$  green angles are equal  
 $\therefore$  bisectors are parallel

DO for other 2 bisectors  
 $\Rightarrow$  HKLM is a parallelogram.

Figure H.12. A&W. OHP the students presented for the conjecture C2 and proof P2

### H.2.11 Episode 11. Presentations

(#420-#450, time: 1.00.00-1.15.00)

The episode starts with the organisation of the presentations (#420). Alice starts presenting the proof P2 to the classroom: *When ABCD is a parallelogram so is HKLM ....and then you do it again with the other two bisectors and it works. And then you get that the pairs of bisectors are parallel so it must be a parallelogram. It might be a rectangle but it is still a parallelogram* (#422, #424). Later on, Will explains the proof P4 for the case of the kite, using the OHP in Figure H.11: *well basically because those two angles are the same, ADE, no EAB and DAE (wants to use hands to point on the figure on the OHP) are the same at the top, those two sides are equal (AD and AB), those two angles are equal (EDA and EBA). Teacher: how did you get that? Alice: because DE and BE are bisectors* (#438-#440).

P2

P4

### H.3 SUMMARY OF CONJECTURES AND PROOFS

Table H.1 summarises the conjectures and proofs made by Alice and Will over the proving process. The numbers #n refer to the lines in the transcript where the conjecture or proof was being constructed. As we can see, these students do not get to the formulation of a general conjecture for the case in which HKLM is a point. However they still produce many conjectures and they succeed in proving C2 and C5, which is a generalisation of C1, C4 and C6.

Conjectures	#	#	Proofs
<b>C1</b> <sup>9</sup> If ABCD square, then HKLM point	12, 13, 69	No proof	<b>P1</b>
<b>C2</b> If ABCD parallelogram, HKLM parallelogram	36, 45, 51, 118, 131, 133-136, 137, 151, 330	407-411	<b>P2</b>
<b>C3</b> If ABCD rectangle, HKLM square	25, 66, 72-78, 79	No proof	<b>P3</b>
<b>C4</b> If ABCD rhombus, HKLM point	176, 177, 186-187	No proof	<b>P4</b>
<b>C5</b> If ABCD kite, then HKLM point	190, 198-200, 289, 326	276-284, 314-316, 355-364	<b>P5</b>
<b>C6</b> If all 4 sides of ABCD are equal, HKLM is a point	189, 334	No proof	<b>P6</b>
<b>C7</b> If there are two pairs of adjacent and equal length sides then HKLM is concurrent (kites, squares, rhombi)	398	No proof	<b>P7</b>

Table H.1. A&W. Conjectures and proofs

Table H.2 below shows that proofs are produced towards the end of the process. First the students formulate all conjectures and then they decide to start proving some of them and the conjecturing process stops, apart from writing a generalised conjecture (C7) from the previous ones.

<sup>9</sup>The formulation of the conjectures is not necessarily the one made by the students.



Ep	C1	C2	C3	C4	C5	C6	C7	#
Ep2	○							12
	○							13
			○					25
		○						36
			○					40
		○						45
		○						51
			○					54
			○					66
	○							69
Ep3			○					72-78
			○					79
Ep4		○						118
		○						131
		○						133-134
		○						136
		○						137
Ep5		○						151
Ep6				○				176
				○				177
				○				186-187
						○		189
					○		190	
					○		198-200	
Ep7					●			276-284
Ep8					○			289
					●			314-316
Ep9					○			326
		○						330
						○		334
					●			355-364
						○		397
						○		398
Ep10		●						399
		●						407-411

Table H.2. A&W. Evolution of conjectures and proofs

○<sup>10</sup> = conjecture, ● = proof

<sup>10</sup> The symbols ○ and ● indicate either the moment in which the conjecture or proof was made or the moments in which students worked towards that conjecture or proof.