



HAL
open science

Toward a Web based environment for Evaluation and Design of Pedagogical Hypermedia

Philippe Trigano, Ecaterina Pacurar Giacomini

► **To cite this version:**

Philippe Trigano, Ecaterina Pacurar Giacomini. Toward a Web based environment for Evaluation and Design of Pedagogical Hypermedia. Educational Technology & Society Journal, 2004, Volume 7 n° 3, pp.21-37. hal-00004237

HAL Id: hal-00004237

<https://telearn.hal.science/hal-00004237v1>

Submitted on 11 Feb 2005

HAL is a multi-disciplinary open access archive for the deposit and dissemination of scientific research documents, whether they are published or not. The documents may come from teaching and research institutions in France or abroad, or from public or private research centers.

L'archive ouverte pluridisciplinaire **HAL**, est destinée au dépôt et à la diffusion de documents scientifiques de niveau recherche, publiés ou non, émanant des établissements d'enseignement et de recherche français ou étrangers, des laboratoires publics ou privés.

Toward a Web based environment for Evaluation and Design of Pedagogical Hypermedia

Pr. Philippe C TRIGANO

Université de Technologie de Compiègne (U.T.C.)
UMR CNRS 6599 Heudiasyc
BP 20529 60205 Compiègne FRANCE
Tel : (33) 3 44 23 45 02
philippe.trigano@utc.fr

Ph.D Ecaterina PACURAR-GIACOMINI

Université de Technologie de Compiègne (U.T.C.)
UMR CNRS 6599 Heudiasyc
BP 20529 60205 Compiègne FRANCE
Tel : (33) 3 44 23 45 02
egiacomi@hds.utc.fr

ABSTRACT

We are working on a method, called CEPIAH. We propose a web based system used to help teachers to design multimedia documents and to evaluate their prototypes. Our current research objectives are to create a methodology to sustain the educational hypermedia design and evaluation. A module is used to evaluate multimedia software applied in educational context. We structured a knowledge base composed from a list of evaluation criteria, grouped in six themes: general feeling, technical quality, usability, scenario, multimedia documents, and didactical aspects. We insisted on multimedia particular aspects: we thoroughly studied the specificity of multimedia documents (investigating various fields such as photography, typography, picture semantics, cinema...). We also evaluated the way multimedia elements are gathered to prepare the reading acts. We finally determined specific criteria for pedagogical aspects, associated to the previous approaches. A global questionnaire joins all these modules. In this paper, we present the first two modules, EMPI and SP/UL/FC (a method for designing pedagogical hypermedia), and an application of distant teaching (and distant learning), commenting the first results of this experiment. We conclude by a short presentation of the third module, on which we are still working.

Keywords: Learning on the web, Evaluation, E-learning, Instructional design.

1. Introduction

The role of knowledge transfer in our society becomes more and more important. Different ways of teaching appear, concerning more and more people, beginning earlier and earlier and ending later and later. We do need new tools to answer this new demand. Learning software could be particularly useful in case of distance learning, along-the-life learning, very heterogeneous skills in classes, children helping (etc.).

We are working on a method, called CEPIAH, for the design and the evaluation of pedagogical hypermedia. We propose a web based system used to help teachers to design multimedia documents and to evaluate their prototypes. Our tool integrates three main modules:

- Design Help: SP/UL/FC, a method for designing pedagogical hypermedia (Crozat, 2002), on which we have been working from 1999 to 2002,
- Evaluation Help: EMPI (Evaluation of Multimedia Pedagogical and Interactive software), an interactive software built from 1997 to 2001, for evaluating multimedia interactive software, by using dynamic navigation in a set of questions (Hû & Trigano, 2000),
- A set of Pedagogical Models and patterns, by using pedagogical scenario (work in progress).

In this paper, we present the first two modules of our CEPIAH method, and we will conclude by a short presentation of the third module.

CEPIAH Method

In order to guide and help the educational Web sites authors in the conception/evaluation process of their prototypes, it is especially interesting to propose them interactive guides. Among the existent interactive guides, only few offer a good content structure or an appropriate navigation in their system. For example, the sites CINEMA (CINEMA, 2003) and W3 Educatif (W3 Educatif, 2003) consist mainly of a section "Course" and of a section "Evaluation". Such structure does not facilitate the navigation between these parts during the conception process. We propose a method for the design and evaluation help for the educational hypermedia having the following characteristics: the flexible navigation in the environment improving the iterative conception/evaluation process, and an offer of predefined models of educational web sites.

Our CEPIAH project has as final goal: a tool to help **teachers to design instructional Web sites**. We want to valorise at maximum the support characteristics in correlation with the particular pedagogical contexts and Human-Computer Ergonomic Multimedia Interface.

In order to help the teacher to design his instructional Web site, we developed an interactive guideline accessible on the Web.

2. Design Help

The first module of our CEPIAH Method, called Design Help, is based on the SP/UL/FC methodology (Crozat, 2002) for the design of multimedia software for education (distant teaching and distant learning), by **using the Internet**. Authors and users of multimedia educational software lack experience in this recent field. We propose to distinguish between three main approaches: the first one centred on documentary discipline, the second one on multimedia one and the third one on pedagogy. This distinction will lead us to suggest integrating these three ways of thinking into one single methodology.

2.1 Three ways of thinking

The documentary approach is based on the organisation of information in the documents. Generally these approaches are based on the separation between the logical structure and the physical one. That means that authors define logical structures, and that editors use this structure in order to present information to the readers. The logical structure can stand at two levels: to determine what can exist inside an information node and to determine what kind of relationships can exist inside a set of nodes.

The bases of multimedia approach is to search the reason why using digital documents instead of normal ones. For each problem, this approach tries to find the supplements the support could bring.

2.2 Integrating the three approaches

Digital documents bring new potentials of information representation, based on dynamic calculation. The position we adopt implies that:

- We need logically structured and annotated documents in order to control their manipulation inside a complex hyperdocument.
- We need multimedia methodologies in order to benefit from the support potentials (multimedia and dynamic interaction) and deal with readability of multimedia documents.
- We need pedagogical design principles and experiments in order to provide useful tools that profit from the support to improve the training process.

Because of the non-linearity of the information representation in a digital support, we propose to model an hypermedia as a graph, *i.e.* a set of nodes and links between them. The first implication of such a representation is that the reading depends on the way the nodes are accessed (*i.e.* computed). Indeed, a node is a computation-unit. Since books or videotapes impose the reading process (one page, or sequence, before the other), digital supports do not: the reader is expected to build by his own a proper linearity. Therefore, there is no guaranty on what the user has accessed before, and what he will access then, while reading a computation-unit. We submit the following hypothesis in order to deal with this problem: the information representation in hypermedia should be based on **information-units** corresponding to computation-units. We define an information-unit as a node of the graph, the reading of which is necessary and sufficient in order to understand a concept. This implies that the information-unit is indivisible (no hyperlinks inside it for instance) and that no hypothesis should be done, while drafting, on the links between the units.

Two questions emerge from this representation: How to manage the interaction between a set of media that compose an information unit? How to manage the interaction between a set of information-units that compose an hypermedia? The internal structure of an information-unit represents the explicit logical structure of different kinds of multimedia elements that compose it, and the relationships between these multimedia elements. The external structure of an information-unit represents its explicit conceptual links with the other information-units that compose the hypermedia. Thus, our purpose is to integrate documentary, multimedia and pedagogical approach in one single methodology.

The part concerning the module for the Design Help of an educational web site is structured on the *information units*. In our model we imagined a course structure based on this principle. In this structure the body of every unit consists of elements of several text blocks.

We gathered all the information that we want to take into account in a knowledge base, with a hierarchical tree structure, based on: themes, meta-criteria and criteria. We propose this structure because we are not interested only in the « ergonomic » aspect, but also we are interested in the technical quality, the pedagogical structure etc. That is why we introduced the notion of “theme”. Furthermore we think that choosing this structure enables a « finer » content division (« chapter », « section » and « paragraph » type like) in order to respect the Human-Machine Interface ergonomic rule of « maximum three clicks ». That will improve the legibility and will help an educational hypermedia designer to guide himself during his conception and evaluation work. The themes position in this structure is at the highest level. Each meta-criteria consists of criteria. We identified six main themes:

- The **Project Management** theme determines the design and development stages for a pedagogical hypermedia product. Thus, the meta-criteria decomposing this theme deal with a previous analysis (demands, tasks file, necessity analysis etc.) on the juridical and financial aspects of design procedure for a teaching hypermedia product.

- The **Technical Quality** theme regards the soft elaboration: fastness, compatibility, download etc. Finally, for a good pedagogical Web site utilisation, the user should not encounter technical problems due to certain malfunctions of the system. So, the educational site designer must consider the technical aspects as: an image downloads time, a document or application download.

- The **Web Ergonomic** theme gives general instructions for an ergonomical design of IHM (Human-Machine Interface) and the Web sites. Among the meta-criteria this theme consists of, we remind: the manoeuvrability, the guide through out, the navigation, etc. To identify these suggestions we inspired ourselves from the works of (Scapin 1997; Nielsen 2000), (Vanderdonck 1994).

- The theme: **Elements of Human Machine-Interface** deals with the graphic design elements and multimedia elements (such as image, sound etc.). These elements should be the most adapted for a pedagogical hypermedia. Therefore, the indications cover the aspects of graphical presentation (colour, typography, icons etc.), of text elements (tables, lists etc.), the most used in learning hypermedia environment. The indications about the sound, image and video integration, are equally covered by this theme (Nielsen 2000; Preece 1996).

- The **Pedagogical Structure** theme concerns the presentation quality, the content structure and the pedagogical tools (reading tools, interactive tools) appropriate to an hypermedia learning environment. Finally, the content structure must highlight the main logical lines and the main links between various content elements. At this level the different structuring techniques are a priority. The schema facilitates the perception, the comprehension, the memorisation and in conclusion the learning process (Bruner et al. 73).

- The **Pedagogical Environment** theme concerns the instructions upon the pedagogical multimedia characteristic elements such as, the suggested pedagogical activities for the learners and also the tools that enable the communication, the evaluation and the supervising of the learners during the instruction process (Depover 1998).

A text block is an information unit of four elements: definitions, detail accuracy, example lists and annexes (see figure 1).



Figure 1. Design module

The definitions describe the recommendations to be considered by the course author during the conception process. These recommendations correspond to different domains such as: IHM ergonomic, pedagogical multimedia environments etc. The detail accuracy provides a detailed view for each recommendation of the course.

The examples can show what the author should avoid- negative examples, and/or what he has to consider during his course conception - positive examples. To illustrate, we present bellow a negative and a positive example (figure 2), connected to the course atom Graphical Presentation.

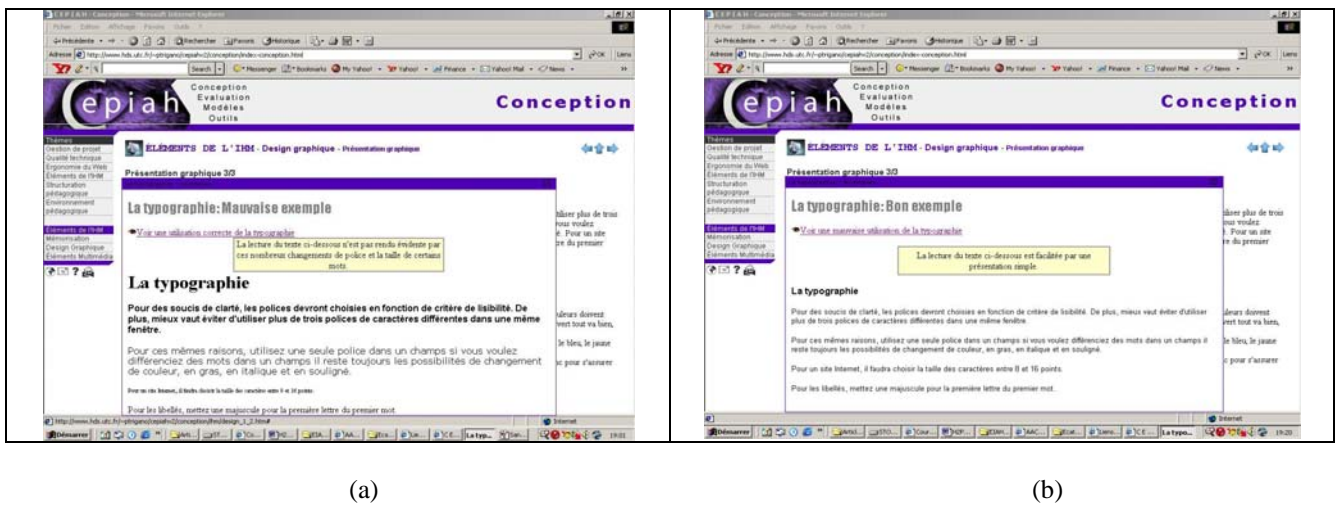

Figure 2. Negative example (a), positive example (b)

The annexes reveal information about the used sources for a module of educational Web sites design help and extra references on request.

3. The EMPI Module for Evaluation Help

We present now the second module, a methodological environment we are building in order to assist designers from specifications to final evaluation.

This second module is directly linked to the first module for Evaluation Help (EMPI). The idea consists in the possibility of the pedagogical web sites authors to evaluate their prototype during designing process. This evaluation enables them to find their design defaults in order to improve the bad points.

3.1 The EMPI Module

Among all existing methods or techniques used to evaluate software, it is particularly interesting to select questionnaires or lists of recommendations. They are easy to implement, usable without help of a specialist and they can evaluate any kind of observable criteria. And so, they are well adapted for the multi-disciplinary evaluations, done by software users and not by software designers. However, the use of such questionnaires have two major inconveniences: results are depending on the subjectivity feeling of the user, and the evaluation is generally done out of the real conditions of use.

When we use guidelines or questionnaires to evaluate software, some problems can appear: the number of questions increases and thus the duration of an evaluation becomes too long; sometimes evaluation becomes too subjective to be relevant; the choice of questions becomes complex, and so on. To try to solve these problems, in educational context, we have conceived a method that dynamically builds an evaluation: precision and depth of analysis, choice and weight of questions, are done during the evaluation. In our method, the evaluator is free to explore questions and to adapt the base to his case. He is guided, helped and confronted to his own subjectivity with an aim of building the most relevant evaluation.

A subjective evaluation (general evaluation), linked to the use of a questionnaire (deep evaluation), is taken into account, capitalized and then compared to the objective evaluation, in order to help the human evaluation. This method has been implemented in a tool, usable during the evaluated software exploration. There are a lot of domains concerned by the evaluation of pedagogical software. If we want a good accuracy in each theme, the set of questions can quickly become very large. Thus, it is important to have a structured tree of questions to improve the use and the modification of this base.

Structure

Questions are gathered into a hierarchical structure, containing six main branches, each branch having three levels (Figure 3). In this way, there are six general themes, divided in criteria, each criteria is divided into subcriteria and then into questions. These themes come from several models of pedagogical software or student activity theory (Linard & Zeiliger, 1995; Linard et al. 1998).

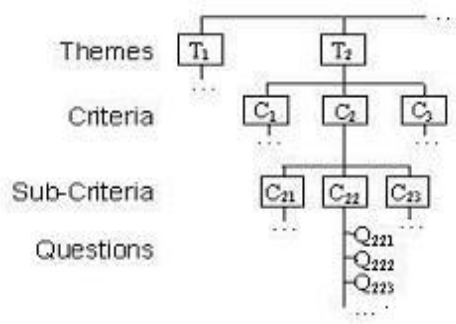

Figure 3. Global structure

In the EMPI method, we have been using six main themes:

- **General feeling** theme concerns what users think about the software.
- **Technical quality** theme allows the evaluation of the technical realisation.
- **Usability** theme corresponds to the ergonomic quality of the interface.
- **Multimedia documents** theme is associated to the quality of texts, sounds, and images.
- **Scenario** theme deals with writing techniques used to design information.
- **Pedagogical tools** theme finally inspects the pedagogical possibility offered by the pedagogical software.

Questions

In order to help evaluators, each question was written as a simple model:

- The formulation must imply evaluator: We prefer a question like "Did you see something...", rather than "Does the

software display...".

- Help is given with each question. This help contains several parts:
 - A reformulation of the question.
 - A longer explanation.
 - Some examples and bibliographical references, if possible.

Some questions are subdivided in two phases: the first one to characterise the software's situation, and the second one to evaluate the relevance of this situation. For instance, in order to evaluate the structure of the software, we will firstly determine what kind of structure is concerned (linear, arborescent, etc.) and then if it is a correct one.

The evaluator, with a synthesis of the instinctive and calculated marks and the correspondent ratings, is given a **final mark** by the evaluating system. But the human evaluator keeps ultimately the capacity of judging the final mark of each criterion.

A **structured and contextual help** is provided for each criterion and question, in order to have the most objective evaluation. This help allows to reformulate the questions, concepts' definition, theoretic fundamentals explanation and some characteristic examples. The **weight of questions** on a criterion can be either essential or secondary, to express the fact that some aspects or defaults are more important than others.

We propose in the following parts to develop each theme and criterion.

General feelings

Software provides a general feeling to the teachers. This feeling is formed from graphical choices, music, typographic, scenario structure. The important fact is that the teacher's feelings deeply affect the way he learns. Our experiences revealed that the general feeling is mainly instinctive, easily describable by the teachers, quite homogeneous inside a large population, and long lasting.

In order to better understand this phenomenon, we studied various fields, such as visual perception theories (Gibson, 1979), image semantic, musicology, cinematography strategies... With these theories we managed to submit a list of six pairs of criteria. This list comes from an evaluation database that was analysed by a documents indexing method (Lamrous & Trigano 1999). We also compare this result with theoretical approaches: visual perception theory, for example. These impressions show several characteristics:

- They are *instinctive*: Users provide them without any assistance.
- *Describable*: Users are able to describe them with a few adjectives.
- *Homogeneous*: They are concordant between users.
- *Persistent*: They endure in time and influence further use.

This list allows the evaluator to provide a description of his impressions. He indicates what he feels for each couple of impressions. For example: very diverting, reassuring or very reassuring. There is no "neutral" evaluation to incite the evaluator to give a real opinion. They make it possible to describe quite satisfactorily what one feels in situation of use of learning software.

We shall specify that this theme is particular in the following senses: the criteria are provided by opposite pairs; they are expected to be neutrals, in order to describe the feelings, not to judge them directly.

We propose to him some couples of impressions which will enable him to give a ruling on (Figure 4): Reassuring/Disconcerting; Luxuriant / Moderate; Playful / Serious; Active / Passive; Simple / Complex; Innovating / Traditional.

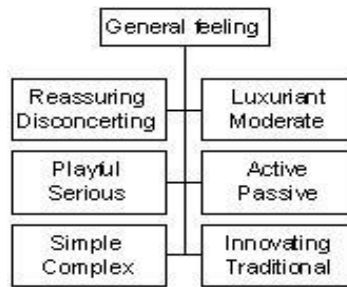

Figure 4. General feelings

The goal is to capitalize, at the beginning of the evaluation, the impressions that the evaluator feels during the use of the software.

Technical quality

Good software is first of all working software. So we decided to begin by giving the technical criteria that software has to satisfy (Figure 5).



Figure 5. Technical quality

When one uses slow, hard to configure or bugged software, the reject is generally obvious. Literature, in software design, abundantly deals with these aspects. We submit here one proposition of criteria organisation. For more details, see (Hû et Trigano, 2000).

Usability

A large set of criteria exists in the field of usability of user interfaces. In our context, our problem was to find a compromise between general criteria (Ravden et al. 1989) and to specify the rules (Vanderdonckt, 1999).

To build the following set, we used in depth the INRIA works (Bastien & Scapin 1997), adapting their criteria to our multimedia and educational context (Figure 6). They are more deeply described in (Hû et Trigano 2000) and (Hû et Trigano, 1999).

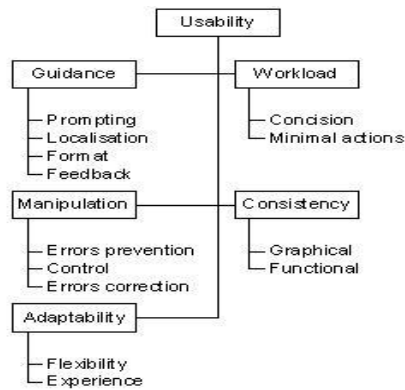

Figure 6. Usability

Multimedia documents

Texts, images and sounds are the constituents of the learning software (Figure 7). They are the information vectors, and have to be evaluated for the information they carry. But the way they are presented is also an important point, because it will influence the way they are read. To build this part of the questionnaire, we had to explore various domains, such as the pictures' semantics (Type et Frommer, 1985), the photography, the audio-visual (etc.).

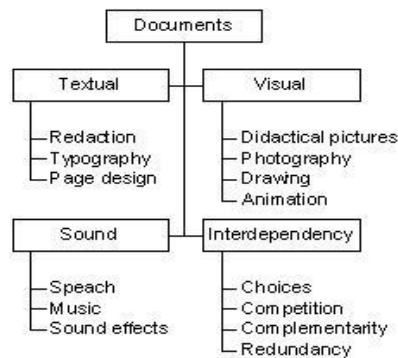

Figure 7. Multimedia documents

Our works also points out that in a multimedia environment each document is always presented along with other documents at the same time. The set of documents presented together generates a web of relations that influences the global signification. These interdependencies between documents are as important as each separate characteristic of the document in the process of interpretation.

Scenario

We define the scenario such as the particular process of designing documents in order to prepare the act of reading (Figure 8). The scenario does not deal directly with information, but with the way they are structured. This supposes an original way of writing, dealing with non-linear structure, dynamic data, and multimedia documents.

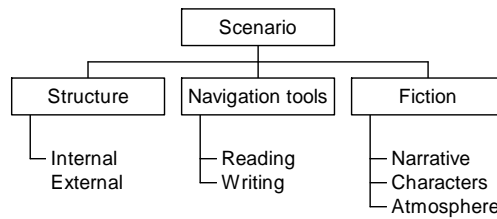

Figure 8. Scenario

Our studies are oriented toward the various classifications of navigation structures (Sabry-Ismaïl et al. 1997), and the fiction integration in learning software (Sanchez et Lumbreras, 1997).

Didactic

Literature offers plenty of criteria and recommendations for the pedagogical application of computer technology (Park et Hannafin, 1993). We also used more specific studies, such as works on interaction process (Vivet, 1996), or practical experiences. This last theme is expected to describe the specific didactical strategy of the software (Figure 9).

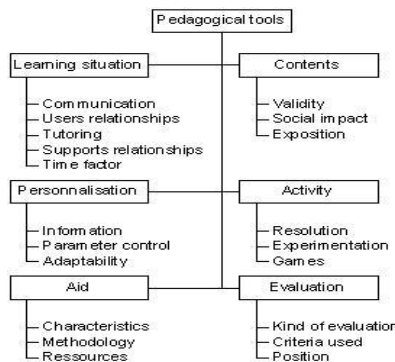

Figure 9. Pedagogical tools

Our goal is not to impose one or other strategy, but stating which is the better one. This normalising approach can not be applied (whereas it was possible for usability or technical aspects), for two main reasons: We do not have enough experience with learning software to impose a way of doing things and the definition of a didactical strategy is totally context-dependent. That means that our criteria only provide a main grid to have a systematic approach in determining what is relevant in one particular case.

After this presentation of the questionnaire, we now explain how to use it in an evaluation.

3.2 The Evaluation Step

A Dynamic Navigation

An important point of our method is the possibility to use a dynamic navigation into the questionnaire structure during an evaluation. Thus, at each level, and for each question, the evaluator can (Figure 10):

- Delete a criterion or a question and all the associated sublevels, if this criterion or question, is not relevant for him.
- Go thoroughly into a node or not. If the evaluator is very competent in this domain, he will not have to develop sub-levels, and will only answer to this criteria level. That means that the evaluation can directly evaluate each criterion, instinctively, or go deeper in the criteria structure.
- To modify node's importance of each part of the tree, and modify the weight of criteria, sub-criteria and questions in calculations.

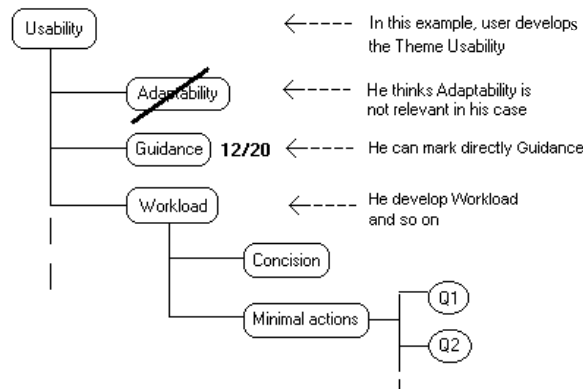

Figure 10. An example of navigation in our structure

Thus, the navigation into the questionnaire is not fixed. It depends on the evaluator's competencies and needs: The evaluator will be able to adjust the set of questions to his own situation. Moreover, the structure of the questionnaire may automatically be modified by the answers given by the evaluator. Then the software dynamically chooses the questions depending on the previous answers.

Use of Evaluator's Subjectivity

The seduction and the pleasure have an evident impact on the student's motivation and thus on the way of learning. On one hand, the evaluator, during a short period of time, is seen as a final user. Then, he can give his general feelings on the software he has tested. On the other hand, our evaluator knows sufficiently the final users and we think that their opinions are relevant. Moreover, all the evaluators are not specialists in ergonomics, in educational sciences or in multimedia design, and it is impossible to develop a questionnaire with all the characteristics of every software application in all educational contexts. By enabling an evaluator to give his judgment, we add new chances to detect a default felt by the evaluator, even if they can not identify the exact reasons of this default.

For all the themes, criteria or sub-criteria, the evaluator can give a mark "instinctive" on the scale "- - ; - ; + ; + +". Because the evaluators do not have the required competencies in all evaluated fields, help must be provided. This help is divided in three parts: A reformulation, an illustration and a deepening. We obtain an information of how the teacher perceives the reality. This result can be compared with the objective evaluation of this same reality by the questions themselves.

Calculation

Once the questionnaire is filled out, the method gives a report enabling the evaluator to see a global view of his evaluation. A notation has been done at any point of the tree: Themes, Criteria, and Sub-criteria. For a question, the answer corresponds directly to the mark. In order to detect major defaults, some marking could be not linear (Figure 11).

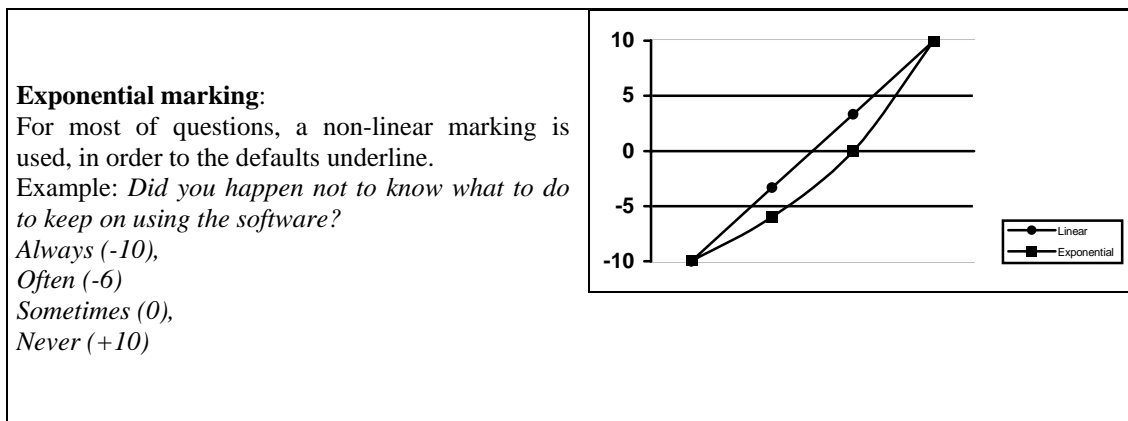

Fig. 11 Example of exponential marking

Final Mark

As we already mentioned, our objective is to help an evaluator to use a questions base and not to judge for him. Thus, and contrary to other approaches (such as (MEDA, 1990) for example), the final mark will be proposed by the method: The evaluator can modify it if he wishes. To help him in this step, some marks and indications are proposed to him for each theme, criterion and sub-criterion:

- *A calculated mark*: It results from the questions themselves.
- *An instinctive mark*: It corresponds to the instinctive mark given to this level by the evaluator. A more global instinctive mark is also given; it is an average between the instinctive mark of this level and the ones of lower levels.
- *A correlation index*: It measures the similarity between instinctive mark and calculated mark.
- *A coherence index*: It measures the coherence of instinctive marks between a level and its lower levels.

$$I_{\text{coherence}} = \text{Moy} \left(\frac{|NI - NI_i|}{10 + \max(NI, NI_i)} \right); \quad I_{\text{correlation}} = \frac{\text{Min}(NI, NC)}{\text{Max}(NI, NC)}$$

NI : instinctive note of the level; NI_i : instinctive note of the i level; NC : calculated note of the level.

- *A final mark*: it is computed with the calculated mark, the global instinctive mark and the coherence index. The weaker is the coherence index, the closer the final mark is to the calculated mark.

With all these marks and indexes, the evaluator will be able to fix for each theme, criterion and sub-criterion, the final mark that he considers to be the right one (see figure 12).

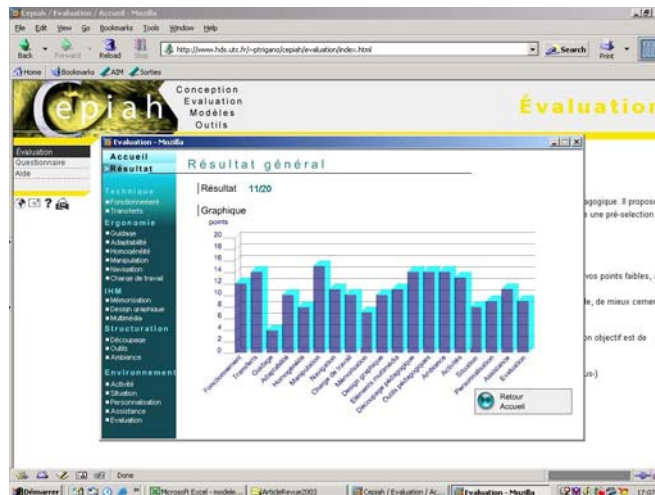

Figure 12. Global results

An important feature of our questionnaires is the explanation they give to the evaluator. Thus, we can notice three different information levels that can be used for evaluation: the explanation of each theme and of each meta-criteria, the new-formulation of the question and references to theoretical points and bibliography of the subject (figure 13). These levels guide the evaluator to formulate his choice without influencing him.

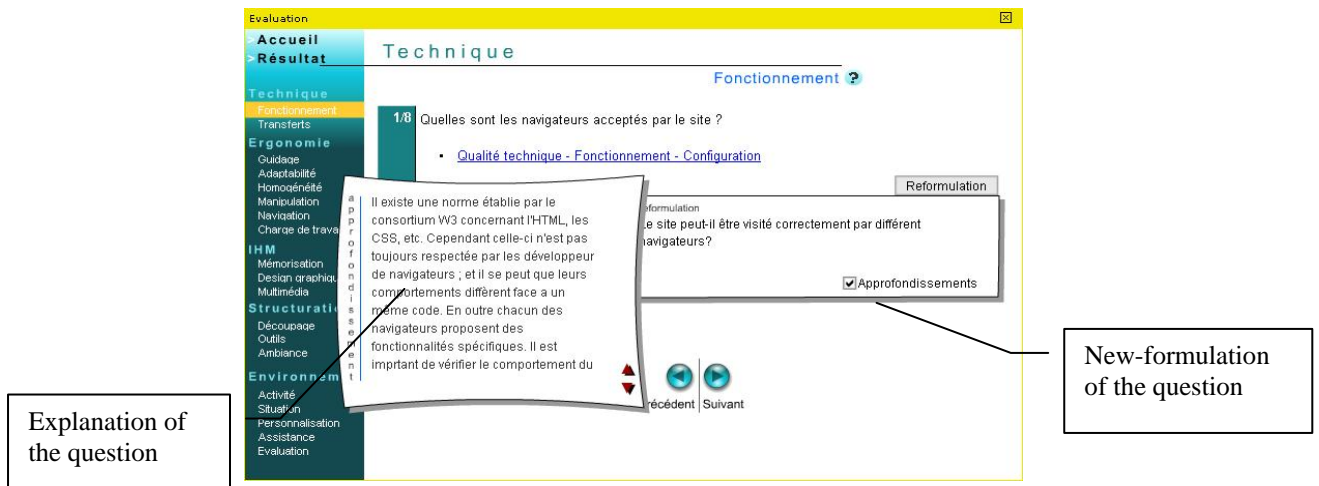

Figure 13. Example of question with new-formulation

Flexible navigation

We propose a “both way” navigation in order to reduce the eventual disorientation in our interactive guide and in order to help teachers, designing their web site to evaluate and to modify, if required, their prototype. Concerning the Evaluation section, the questionnaires are structured with a flexible navigation enabling the evaluator to have permanent access to the design section by the existing links between the two sections of the site at the themes and meta-criteria level. The Conception section also enables the user to navigate through different evaluation questionnaires using the indirect links that exit at the themes and meta-criteria level. For instance in figure 14, we show the explanation on the Pedagogical Division meta-criteria of the Pedagogical Structure theme from the Evaluation section. We notice the links towards the atomic information of the same meta-criteria from the Design section.

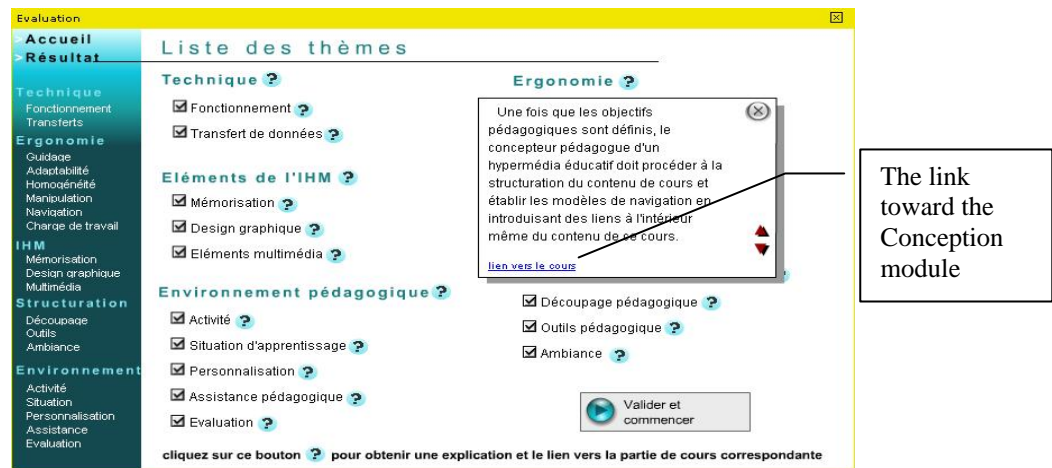

Figure 14. Navigation between the Evaluation and Conception sections

Validation of the EMPI module for the Evaluation of web prototype

Several versions of the questionnaire have been interactively realized, and several validations have been done. All these experiments are validations done during an iterative conception of our questionnaire. They have not been realized in real situation of use. Our goals were to validate calculation techniques of our method, to test stability of our evaluations (several evaluation of a same product, with various evaluators must produce same results) and to verify the usability of our dynamic questionnaire before submitting our method to real evaluators, teachers for example. Several important results appeared during these tests:

- The exponential notation and ponderations of some parts of the tree increase a lot the evaluation stability (Differences on minor points are erased). This also allows the detection of major defaults of the evaluated software.

- The use of digital marks as a unique form of results does not reflect all aspects of the evaluation. For example, it is difficult to see the difference between a bad characteristic and the lack of this point in the software.
- The comparison between subjective feelings and objective questions improves the evaluation quality.
- Finally, the use of a dynamic tree offers more flexibility in our method. It enables evaluations according to different levels of details, lowers time to fill in a questionnaire, and the opportunity to focus evaluation on precise points.

In a second step of validation, we wanted to check if our method is well adapted to our public- teachers. We have worked with teachers from several standards (school, high-school, university...) and from several domains (foreign language, computer science, mathematics, technical studies...).

Then, they used EMPI module for their evaluations and noted down all their comments. Such experiment had two goals: First, we wanted to check with the potential users, if our method is pertinent and easy to use. Secondly, it was important to test the limits of EMPI on a large set of pedagogical software in several pedagogical situations. We already obtained various results. The evaluation of software tools (text processing, data management...) did not produce really pertinent results.

Other experiments have been done in order to check if our results correspond to the ones coming from real users (teachers), during pedagogical process. We had interviewed several teachers using the same software ("Perfect your English 3eme", edited by the CNDP: The French National Center for Pedagogical Documentation). The results showed a good detection of ergonomic defaults actually detected by students.

Our goal was to make a set of more dynamic questions, in order to improve it and make it useful and easily usable. The use of an adaptive questionnaire, which dynamically takes into account the human needs, seems to be a good point. In the following section we present the experiment of a pedagogical Web site built with our SP/UL/FC method as well as an evaluation carried out with EMPI method (using the two first modules of our CEPIAH Method).

4. Validation

Technicians working in firms can follow along-the-life training in our university (UTC), in order to obtain an engineer diploma. To follow the engineer training, they first have to acquire basic skills they might have missed or forgotten through their initial training. These basics are taught during one year, while students keep working in their firms. Some of them can not be present in Compiègne for the courses and have to follow distance training.

4.1 Training in Computer Science

An application has been realised in the field of **teaching basics of algorithmic and computer programming**, in Pascal language, **on the web**. We have implemented a web site, integrating pedagogical simulations, lecturers, exercises (drills) and their solutions, and practical works. All these modules are integrated in an interactive and multimedia environment. Several ways of teaching this material have been tested, mainly based on books and videotapes. The main problem of these previous approaches was the lack of interactivity and adaptability of the supports to the specificity of each student.

We decided to submit an original device, mainly based on a Web site and a CD-ROM. We thought that the particular characteristics of digital supports could help in introducing ways of teaching that could bring in more interactivity and help in taking into account the personal needs of each student. Introducing closer tutoring can also treat this personalisation problem, what we jointly decided to do.

Device description

The following parts compose the device that the students have:

- A Web site enables the course consultation, to make exercises and auto-evaluations after each chapter. A controlled access to the correction of exercises makes it possible to follow the students' evolution in their training. They are expected to send their auto-evaluation results before being able to access the correction.
- A CD-ROM permits the off-line consultation of the courses' contents.
- A paper version presents a linear version of the lessons.
- Each month the students have one hour to meet the teacher and check if they well understood the concepts.
- The students can also ask questions more regularly by e-mail to a tutor.
- They also use a Pascal compiler to apply the algorithms they learn.

Evaluation

The first remark of the evaluation we can make is that our approach seems reasonably efficient, as the students learning this way obtained similar results to the exams as the students attending classical courses. In order to deeply evaluate our experiment we sent a questionnaire to the students. We used this questionnaire along with the remarks we already capitalized at the beginning of the training. This set of elements allows us pointing out the strengths and the lacks of our device. In the following paragraphs we submit a thematic development of the principles we identified as essential in our approach. Some of these aspects are not still completely treated, however they have been identified as important interpreting the current lacks of our device.

Multi-support environment

The Web site is used to access dynamic information, i.e. information that is expected to change in time. For instance, the exercises' corrections accessible when auto-evaluation has been sent or the exams memory that is refreshed each semester.

The CD-ROM documents are used for the advantages provided by a non-linear consultation. It makes it possible to have a personal approach in the reading choosing between various scenarios the teacher offers. It also allows more efficient consultation when doing exercises or programming algorithms, thanks to the links between concepts. Nevertheless the readability problem, linked to screen display, hinders hard concentration on texts.

Tutoring

An aspect that deeply emerges from our experiment is about teacher intervention in the learning process. Two main means exist to help the teacher in the follow-up of the students' works: The auto-evaluation (after each chapter the students are expected to send a form with the time they spent doing the exercises) and the meeting once a month between the students and the teacher. We observe that the students hardly work when the meeting comes closer, and the students confirm that the auto-evaluation principle help them in being regular and scheduling their work. Moreover, the students ask for more means to be followed in their learning process: For instance corrections and remarks about their works, indicators about exercises (difficulty, expected time to do them, etc.), more elaborated auto-evaluation (Multiple Choice Questions with automatic correction and work suggestion).

Tree experiments have been conducted. Two of them were carried out using a digital support and one was conducted based on a classical approach. As regarding the experiments of digital support, we have concluded that 90% of students were generally satisfied, but 40% of them missed the courses. In the same time, half of students preferred to more supervised, while the other half preferred to work independently. When using the digital support approach, the exam grades were overall good, ranging around the average of 8.8/20 and 15/20 (very good marks). While the grades of students using the classical approach, were evaluated above the average 9.5/20 and at 4/20 (very bad marks). The students that used the digital support received less low grades, a fact that proves a higher motivation for this approach.

4.2 Extension to twelve other trainings

After we have described the advantages of our work on the development of the interactive guide, we present the steps, which we had applied into the realization of the first validation of the prototype.

During the Multimedia Projects course at UTC, we have realized a validation (March – May, 2003) of the prototype with 3rd year at students Engineering. In fact, the students had to create the web sites for twelve different courses at UTC. During the first session of courses the person responsible of the Multimedia Projects gave to students a list of subjects proposed by different teachers (ten teachers) from UTC. These teachers want to have a web site for their courses. Beginning with the first course we presented the CEPIAH method to the students and our prototype was available online. We asked them to use our prototype during the period of realisation of their conception and development projects of web sites for different courses. The project realisation lasted for two months.

For the realization of this experience we had a group of about 45-50 students distributed into three groups of course, on three days (Group A on Wednesday, Group B on Thursday and Group C on Friday). Each group was divided into subgroups of three or four students. At the end of the projects we asked the students to fill out the evaluation questionnaire. This questionnaire was structured according to the three parts, which composed the interactive guide: there were questions on Design Help, Evaluation Help and Pedagogical Models.

We have analysed and represented the results under the graphic form using Excel. In fact, we had done a quantitative analysis of these results and averaged the responses of each student group. Figure 15 presents the average results of three groups. In the legend of the graphic the letter W represents the group of Wednesday, the letter T represents the group of Thursday and the letter F represents the group of Friday.

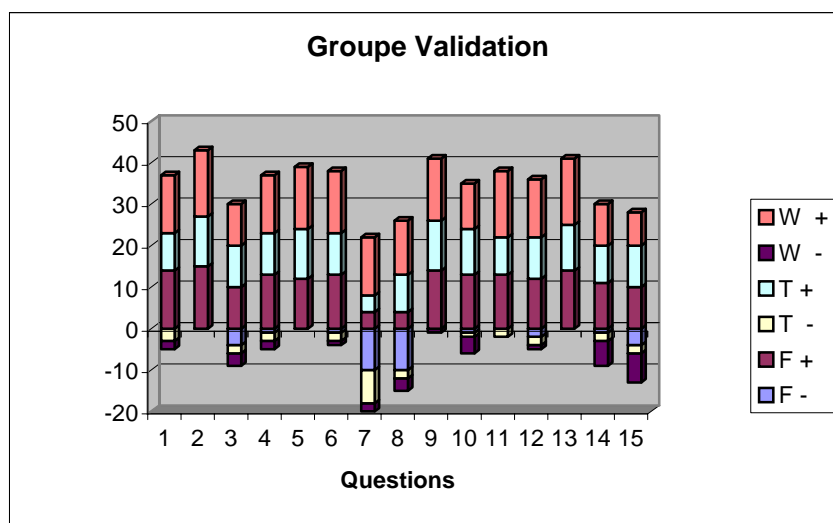

Figure 15. Validation

In general, we observe that the obtained resultants are mostly positive. However, we also observe the negative points for the questions (questions 7 and 8) about the significance of the “Bibliographic references “ into the Design Help module. We obtained the negative points from the groups of Thursday and Friday. In return, we observed that the group of Wednesday globally had more positive results. Note that the exterior teachers from CEPIAH project supervised the days of Thursday and Friday.

5. Conclusion and perspectives

We are now working on the third module proposing predefined sites models. The module proposes predefined site models that the authors may download and customise as they prefer. The customising concerns the course structure, projects, laboratories and also the content division and site navigation.

For the moment, we continue to develop this module, directing our research to the pedagogical scenarios design, starting from the learning theories fundamentals (Gagné, 1996) and also the Instructional Design Theories, using the current research results of D. Merrill (Merrill, 1999) and C. Reigeluth (Reigeluth, 1999).

In a short term, we expect soon the first validation of the Pedagogical Models by the teachers of our university from Compiègne (France).

6. Acknowledgements

This research has been financed by the STEF Pole (Evaluation of New Technology for Education) of the Picardie Region.

7. References

- Bastien, C., Scapin, D. (1995). Evaluating a user interface with ergonomic criteria, *International Journal of Human Computer Interaction*, Editor Lawrence Erlbaum Associates, Inc., Vol. 7, 105-121.
- Crozat, S. (2002). Ingénierie multimédia dans des contextes éducatifs, PhD Thesis, University of Technology of Compiègne, France.
- Cinema (2003). Conception et Intégration de Nouveaux Environnements Multimédias d'Apprentissage. Université du Montréal, Canada, 2003.
<http://www.fas.umontreal.ca/com/com3561/bta/ergo/frame1.html>

- Gagné, R., Medsker, K. (1996). *The conditions of learning: Training applications*, ASTD, Harcourt Brace College Publishers, USA.
- Gibson, J.J. (1979). *The Ecological Approach to Visual Perception*. Boston: Houghton Mifflin Eds.
- Hû, O., Trigano Ph. (1999). Considering subjectivity in software evaluation – Application for teachware evaluation, In J. Vanderdonckt & A. Puerta, editor, CADUI II, Computer Aided Desing of User Interfaces, Louvain, Belgique, 1999. Kluwer Academic Publisher. ISBN 0-7923-6078-8, page 331-336, 1999.
- Hû, O., Trigano, Ph. (2000). A tool for evaluation using dynamic navigation in a set of questions, in *Proceedings of the International Workshop on Tools for Working with Guidelines TFWWG'2000*, Springer-Verlag (Eds.), London, 2000.
- Lamrous, S., Trigano, P. (1999). Assistance for Sensory Analysis of Products in Design with the Automatic Indexing Methods in Full-Text, in *Proceeding of CSCWD99 4th International Workshop on Computer Supported Cooperative Work in Design*, ISBN 2-9139-2300-3, Compiègne, France, 1999.
- Linard, M., Zeiliger, R. (1995). Designing an interface in an educational context : first steps to a principle approach, in *Proceedings 5th Conference INTER'ACT 95*, IFIP, Lillehammer, K. Norby, P. Helmersen, D. Gilmerer, S. Arnesen (eds), Chapman&Hall, London, page 401-404, 1995.
- Linard, M., Belisle, C., Zeiliger, R. (1998). Reconciling information processing and activity theories : HELICES, a foundation model for creating cognitive artefacts, in *Proceeding of ISCRAT98, International Society for Cultural Research and Activity Theory*, 4th Congress, Aarhus, DK, 1998.
- Merrill, D. (1999). Instructional Transaction Theory: Instructional Design Based on Knowledge Objects, In Charles M. Reigeluth (Ed.). *Instructional Design Theories and Models: A New Paradigm of Instructional Technology*. Lawrence Erlbaum Associates, 1999, page 397-423.
- MEDA (1990). *MEDA, Evaluer les logiciels de formation* , Les Editions d'Organisation (Eds.), Paris,1990.
- Nielsen, J., (2000). *Conception des sites Web: l'art de la simplicité*, CampusPress (Eds.), France, 2000.
- Park, I., Hannafin, M.J. (1993). *Empirically-based guidelines for the design of interactive media*, in Educational Technology Research en Development, vol.41, n°3, 1993.
- Preece J., Rogers Y. (1996). *Human Computer-Interaction*, Addison-Wesley (Eds.), 1996.
- Ravden, S.J., Johnson, G.I. (1989). *Evaluating usability of Human-Computer Interfaces : a practical method*, Chichester, England: Wiley, 1989.
- Reigeluth C. M. (1999). The Elaboration Theory: Guidance for scope and Sequence Decisions in *Instructional Design Theories and Models, Volume II: A New Paradigm of Instructional Theory*, Editor Mahwah, NJ: Lawrence Erlbaum Associates, 1999, page 5-28 .
- Sabry-Ismail, L., Roisin, C.E, Layaïda, N. (1997). Navigation in structured multimedia document using presentation context, in *Proceeding of H²PTM'97*, (Eds) Hermes, France, 1997.
- Sanchez, J., Lumbreras, M. (1997). *Hyperstories : Interactive narrative in virtual worlds*, in Proceeding of H²PTM'97, Hermes, France, 1997.
- Scapin, D., Bastien, C. (1997). *Ergonomic criteria for evaluating the ergonomic quality of interactive systems*, Behavior & Information Technology Vol. 16, page 226-231.
- Type, J.H. Mc, Frommer, W.D. (1985). *Effects on character / background color combination on CRT character lisibility*, HFS'85, Proceedings of human factor society, Vol. 1, 1985.
- Vanderdonckt, J. (1994). « Guide ergonomique de la présentation des applications hautement interactives », *Presses Universitaires*, Namur, 1994.
- Vanderdonckt, J.(1999). Development Milestones Towards a Tool for Working with Guidelines, *Interacting with Computers, The Interdisciplinary Journal of Human-Computer Interaction, Special issue: Tools for working with Guidelines*, 12 (2), pp. 81–118, 1999.
- Vivet, M. (1996). Evaluating educational technologies : Evaluation of teaching material versus evaluation of learning , *Proceedings. Lecture Notes in Computer Science 1108* Springer 1996, ISBN 3-540-61491-5, page 37-38.
- W3 Educatif (2003). Université Laval, Canada, 2003, <http://apctic.ulaval.ca/guidew3educatif>